



From the Sugar Platform to biofuels and biochemicals

**Final report for the European Commission
Directorate-General Energy**

N° ENER/C2/423-2012/SI2.673791

April 2015

V2.1

A consortium led by

E4tech (UK) Ltd

with

**Consorzio per la Ricerca e la Dimostrazione
sulle Energie Rinnovabili (RE-CORD)**

and

**Stichting Dienst Landbouwkundig
Onderzoek, Wageningen University and
Research Centre (WUR)**



Contents

Abstract	5
Executive Summary	6
1. Introduction	11
1.1. Background	11
1.2. Objectives	12
1.3. Project scope.....	12
2. Mapping of the different possible pathways	13
3. Assessment of technology development status	25
4. Market size	31
5. Case studies.....	33
5.1. Selection criteria	33
5.2. Acrylic acid	34
5.3. Adipic acid.....	38
5.4. 1,4-Butanediol (BDO).....	43
5.5. Farnesene.....	47
5.6. 2,5-Furandicarboxylic Acid (FDCA).....	51
5.7. Isobutene	54
5.8. Polyhydroxyalkanoates (PHAs)	58
5.9. Polyethylene (PE)	63
5.10. Polylactic acid.....	66
5.11. Succinic acid.....	72
5.12. Summary	75
6. Current European industry competitiveness	78
6.1. Competiveness assessment criteria.....	78
6.2. Competing regions assessment	80
6.3. European competitiveness	93
7. Assessment of technology opportunities and barriers	96
7.1. Pre-treatment of lignocellulosic biomass	96
7.2. Downstream conversion of sugars	102

8.	R&D gaps and industry needs	107
8.1.	Technical gaps in research	107
8.2.	Non-technical barriers and gaps in support policy	111
	Appendix A - Literature survey	119
	Appendix B - Assessment of suitable feedstocks	123
	Appendix C - Product descriptions	131
	Appendix D - Potential impacts of lower crude oil prices	143
	Appendix E - Safety issues regarding the use of micro-organisms in biofuels processing.....	146
	Appendix F - Development of criteria for assessing socio-economic impacts.....	152
	Appendix G - Glossary of acronyms.....	154
	Appendix H - References	159

Copyright notice: Copyright © 2015 European Union. All rights reserved. Certain parts are licensed under conditions to the EU.

Disclaimer: The information and views set out in this report are those of the authors and do not necessarily reflect the official opinion of the Commission. The Commission does not guarantee the accuracy of the data included in this study. Neither the Commission nor any person acting on the Commission's behalf may be held responsible for the use which may be made of the information contained therein.

Authors:

E4tech (UK) Ltd

Richard Taylor, Lucy Natrass, Geneviève Alberts, Paul Robson, Claire Chudziak, Ausilio Bauen

Consorzio per la Ricerca e la Dimostrazione sulle Energie Rinnovabili (RE-CORD)

Ilaria Marsili Libelli, Giulia Lotti, Matteo Prussi, Renato Nistri, David Chiaramonti

Stichting Dienst Landbouwkundig Onderzoek, part of Wageningen University and Research Centre (WUR)

Ana López Contreras, Harriette Bos, Gerrit Eggink, Jan Springer, Rob Bakker, Rene van Ree

Referencing: please reference this study as:

E4tech, RE-CORD and WUR (2015) "From the Sugar Platform to biofuels and biochemicals". Final report for the European Commission, contract No. ENER/C2/423-2012/SI2.673791

E4tech (UK) Ltd
83 Victoria Street
London SW1H 0HW
UK

Tel: +44 20 3008 6140
Fax: +44 20 3008 6180

www.e4tech.com

Incorporated in England and Wales, Company no. 4142898
Registered address: 60-62 Old London Road,
Kingston upon Thames, Surrey, KT2 6QZ, UK

Abstract

Numerous potential pathways to biofuels and biochemicals exist via the sugar platform¹. This study uses literature surveys, market data and stakeholder input to provide a comprehensive evidence base for policymakers and industry – identifying the key benefits and development needs for the sugar platform.

The study created a company database for 94 sugar-based products, with some already commercial, the majority at research/pilot stage, and only a few demonstration plants crossing the “valley of death”.

Case studies describe the value proposition, market outlook and EU activity for ten value chains (acrylic, adipic & succinic acids, FDCA, BDO, farnesene, isobutene, PLA, PHAs and PE). Most can deliver significant greenhouse savings and drop-in (or improved) properties, but at an added cost to fossil alternatives.

Whilst significant progress has been made, research barriers remain around lignocellulosic biomass fractionation, product separation energy, biological inhibition, chemical selectivity and monomer purity, plus improving whole chain process integration.

An assessment of EU competitiveness highlights strengths in R&D, but a lack of strong commercial activity, due to the US, China and Brazil having more attractive feedstock and investment conditions. Further policy development, in particular for biochemicals, will be required to realise a competitive European sugar-based bioeconomy.

¹ IEA Bioenergy Task 42 defines ‘platforms’ as “*intermediate products from biomass feedstocks towards products or linkages between different biorefinery concepts or final products*”. Platforms are at the heart of the biorefinery concept, and the most important feature in the classification of a biorefinery. There are numerous examples of platforms, such as oils, syngas, hydrogen, pulp, lignin and C6 sugars. Throughout this study, the term ‘sugar platform’ is taken to mean the collection of platforms that involve any combination of C5, C6 and/or C12 sugars, that exist as intermediates within pathways from biomass feedstock towards final biofuel or biochemical products.

Executive Summary

There are a very large number of possible combinations of feedstock, pre-treatment options, sugars, conversion technologies and downstream processes that can be followed as potential pathways to make biofuels and biochemicals. This comprehensive study therefore sets out to map potential value chains based on the sugar platform, and assess them on their development status, economic competitiveness, environmental sustainability and market potential. Industry input was also gathered via two stakeholder workshops covering the competitiveness of the EU industry vs other world regions, the key research gaps and possible policy developments. This study is therefore to act as an evidence base for policymakers and stakeholders to identify opportunities, their key benefits and development needs.

The IEA Bioenergy Task 42 Biorefinery Classification System was used for mapping different pathways. A high-level summary of the chains considered is shown below in Figure 1 – with nine detailed maps available within Section 2 of the report. The report is focused on a more limited (94) number of products, since the project scope covers routes that are under development with industry support, or already commercialised with the potential for growth.

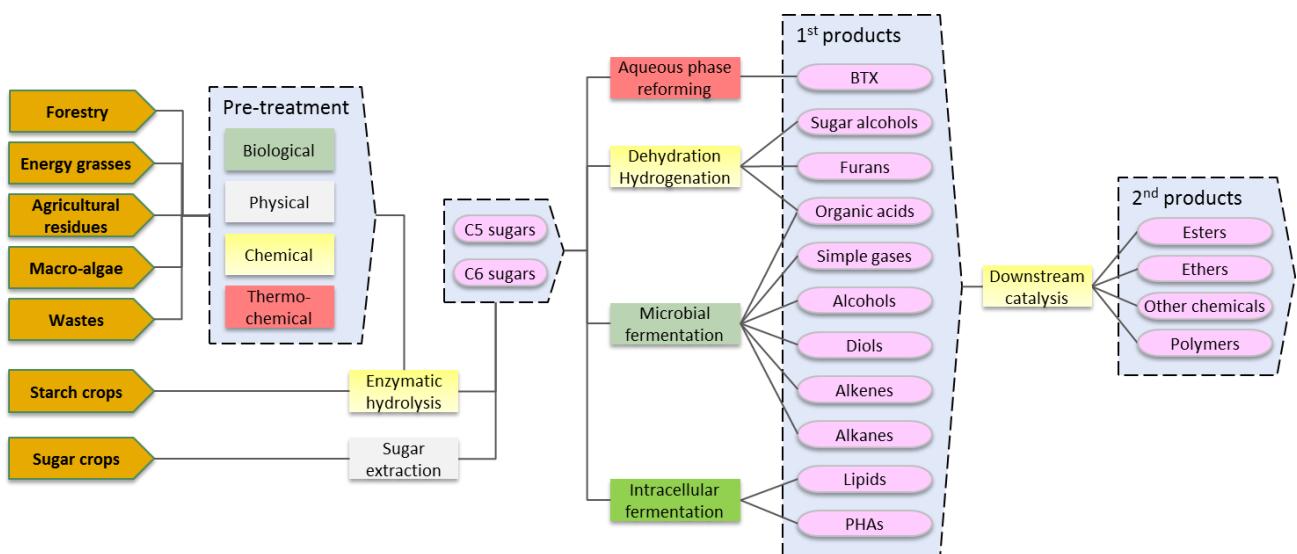

Figure 1: High-level representation of pathways via the sugar platform

Based on available literature, interviews and industry reports, a database of biochemical and biofuels companies was created, collecting names, countries, products made, process technology used, Technology Readiness Level (TRL), current total production capacity, location and type of facilities. Most R&D labs and pilot plants are located in Europe and North America, with North America having significantly more demonstration facilities. Asia (mainly China) has a good manufacturing base of high TRL products, and South America has a few early commercial projects.

TRLs and company results for all 94 products are given in Section 3. There are however 25 products of particular interest, given the level of industry activity, and as highlighted by US DOE's "Top10" biochemicals and IEA Bioenergy Task 42 reports – the majority are primary products (first step after sugars), with some key intermediates added (e.g. ethylene). Figure 2 clearly shows the "valley of death" between those products at pilot or lab-scale (TRL 5 or lower), and another cluster of commercialised products (TRL 8-9).

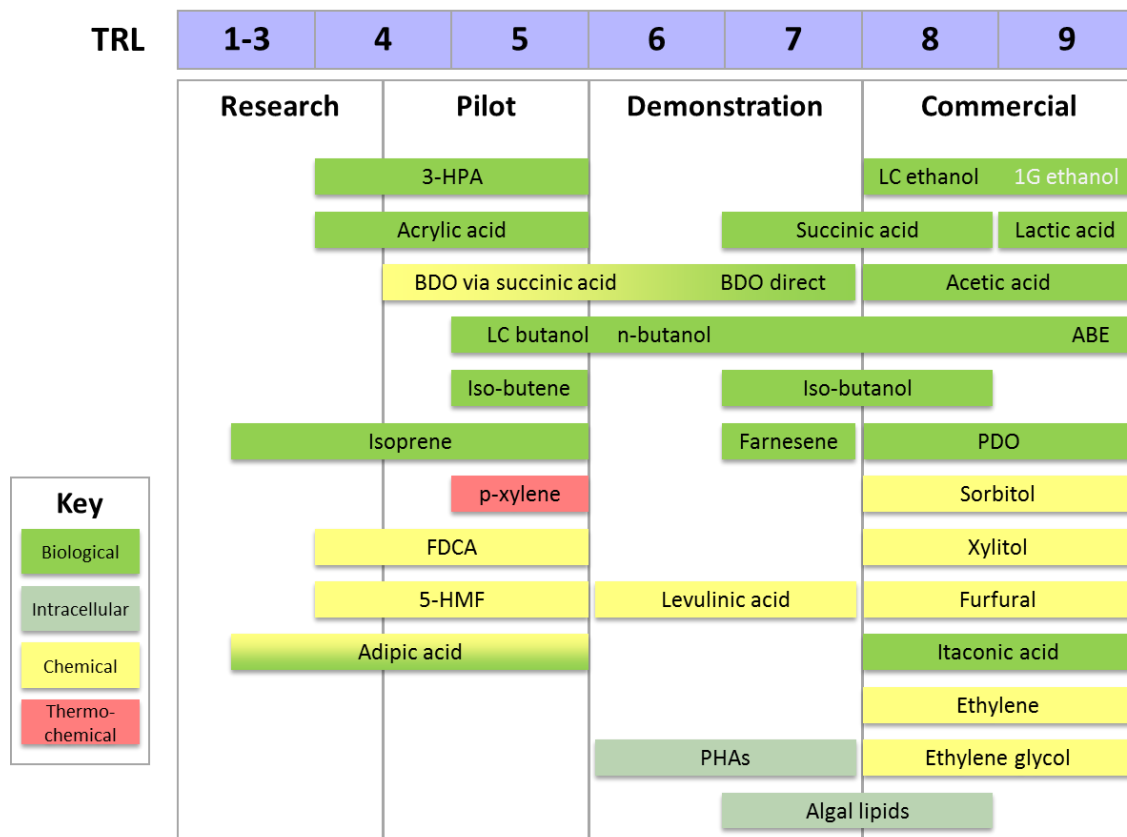

Figure 2: Commercialisation status of the 25 selected sugar platform products

A new conversion technology usually follows a development pathway from the lab, through piloting, then demonstration, before building a commercial plant – this is typical for most bio-based products (particularly biological routes). This process can be accelerated by skipping steps, when conventional downstream processes are used (e.g. using drop-in intermediates). The number of years for a bio-product to reach commercialisation depends heavily on economics (value proposition), drop-in vs. non drop-in (existing demand and infrastructure), conversion technology type, and partnerships (up/downstream supply chain integration). Successfully reaching TRL8 from TRL5 could take around 10 years in a supportive policy environment – but some routes may never be commercialised due to unattractive economics.

From the available literature and access to industry data, Section 4 collected indicative prices, global production volumes and market sizes for the selected 25 products, along with their fossil counterparts (where applicable). Prices often vary between regions, and certainly over time – the last 6 months has seen a 50% fall in the price of crude oil, which will dramatically lower the fossil reference prices given. Bio-ethanol is the dominant sugar platform product, followed by much smaller, but still significant, markets for n-butanol, acetic acid and lactic acid. Xylitol, sorbitol and furfural also show significant markets for chemical conversion of sugars, without petrochemical alternatives. The smallest bio-based markets are, as is to be expected, those of the earliest stage products, such as 3-HPA, acrylic acid, isoprene, adipic acid and 5-HMF. If economically competitive, many bio-based markets could grow to exceed the current demand for the fossil-based product, and expand into new markets, replacing other products.

Ten products were then selected as detailed case studies in Section 5; based on being at least TRL 5, with at least one EU developer, and significant potential for market expansion. Each case study is a detailed review

of the bio-based product (description and pathways), the actors involved in its production (EU and rest of world, discussing plants and partnerships), the value proposition (production economics, greenhouse gas savings and physical properties), and the expected market outlook (expected growth rates, new volumes and markets opened up). These case studies have been through industry reviews, and exist as standalone four page documents. A summary is given in Table 1 below^{2,3}.

Table 1: Summary of case study actors, markets, costs and emissions

Bio-based product	Actors	Key markets and value proposition	Cost relative to fossil alternative	GHG saved vs. fossil alternative
Acrylic acid	BASF-Cargill-Novozymes (EU) OPXBio-Dow (USA). Focus for both partnerships is on 3-HPA route	Drop-in replacement for a widely used chemical intermediate	20 - 48% better than the fossil-based when commercial	>70%
Adipic acid (ADA)	Biochemtex and DSM (EU) Some US projects have reached pilot scale (Rennovia, Verdezyne).	Drop-in replacement meeting demand for nylon 6,6 and polyurethanes	Expected to be cost competitive (lower capex and utilities)	70-95%, depending on N2O intensity of fossil process
1,4 – Butanediol (BDO)	Genomatica (USA) main actor. BASF, Novamont, DSM, Biochemtex making BDO and PBT based on Genomatica technology. JM-Davy BDO is via Myriant’s succinic acid	Drop-in replacement for fossil BDO. BDO is used to make GBL, THF and PBT	15-30% lower than fossil and competitive at an oil price of 45 \$/barrel	70-117% depending on the process and electricity co-product substitution
Farnesene	Only one market player, US-based Amyris. There are no major European players.	Moisturiser emollients, durable easy-cast tyres, and jet fuel properties consistent with C15 iso-paraffin	Already attractive in emollients; close to market in tyres; high compared to jet	Up to 80% compared with fossil jet
2,5 furan-dicarboxylic acid (FDCA)	Development led by Avantium in the EU. Corbion Purac, AVA Biochem and Novozymes also active in this space in Europe	Substitute for TPA to make new class of polyethylene furanoate (PEF) polymers. Application in drinks bottles as superior gas barrier vs PET	High since at small scale, yet to be commercialised	45-68%
Isobutene	Small number of players, only Global Bioenergies and Lanxess in EU. <i>Gevo and Butamax are the main developers of isobutanol</i>	Rubber for automotive, and as a precursor for fuel & lubricant additives and biofuels. Might be used as food antioxidant	Could be profitable under high oil price market conditions	20-80%
Poly-hydroxy-alkanoates (PHAs)	Modest EU activity compared with China and the Americas. Biomer and Bio-on are the key EU players. Metabolix the largest US player	Fully biodegradable, niche use in sutures. Tuneable properties means could be used in most aspects of plastics industry	High costs. May fall via integration with sugar mills	20% with starch feedstocks, 80% with sugarcane and 90% with LC feedstocks
Poly-ethylene (PE)	Braskem in Brazil is the only commercial scale producer	Drop-in replacement for fossil PE, the most commonly produced plastic globally – main application in packaging	Sold at 30-60% above to fossil PE. Higher volumes may see price differential fall	>50% using sugarcane. Higher savings with LC feedstocks
Poly-lactic acid (PLA)	A few large industry participants; NatureWorks (USA) and Corbion Purac (NL) dominate PLA and LA production respectively. ~9 other EU producers of PLA and LA.	Bio routes preferred to fossil. PLA suitable for packaging, insulation, automotive and fibres. Durable, degradable, easily composted, low toxicity	Costs unconfirmed, but improved at scale. Slightly higher market price than fossil PS, PP and PET.	30-70% vs fossil PP, PS and PET. Could rise to 80% with improved conversion
Succinic acid	2 main actors in Europe (Reverdia, Succinity) and a further 2 globally (BioAmber, Myriant)	Drop-in replacement for fossil, and near-drop-in for adipic acid in resins, plasticisers, and polyester polyols	Equal to fossil costs since 2013. Fossil succinic acid now only niche	75-100+%, depending on feedstock production and grid intensity

² Cost comparisons are based on publically available data from 2013-2014, hence may not reflect dramatic fall in recent crude oil prices

³ In every case, GHG savings are highly dependent upon the choice of feedstock, and the methodology used in the individual references

In Section 6, the competitiveness of the European industry versus other world regions has been assessed based on seven key criteria: Policy, Financing, Public perception & consumer demand, Level of R&D activity, Level of commercial activity, Feedstock availability & cost, plus Other production costs. The status of EU competitiveness versus the US, Brazil and China is summarised below in Table 2, where “A” denotes a world leading strength and “C” denotes a competitive weakness.

Table 2: EU competitiveness vs. the US, Brazil and China (A = strong, B = average, C = weak)

Criteria	EU	US	Brazil	China	Notes
Policy	C	A	B	B	EU lacks long-term stable mandates in the biofuel sector, whereas biochemicals remain un-incentivised. US BioPreferred Programme is bringing biochemicals and materials to market, and RFS LC biofuel targets remain high, but very undersupplied. Brazil and China (plus other Asian nations) have some mandates for bioethanol and/or products.
Financing	B	A	B	A	Cost of capital is typically lowest in China, and highest in Brazil. The DOE and BNDES provide significant loan guarantees to bio-industrial investments in the US and Brazil respectively – but lack of a similar scheme in the EU is seen as a key financing issue by developers.
Public perception & consumer demand	B	B	B	B	Dependent on policy and information campaigns. 1G biofuels have come under fire due to food and ILUC concerns - only a few biochemicals have attracted similar attention. Perception varies by feedstock (e.g. palm oil). US and EU customers value “natural”, “green” or locally grown products. Some brand owners using bio-based packaging, either for improved properties or for marketing/product differentiation. Sustainability requirements for biofuels do not exist for bio-chemicals (within EU or abroad), only some suppliers voluntarily report.
Level of R&D activity	A	A	B	B	EU & US knowledge base well established, with significant research resources – hence many companies conduct R&D in these regions. China has focused more on manufacturing, and Brazil on cultivation.
Level of commercial activity	C	B	C	A	Existing biochemical manufacturing capacities are strongest in China. Activity in Brazil limited to a few early commercial plants. US a leader in biofuel/chemical demonstration facilities. EU manufacturing reflects a focus on down-stream processes, like polymerisation, rather the basic building blocks. Few manufacturers. First commercial LC ethanol plants exist in all four regions, but with efforts being led by the US. Other LC routes are currently very limited.
Feedstock availability & cost	B	A	A	B	For first generation crops, the most important feedstocks are EU wheat, US corn, Brazilian sugarcane and Chinese corn. For LC crops, EU generally shows slightly higher feedstock costs, although has the infrastructure for imports. The US also has a well-integrated and mechanized agricultural sector, but can supply agricultural and forestry residues at more competitive costs. Brazil has decades of agricultural logistics experience, with bagasse and trash availability increasing. China and SE Asia have huge potential, but need to mechanise residue collection.
Other production costs	C	B	B	A	The EU has high energy and labour costs, which leads to high direct operational costs. Brazil has higher energy costs in general, and the US has higher average wages, but the EU scores second highest on both. The US has lowest energy costs, and China the lowest average wages.

Section 7 starts by discussing the opportunities and barriers faced by the different technologies involved in the initial conversion of biomass to sugars, since this pre-treatment is common to all lignocellulosic value chains, and yet is still one of the most expensive steps. Technical obstacles in existing pre-treatment processes include insufficient separation of cellulose and lignin, formation of by-products that inhibit downstream fermentation, high use of chemicals and/or energy, high costs for enzymes (although falling

rapidly), and high capital costs for pre-treatment facilities. Opportunities, barriers and mitigations are discussed for each of the different pre-treatment technologies, along with TRL and developer activities.

8 additional downstream bio-based polymer pathways (PLA, PET, PBS, PEF, PE, PMMA, PIP) were added to the 25 selected products, in order to evaluate their opportunities and production barriers, along with a discussion of potential mitigation activities. The majority of the barriers faced by alcohol production processes either relate to the energy or economic cost of product separation, and the low concentrations of end-products in the fermentation broth due to toxicity effects of the end products on the micro-organisms. Organic acid barriers are more heavily focused on purities, reducing unwanted by-products and the need to improve selectivity of the processes (particularly chemical catalytic routes). Biopolymer developments are particularly focused on monomer purity, production cost vs. the fossil counterfactual, as well as the ability to use drop-in molecules and/or improve product properties.

The key research gap themes, where insufficient R&D efforts are being focused on overcoming technical barriers, are discussed in more depth in Section 8.1. These include:

- Lignocellulosic biomass fractionation: Substitution of corrosive chemicals, reducing the inhibition of downstream fermentation, improving hydrolysis efficiency via tailored enzyme development, and introducing processes that are flexible with respect to feedstock
- Increasing product yields and reduced by-product formation in biological processes, reducing energy demand for product separation, and obtaining higher purity lignocellulosic sugars for use in chemical processes
- Developing purification processes to obtain high purity monomers, development of novel polymers, scale-up of polymer production
- Improved process integration along whole technology chain (feedstock to product) incorporating different disciplines, development of consolidated processing approaches, and consideration of interfaces between biological and chemical steps

The study concludes with an assessment of non-technical barriers. The Bio-TIC project has done considerable work in understanding this area and preparing recommendations for improvement. Section 8.2 therefore summarises some of the key findings from Bio-TIC, plus inputs from stakeholders at the project workshops. Categories of non-technical barriers have been prioritised into their importance to the sugar platform as follows:

1. Demand side policy (most important)
2. Public perception & communication
3. Investment & financing
4. Feedstock
5. Other barriers (least important)

EU policies affecting the sugar platform have been listed, with their scope, budget and issues they help to overcome. The main policies or funding measures discussed include: Horizon 2020, the Bio-Based Industries PPP, European Industrial Bioenergy Initiative, EU ETS, NER300, European Investment Bank, RED, FQD and Sugar quotas. Potential policy improvements are discussed, including longer-term stability of mandates, setting biomass use between fuels and chemicals on a level playing field, incentivising biomass production, creating a clear Europe-wide communication campaign, dis-incentivising fossil-derived products, improving access to capital and loan guarantees, and simplifying available funding mechanisms.

1. Introduction

1.1. Background

The Renewable Energy Directive (RED) and Fuel Quality Directive (FQD) are the two main policies driving biofuel deployment in the EU out to 2020. The last few years have seen a plateau in the EU's consumption of biofuels, and minimal deployment of advanced biofuel routes, primarily due to policy uncertainty surrounding Indirect Land Use Change (EurObserv'ER, 2014). However, investment in biochemicals and biopolymer production capacity is starting to increase significantly, albeit from a very low base. Rapid technical progress is also being made in regions such as the US, Asia and Brazil, with a particular focus on facilities using readily available sugar and starch feedstocks (Nova, 2013).

With the nearing commercialisation of lignocellulosic sugar pre-treatment technologies (and other thermochemical options), sugars could be made from a wide variety of woody material, wastes and other residues. Many of the routes onwards from sugar are then expected to use micro-organisms (often genetically modified) to generate finished products or useful intermediates. There are therefore a large number of possible combinations of feedstock, pre-treatment options, sugars and conversion technologies that can be followed as viable pathways – in order to produce an even longer list of final biofuels or biochemicals and biopolymers. Even following a single pathway from one feedstock to one final product (via sugars), different technologies at different stages of commercialisation are required. The associated co-product streams also mean that integrated biorefinery concepts (multiple input and output synergies) could play an important role in the sugar platform.

Today there are scattered examples of studies assessing specific chains or components. No-one has yet conducted a comprehensive study that maps out all the potential value chain options, assessing them on a common basis for a number of important aspects – such as: development status, economic competitiveness, environmental sustainability and market potential – in order to answer what is achievable within the next 5-10 years. A deeper understanding of the sugar platform would therefore be very valuable in assisting policy makers and industry stakeholders to identify technology opportunities, their key benefits and how their development needs can best be supported.

1.2. Objectives

This independent study has therefore set out to provide the following evidence base regarding the production of biofuels and biochemicals from the sugar platform:

- An assessment of the **status of the different pathways**, mapping their suitable feedstocks and potential products, and identifying technology opportunities, enablers and barriers to commercialisation
- An assessment of **European developments, and how competitive** our industry is likely to be versus other world regions
- For a defined set of case studies, an analysis of **production costs, and comparison of business cases** against current technologies in the market
- A **sustainability assessment** using key criteria such as GHG emissions, land use, safety issues and other environmental and socio-economic factors
- The identification of current **research gaps and R&D needs** – with a focus on recommending measures that will accelerate the introduction of large scale demonstration facilities

1.3. Project scope

The primary focus of the study is the conversion of sugars to biofuels and biochemicals via novel pathways, with an emphasis on applied research and its commercialisation not basic research. Combined with the need to assess what is possible or realistic within the next 10 years, the study therefore concentrated on the developments from pilot scale (and above) within companies, and not academia. As a result:

- Ethanol produced from “first generation” feedstocks (for example corn, wheat, sugarbeet and sugarcane), having been commercialised and deployed at scale, is considered out of the study scope.
- Lignocellulosic ethanol is nearing commercialisation, with first-of-a-kind commercial plants built or currently under construction, and is therefore within the scope of the study, although a great deal is known about this industry already, and therefore less effort is afforded it compared to more novel pathways to different fuels and chemicals.
- The emphasis of the study is on conversion from sugars, not to sugars (unless particularly novel or high impact), and therefore much greater effort has been dedicated to the downstream conversion of sugars rather than biomass pre-treatment processes and sugar production.
- Back-end upgrading technologies, such as alcohols to jet/diesel are considered in scope. These routes can be based on the sugar platform, although they take as their input an already finished fuel (e.g. sugar-based ethanol).
- Other non-sugar based platforms producing intermediate vectors such as vegetable oils, syngas, pyrolysis oils, lignin or CO₂ are out of scope of this study. For this reason, photosynthetic microalgae producing oil are not in scope - algae will only be included if it is a carbohydrate feedstock, or a heterotrophic "sugar-to-product X" conversion technology.

2. Mapping of the different possible pathways

This section of the report presents the different possible combinations of feedstocks, pre-treatment technologies, sugars, conversion technologies and downstream processing to finished biofuels, biochemicals and bio-based polymers. Pathways for the conversion of feedstocks to fuels and chemicals may be categorised according to the following three main stages:

- Pre-treatment from feedstock to sugars
- Conversion from the sugar platform to a useful product
- Upgrading of any intermediate products to final biofuel/biochemical

Throughout this section, we use the IEA Bioenergy Task 42 Biorefinery Classification System to define raw materials, platforms and output products, and also follow the same conventions on the construction of flowchart diagrams. These shapes are given below in Figure 3, noting that a slightly different colour set has been used to help distinguish between the different conversion processes.

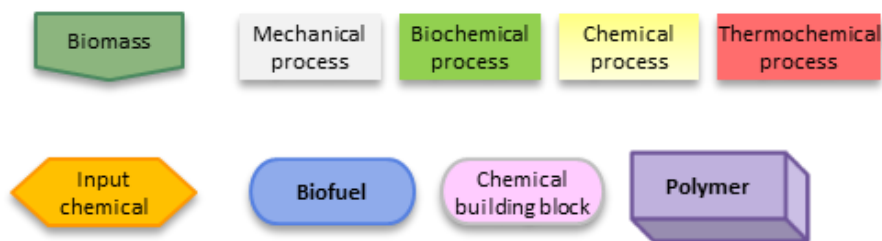

Figure 3: Legend used for flowchart maps

The starting biomass feedstocks shown in Figure 4 have been grouped by agricultural residues, forestry, wastes & algae, starch crops and sugars crops. Different levels of pre-treatment are required for the different groupings, with sugar based crops needing minimal processing, starch crops needing to undergo enzymatic hydrolysis to break the starch into sugars, and lignocellulosic feedstocks requiring much more extensive pre-treatment to free cellulose and hemicellulose fractions from the lignin.

The pre-treatment technologies are grouped by process type, with biological, mechanical, chemical and thermo-chemical process options shown. Ultimately, they are all producing accessible cellulose and hemicellulose materials that will undergo hydrolysis.

The sugars in Figure 4 are also grouped, with glucose, fructose and galactose being the most common hexose sugars (C6 sugars with six carbon atoms), xylose, pentose and ribose being the most common pentose sugars (C5 sugars with five carbon atoms), and lactose, sucrose and maltose being the most common disaccharides (C12 molecules containing two hexose sugar units). Larger molecules such as oligosaccharides and polysaccharides (e.g. starch) are not included within the sugar platform, as they are not easily digestible by a wide range of organisms, whereas monosaccharides and disaccharides are very widely converted. The term 'sugar platform' is therefore defined as any combination of C5, C6 and/or C12 sugars that exists within a pathway from biomass feedstock towards final biofuel or biochemical products.

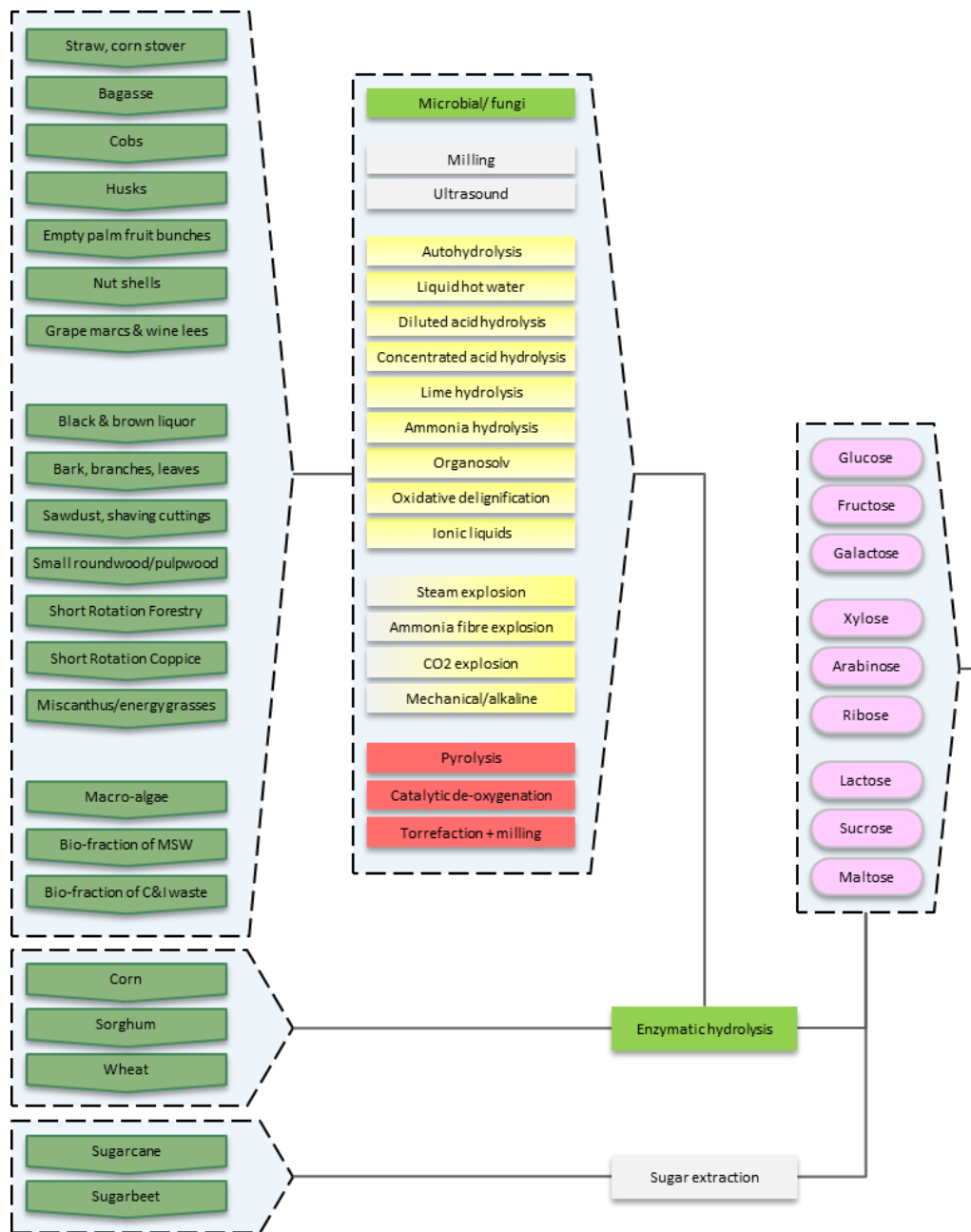

Figure 4: Mapping of feedstock and pre-treatment options to sugars

Once a primary product from sugars has been produced and extracted, there are then an even larger number of downstream process options available. In several cases these primary compounds are also end products (e.g. ethanol, isobutanol), but they have substantial use as building blocks to other end products. As stated by de Jong et al. (2012) *“From a technical point of view, almost all industrial materials made from fossil resources could be substituted by their bio-based counterparts”*. Ultimately, it comes down to which conversion processes are most efficient and economically viable as to which routes are likely to be followed and deployed.

Bio-based bulk chemicals, fuels and polymers include historic items with a long history of bio-based production (such as citric acid), recently introduced products (such as propylene glycol), and products currently in the demonstration or pilot stage of development (e.g. FDCA). The report is therefore focused

on a more limited (94) number of products with the specified project scope, either in the development pipeline with supporting industry interest, or already commercialised with the potential for strong growth (de Jong et al., 2012; Nova Institute, 2013).

Figure 6 to Figure 12 therefore present the most likely routes arising from each of the highlighted primary product (green “feedstocks”), and also cover at least one method of producing each fuel, chemical and polymer within the list of 94 materials. However, it should be recognised that many of these chemical downstream chains could be inverted, so that the intermediate product becomes the final product, and the processes reversed (hydration/dehydration), hence the direction of travel in many cases does not have to be only left to right.

The majority of uses of sugar are via microbial fermentation to produce alcohols, organic acids, alkenes, lipids and other chemicals, as highlighted in Figure 5. This conversion can be using bacteria, fungi or yeast, genetically modified or not, in a variety of process conditions (e.g. low/high pH, anaerobic/aerobic, nutrient rich/deprived). The product of interest can also be produced intra-cell (and require lysis/death of the cell to extract, usually via solvents), or extra-cell (and require separation/extraction from the fermentation broth). This extraction step is assumed to be part of the conversion technology.

We note that the list of fermentation products given in Figure 5 is not exhaustive; however it does cover all the initial intermediate products of interest given those fuels, chemicals and polymers discussed later in this report. The other routes using sugars are either:

- Chemical based processes (e.g. hydrogenation of glucose to sorbitol, oxidation of glucose to gluconic then saccharic acid, acid dehydration of xylose to furfural). These options are expanded upon in Figure 11 and Figure 12.
- Thermo-chemical processes (e.g. Virent’s aqueous phase reforming to BTX and a mix of other ketones, furans, acids and paraffins).

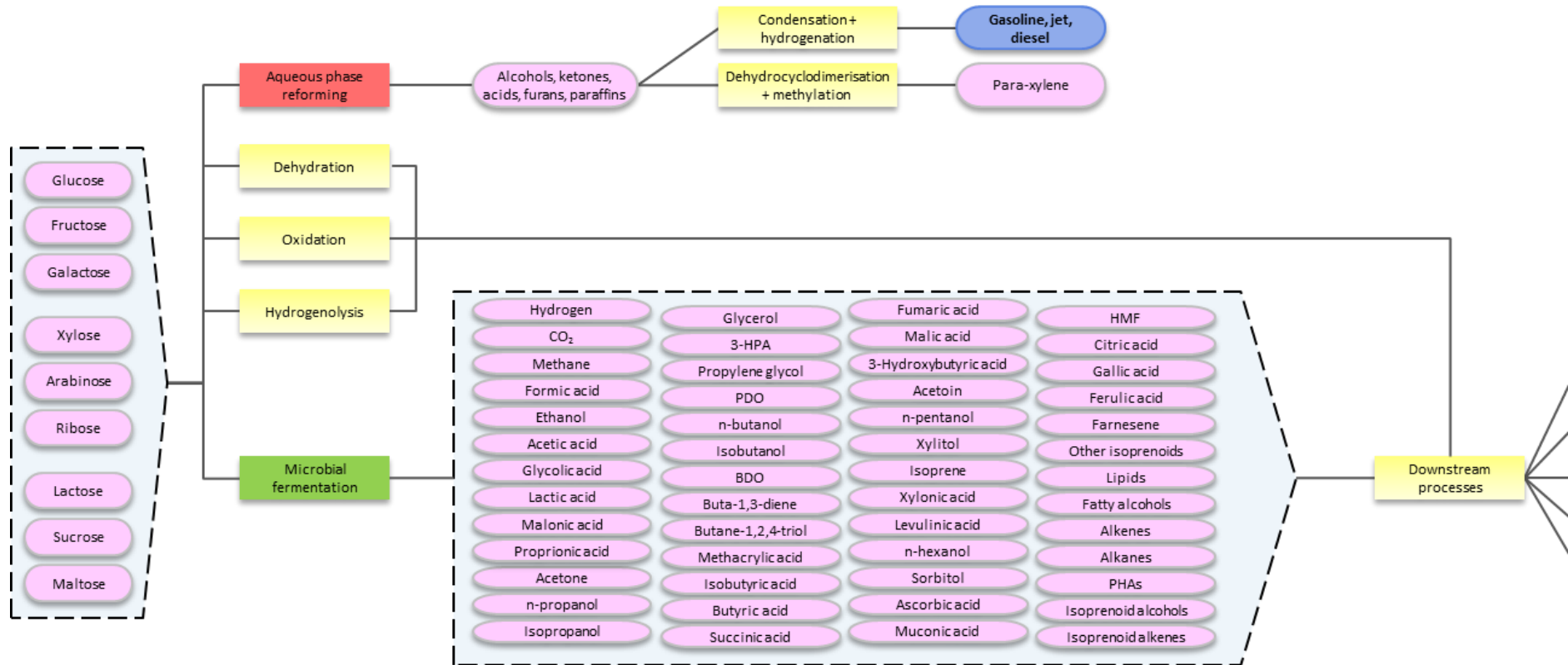

Figure 5: Downstream process options from sugars (the majority of which are fermentation based)

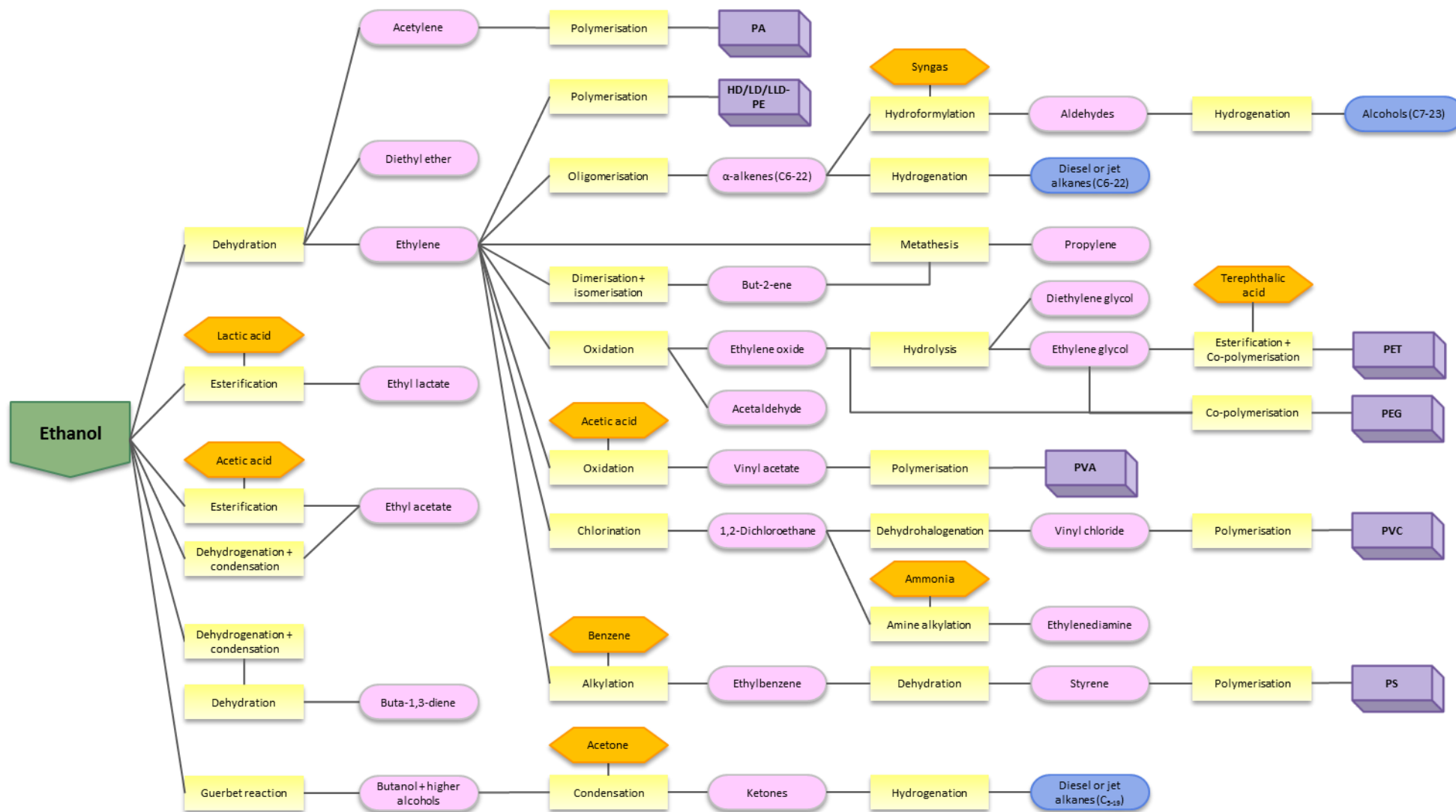

Figure 6: Downstream reactions for ethanol

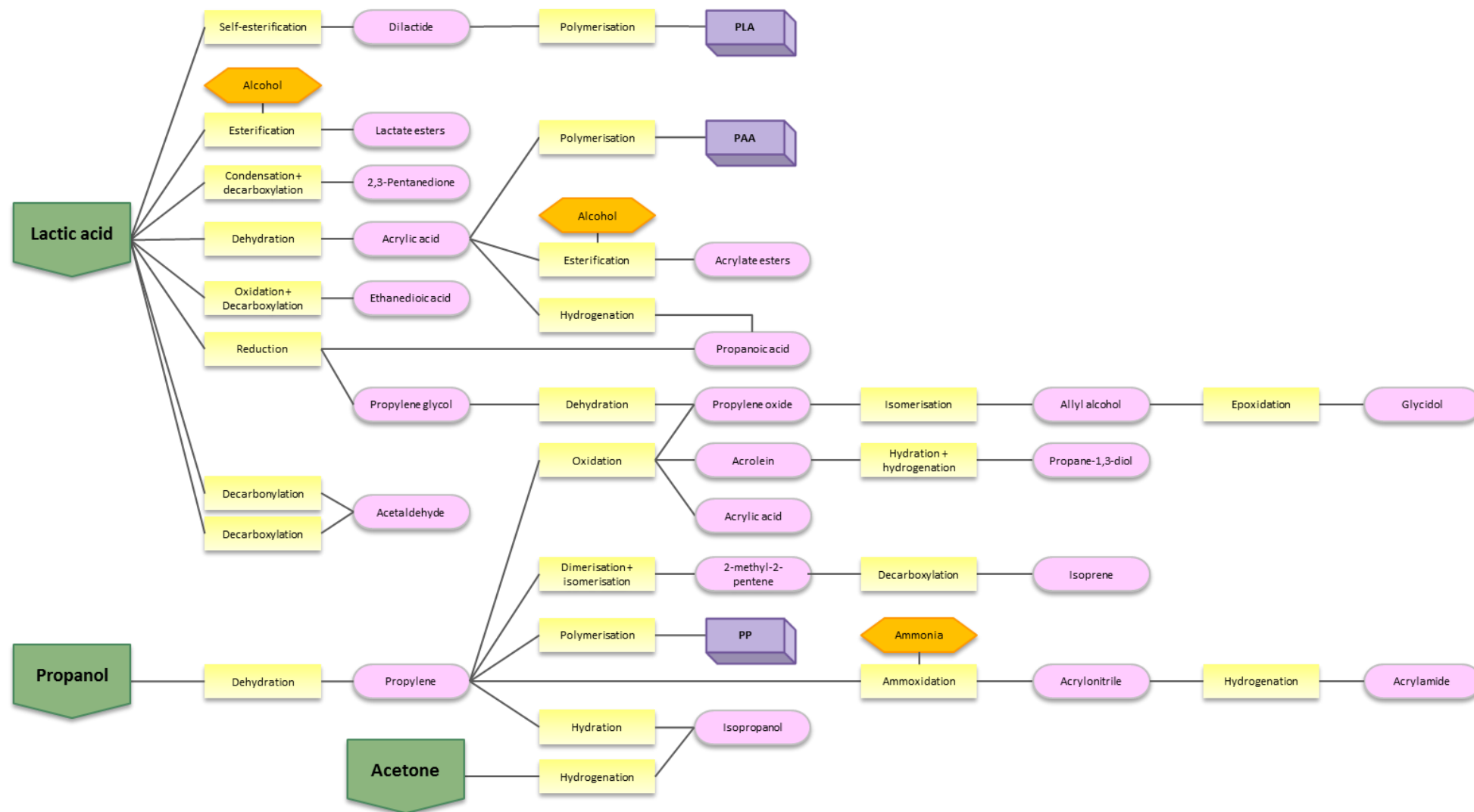

Figure 7: Downstream reactions for C3 intermediate products

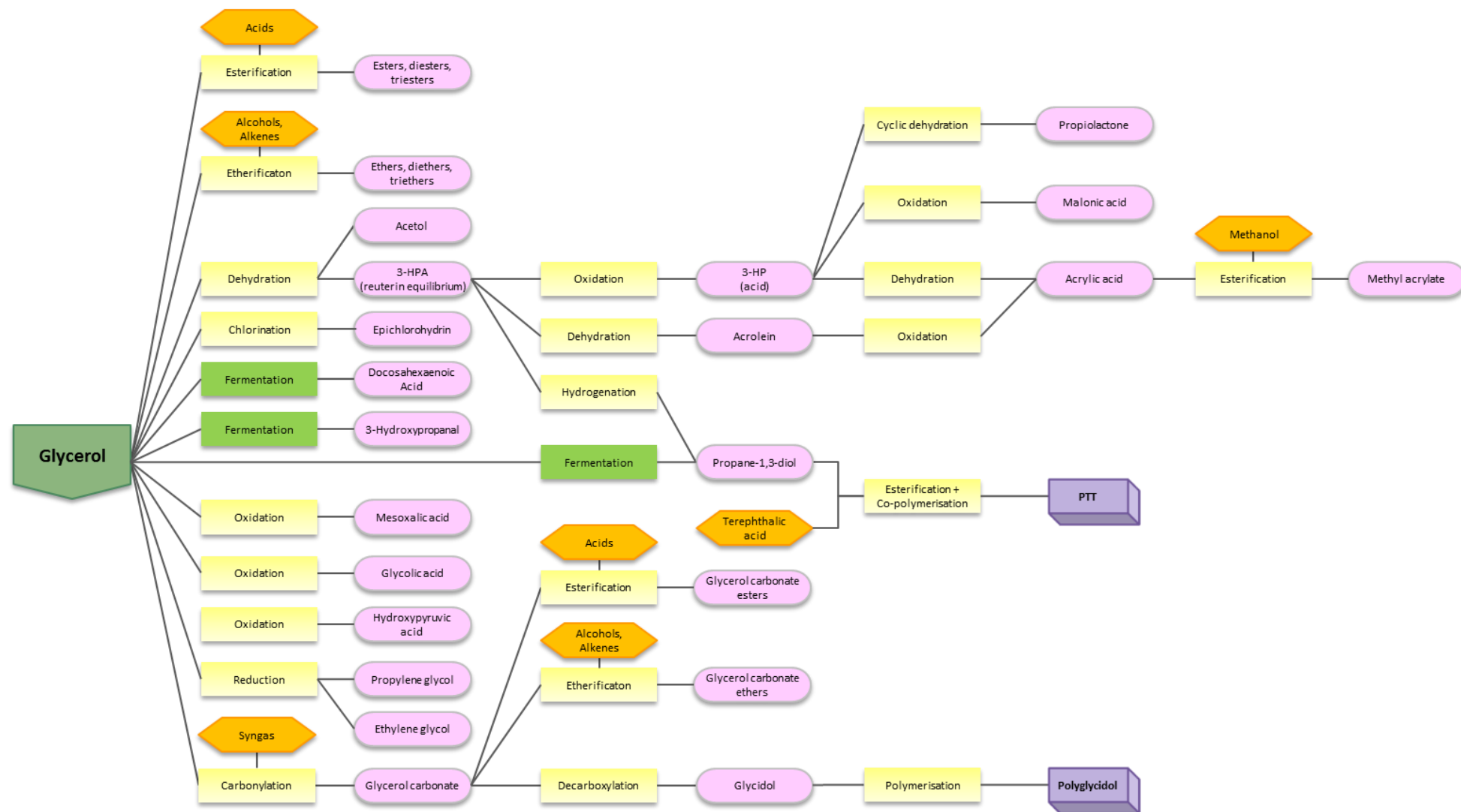

Figure 8: Glycerol downstream reactions

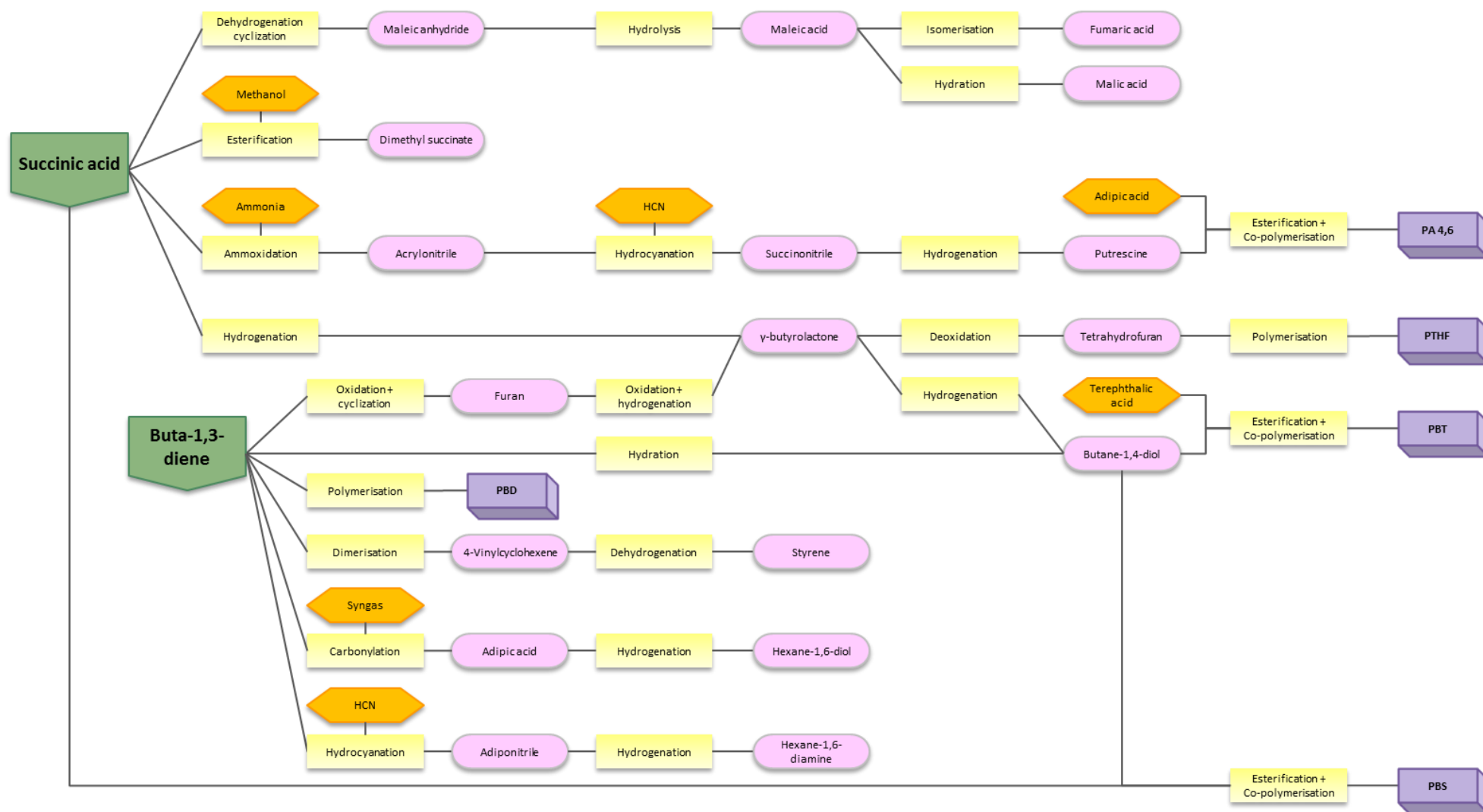

Figure 9: Downstream reactions for C4 intermediate products

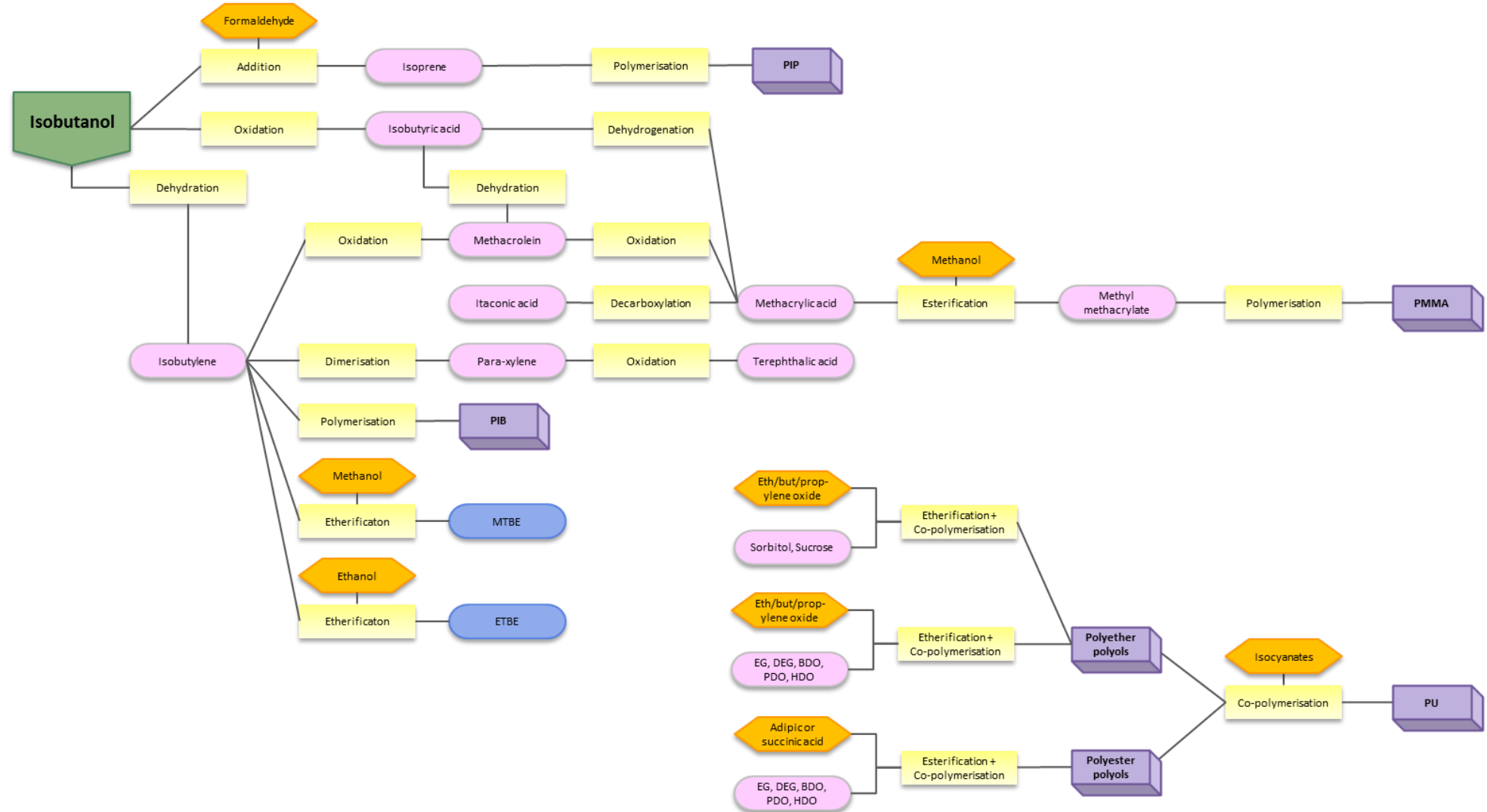

Figure 10: Isobutanol downstream reactions (top and left), and options for polyurethane synthesis (bottom right)

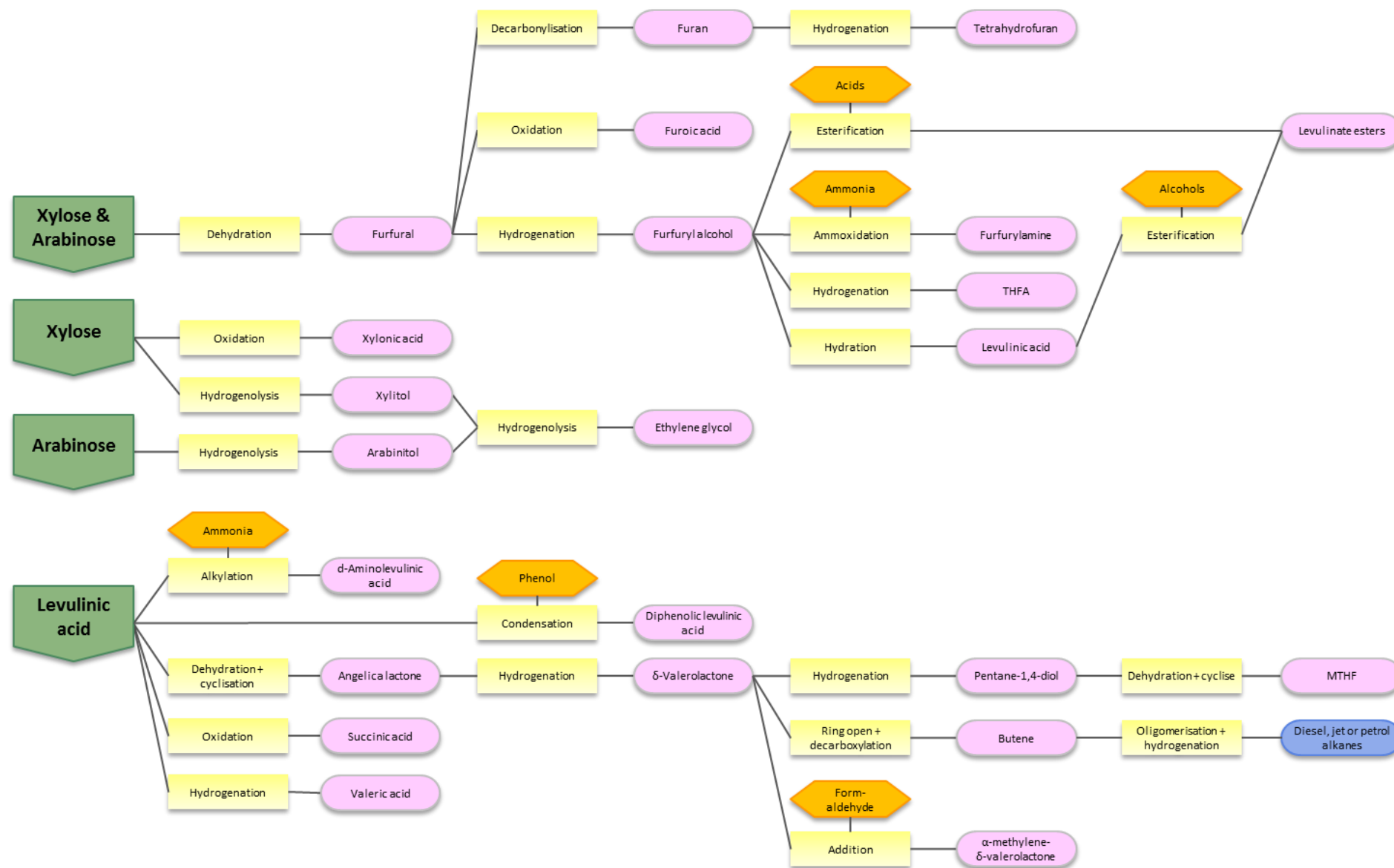

Figure 11: Downstream reactions for C5 sugars (top) and levulinic acid (bottom)

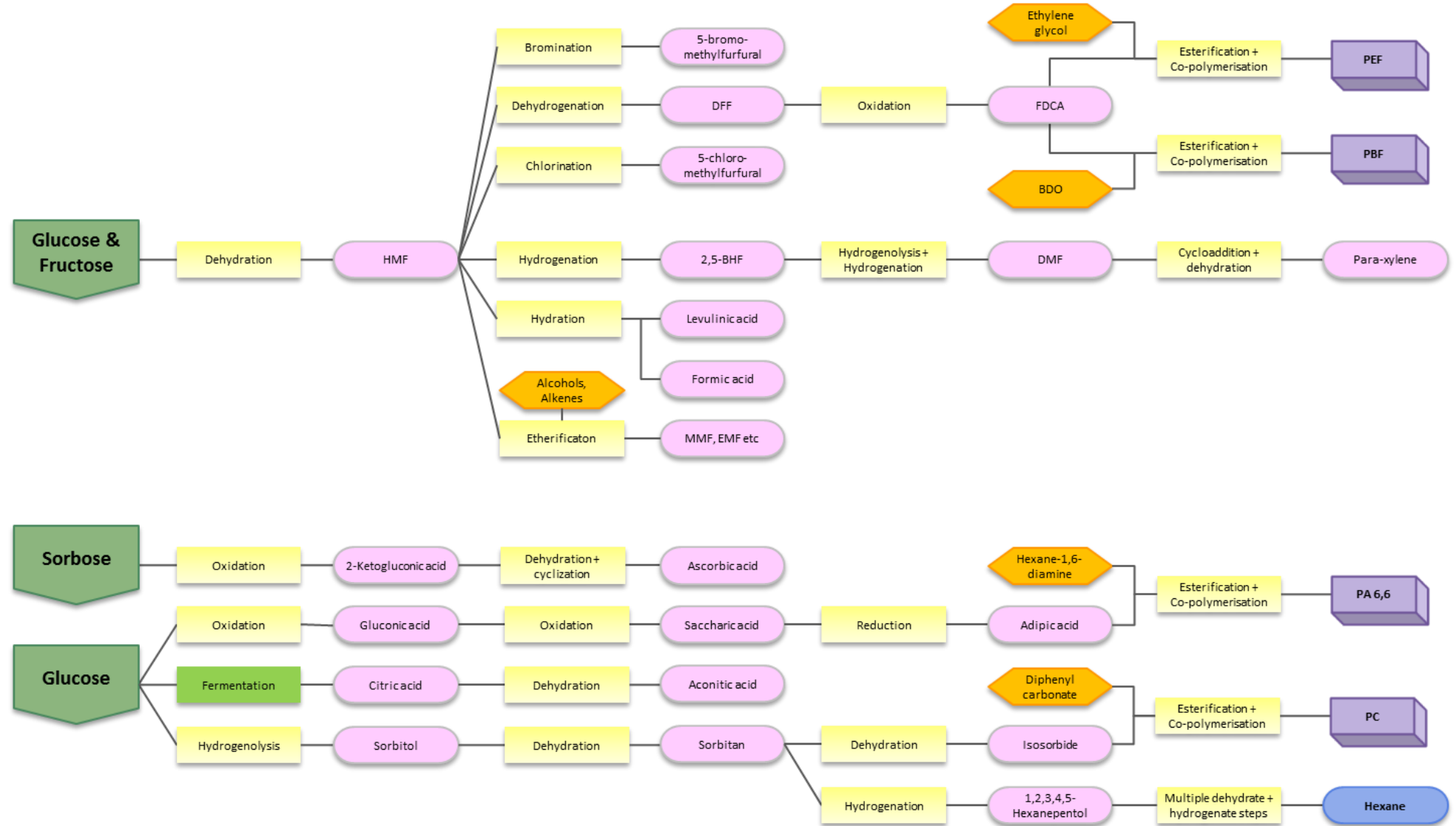

Figure 12: C6 sugars downstream reactions

Figure 6 demonstrates the importance of ethylene in the biochemicals and biopolymers industry, given that six major polymer classes can be derived from ethylene (PE, PET, PEG, PVA, PVC, PS). There is also flexibility to convert ethanol or ethylene to longer chains for application in the biofuels space.

Propylene in Figure 7 is also an important intermediate (particularly for PP), as is lactic acid (for PLA) – although it is possible to start further to the right of this diagram with propylene glycol, PDO or isoprene.

Although a co-product of the biodiesel and oleochemical industries, glycerol can be produced via sugar fermentation – and as shown in Figure 8, it has a wealth of downstream chains available. One important route to highlight is that acrylic acid can be made via 3-HPA.

Figure 9 justifies the recent industry interest in succinic acid, given its use in PBS, and possibilities to convert to BDO (for PBT and PBS) and a range of other acids, THF and amine compounds. Buta-1,3-diene also shows flexibility in producing furan, adipic acid and styrene.

Isobutanol is a starting point for the important intermediates of isobutylene (for para-xylene, PIB and fuel additives) and methacrylic acid (for PMMA). Figure 10 also shows at the bottom right the various options for producing polyurethanes (PU).

Starting with C5 sugars in Figure 11 allows production of furfural, and then furfuryl alcohol to produce levulinic acid, or furan for THF. Levulinic acid as a starting “feedstock” has several downstream products via δ -Valerolactone.

The top of Figure 12 shows the possible uses for 5-HMF, to produce para-xylene and FDCA (which can also be directly produced as a monomer for PEF and PBF). Glucose can also be converted to adipic acid (an important monomer for nylons), and sortibol (leading to isosorbide and polycarbonates).

3. Assessment of technology development status

Now that the various pathway maps have been established, this Chapter examines the development status of these technologies and recent progress by the actors involved. A key metric used throughout this Chapter is the TRL (Technology Readiness Level).

TRL is a relative measure, first introduced by NASA, of the maturity of evolving technologies on a scale of 1 to 9. TRL 1 corresponds to basic research on a new invention or concept, TRL 5 to pilot scale testing, whilst TRL 9 corresponds to mass deployment of a fully commercialised technology. The definitions of each TRL are given in Table 3, as given by Horizon 2020. Within this study, the TRL values of the relevant technologies at their current stage of development have been assessed.

Table 3: TRL definitions⁴

TRL	Plant stage	Definition
1	Basic research	Principles postulated and observed but no experimental proof available
2	Technology formulation	Concept and application have been formulated
3	Applied research	First laboratory tests completed; proof of concept
4	Small scale prototype	Built in a laboratory environment ("ugly" prototype)
5	Large scale prototype	Tested in intended environment
6	Prototype system	Tested in intended environment close to expected performance
7	Demonstration system	Operating in operational environment at pre-commercial scale
8	First of a kind commercial system	Manufacturing issues solved
9	Full commercial application	Technology available for consumers

We note that TRL definitions are not necessarily set by plant capacity, because some markets are orders of magnitude larger than others – and hence what might be a small demonstration plant in one market could count as a first commercial plant in another. The ktpa of product that a company manufactures is therefore only a guide to the level of commercialisation.

Based on the available literature, interviews with experts and the agreed study scope, we have developed a database of biochemical and biofuels companies. This database gives:

- the company name
- country of registration/headquarters
- the product manufactured
- the process technology used
- TRL
- current total production capacity of that product by the company (thousand tonnes per year)

⁴ http://ec.europa.eu/research/conferences/2013/energy_infoday/pdf/session_3_summary_of_the_calls_open_in_2014_-_philippe_schild.pdf

- location and type of activities (EU/North America/South America/Asia/Other for their R&D/pilot/demo/commercial/planned plants)
- further information, news and updates
- list of references used.

There is a separate row for each product made by each company, so that the database can be filtered by a specific product to assess all the main producers and their status. The key references used in deriving this database were Nova Institute (2012), Weastra (2013), Nexant (2014), de Guzman (2013), Kretschmer et al. (2013), BioREF-iNTEG (2010), Jogdand (2014), Harmsen & Hackmann (2013), de Jong et al. (2012 & 2014), plus numerous other online sources such as company press releases. Only the 94 products in scope have been considered in this TRL assessment. This database is not a fully comprehensive record of every production facility worldwide (as it only covers some of the more visible actors in China and India due to data constraints), but does cover all the main EU and US actors in the sector.

An analysis of the database gives the following results in Table 4 for the number of companies working on each product, the maximum TRL currently achieved, where any manufacturing (M), demonstration (D) or research/pilot (R) facilities are located globally, and a list of the most advanced developers. The table has been ordered by maximum TRL, instead of alphabetically.

The most advanced developers are classified as those being within 1 TRL of the maximum TRL for that product. The location of the facilities only shows the most advanced plant type in a region for each product – e.g. if an isobutanol organisation has both R&D and manufacturing facilities in the USA, for brevity, only the “M” for manufacturing facilities are shown in the next table under N Am (North America). The underlying database contains the non-abridged data. Where “>5” is shown for the TRL, this indicates that industrial actors are planning the construction of a large-scale facility (effectively skipping the demonstration stage), but until realised, the product therefore remains “pre-commercial” having only been validated at lab or pilot level.

Table 4 has some strong identifiable trends. The highest TRL products have a very strong manufacturing presence in Asia (mainly China), whereas most of the R&D and pilot plants are located in Europe and North America. South America has low activity in R&D, piloting and demonstration, although does have a couple of early commercial projects (plus a large number of planned projects in the pipeline). North America has the highest number of demonstration facilities, a similarly long list of products in R&D compared to Europe.

Table 4: Status and industrial activity for each product (ordered by TRL)

Product	Max TRL	# firms	Production facilities				Leading actors (within 1 TRL of max)
			EU	N Am	S Am	Asia	
Ethyl acetate	8-9	7	M	D		M	Dhampur Alco-Chem, Jubilant Lifescience, Laxmi Organic Industries, Sekab , Somaiya, Songyuan Ji'an Biochemical
Sorbitol	8-9	2		M		M	ADM, Roquette
1,2 butanediol	8-9	1				M	Global Biochem
1,3 propanediol	8-9	3	R	M		M	DuPont Tate & Lyle BioProducts, Zhangjiagang Glory Biomaterial
2,3 butanediol	8-9	3				M	Global Biochem, Novapha , Zhangjiagang Glory Biomaterial
Acetic acid	8-9	5	M	D		M	Jubilant Lifescience, Sekab , Songyuan Ji'an Biochemical
Acetic anhydride	8-9	1				M	Jubilant Lifescience
Acetone	8-9	10	R	D		M	Cathay Industrial Biotech, Jiangsu Lianhai Biological Technology, Laihe Rockley Bio-Chemicals, Lianyungang Lianhua Chemicals, Shi Jinyan, Songyuan Ji'an Biochemical, Tongliao ZhongKe Tianyuan Starch Chemical Co
n-butanol	8-9	13	R	D		M	
Epichlorohydrin	8-9	5	M			M	Solvay, Spolchemie, Yang Nong Jiang Su
Ethylene glycol	8-9	6	R			M	Global Biochem, Greencol Taiwan Corporation, India Glycols, Novapha
Ethylene	8-9	3			M		Braskem
Furfural	8-9	2	D	M			Central Romana Corporation
Furfuryl alcohol	8-9	2	M			M	TransFuran Chemicals, Zibo Shuangyu Chemical
Glutamic acid	8-9	4				M	Fufeng, Juhua, Meihua, Vedan
Itaconic acid	8-9	5		R		M	Alpha Chemika, Jinan Huaming Biochemistry, Qingdao Kehai Biochemistry Co, Zhejiang Guoguang Biochemistry
Lactic acid	8-9	11	M	M	M	M	Chongqing Bofei Biochemical Products, Corbion Purac, Galactic, Henan Jindan, HiSun, Wuhan Sanjiang Space Gude Biotech
Lactide	8-9	1	D			M	Corbion Purac
Lysine	8-9	2		M		M	BBCA, Evonik
PEG	8-9	1		M			DuPont
Propylene glycol	8-9	7	M	M		M	ADM, Global Biochem, Novapha , Oleon
PTT	8-9	2		M		M	DuPont, Zhangjiagang Glory Biomaterial
Squalene	8-9	1	M				Amyris
Terpenes	8-9	1		M			Allylix
Xylitol	8-9	3	M	R		M	DuPont Danisco, Roquette
Acetaldehyde	8-9	1	M				Sekab
EPDM	8	1			M		Lanxess
Iso-butanol	8	2	R	M			Butamax, Gevo
ETBE	8	1			M		Braskem
Fatty acids	8	2		M	M		Solazyme
PE	8	2			M		Braskem
PLA	8	4	D	M			Natureworks
Succinic acid	8	4	M	M			Myriant, Reverdia, Succinity, BioAmber
Isosorbide	7	3	D	R		D	Jinan Hongbaifeng Industry & Trade, Roquette
PBS	7	3				D	Anqing He Xing Chemical Corp
1,4 butanediol	7	5	R	D			BASF, Genomatica
Farnesene	7	1	R	R	D		Amyris
PHB	7	4	D		R	D	Biomer, Tianjin GreenBio Materials, Yikeman Shandong
Dimethyl isosorbide	6-7	1				D	Jinan Hongbaifeng Industry & Trade
Ethyl lactate	6-7	1		D			Vertec BioSolvents
Fatty alcohols	6-7	1		D			LS9
Furan	6-7	1		D			Pennakem
Levulinic acid	6-7	4	D	R		D	Segetis, Zibo Shuangyu Chemical
Methyl THF	6-7	1		D			Pennakem

From the Sugar Platform to biofuels and biochemicals

Product	Max TRL	# firms	Production facilities				Leading actors (within 1 TRL of max)
			EU	N Am	S Am	Asia	
PHBV	6-7	1				D	Zhejiang Tian An
Polyisobutene	6-7	1				D	Mitsubishi (MCC)
Butyric acid	>5	3	R	R			Metabolic Explorer
THF	>5	4	R				Davy Process Technology, Pennakem
Isoprene	>5	5	R	R		R	Amyris, DuPont, Glycos Biotechnologies
PHA	>5	4	R			R	Bio-on, Kaneka Crop, Metabolix
PP	>5	1					Braskem
Propylene	>5	4	R			R	Braskem/Toyota Tsusho
PVC	>5	1					Braskem/Solvay
3-HPA	5	3		R			Cargill/Novozymes, OPX Bio, Perstorp
5-HMF	5	1	R				AVA Biochem
Acrylic acid	5	7	R	R			ADM, Arkema, BASF, OPX Bio
Adipic acid	5	5		R			BioAmber, DSM, Rennovia, Verdezyne
Benzene	5	1		R			Virent
Butadiene	5	2	R				Genomatica, Global Bioenergies
Diesel	5	1		R			Virent
FDCA	5	1	R				Avantium
Formic acid	5	1	R	R			Biofine Technology
Gasoline	5	1		R			Virent
Glucaric acid	5	2		R			Rennovia, Rivertop Renewables
Iso-butene	5	2	R				Global Bioenergies, Lanxess
Jet fuel	5	4		R			Gevo, Virent
Methacrylic acid	5	2	R				Evonik
MMA	5	2	R				Evonik
para-xylene	5	2		R			Gevo, Virent
PBS with PLA	5	1		R			Amberworks
PBT	5	2	R	R			Lanxess, Toray
PET	5	1				R	Toray
PIA	5	1		R			Itaconix
Terephthalic acid	5	2		R		R	Toray, Virent
Furoic acid	5	1		R			xF Technologies
Caprolactam	4	1	R				DSM
Dodecanedioic acid	4	1		R			Verdezyne
γ-butyrolactone	4	2	R	R			BioAmber, Metabolix
Malic acid	4	1	R				Novozymes
Furoate esters	4	1		R			xF Technologies
Iso-pentanol	4	1		R			Saffron Eagle Biofuels
Fumaric acid	3-4	1		R			Myriant
Glycolic acid	3-4	1	R				Metabolic Explorer
Iso-propanol	3-4	4	R	R		R	Genomatica , IFP/WUR, Mascoma, Mitsui Chemicals
Methyl levulinate	3-4	1	R				Avantium
Muconic acid	3-4	3		R			Amyris, Genomatica , Myriant
PMMA	3-4	1	R				Lucite International
Heptanone	3	1		R			BGT Biogasoline
HMDA	3	2		R			BioAmber, Rennovia
Hexane	3	1		R			BGT Biogasoline
PA 6,6	3	1		R			Rennovia
Diaminopentane	3	2	R			R	Toray
n-propanol	2	2	R		R		Braskem , Deinove

Of these 94 products, there are 25 products of particular interest selected for further analysis, given the level of industry activity, and as highlighted by US DOE’s “Top10” biochemicals and IEA Bioenergy Task 42 reports. These 25 are mostly primary products (made as a first step direct from sugars), as the processes to make the downstream products and polymers are generally not seen as the rate limiting step. In Figure 13 below we show the spread of TRL values achieved for each product, allowing a visible comparison of which products are nearest commercialisation. Chemical processes are shown in yellow, thermo-chemical processes in red, and biological processes in green (with intracellular production in brighter green compared to extracellular production in lighter green). Note that unless marked with “LC” for lignocellulosic, all the products are produced from sugar/starch crops.

Figure 13 clearly shows the “valley of death” between a large number of products at pilot or lab-scale (TRL 5 or lower), and another cluster of commercialised products (TRL 8-9). There are relatively few products currently making the transition through demonstration – the longer list of products in Table 4 indicates that only 14 of the 94 products in scope are currently at TRL 6 or 7.

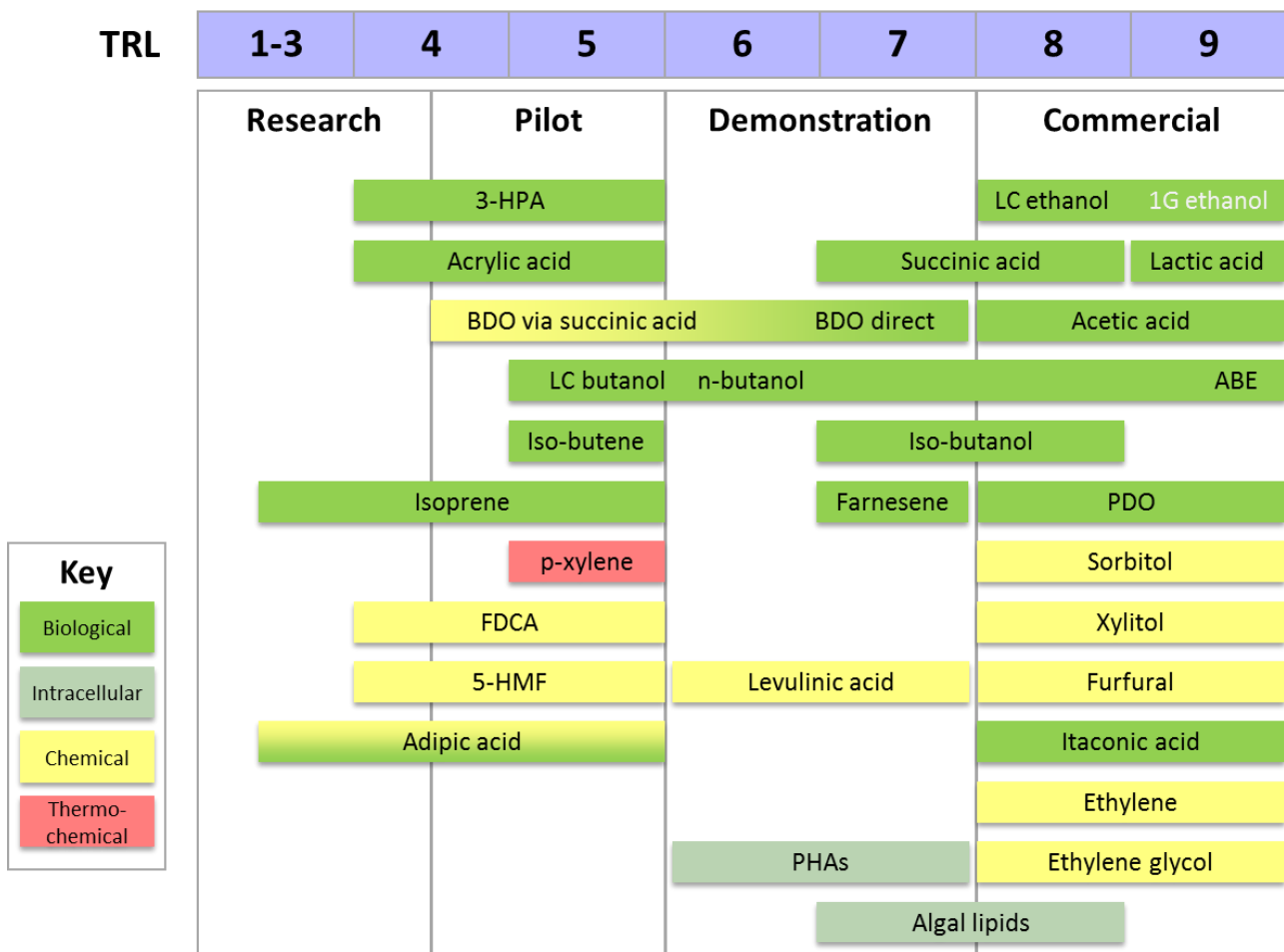

Figure 13: Commercialisation status of the 25 selected sugar platform products

Bio-based chemical building blocks can be divided into drop-in and novel bio-based chemicals. Drop-in chemicals are bio-based versions of existing petrochemical products. They are chemically equivalent to the incumbent fossil-based products, and therefore enable reduced risks and faster access to markets. Their market entry is mainly restricted by their cost competitiveness. Novel bio-based chemicals are not direct drop-in substitutes, and hence bear higher risks, but may offer unique product properties unattainable with fossil-based alternatives (e.g. biodegradability). Despite potentially superior product properties, the introduction of novel bio-based building blocks is challenging due to resistance to change from other industrial players in the value chain (Bio-TIC, 2014).

Whilst taking a new conversion technology from the lab, through piloting, then demonstration, before building a commercial plant, is the usual pathway for most bio-based products (particularly biological routes), this process can be accelerated by skipping steps (particularly true for drop-in products and chemical processes where the risks are often better understood). There is therefore not an industry accepted timeframe for how long it takes a biofuel, biochemical or biopolymer to reach commercialisation, as it depends heavily on economics (value proposition), drop-in vs. non drop-in (existing demand), conversion technology (biological, chemical, thermo-chemical), and partnerships (upstream and downstream supply chain integration).

Our research and stakeholder input suggests that it may take a technology developer **at least** 10 years to successfully progress from having an established pilot (TRL5), de-risking via a demonstration plant (TRL6-7), to reach commissioning of a first commercial plant (TRL8). This minimum timeframe applies in the regions where policy has been supportive (e.g. US LC ethanol), whereas slower development is seen in less supportive regions or with more cautious technology developers (smaller scale-up steps or repeating plants). Some routes may never be commercialised due to unattractive economics (e.g. sugars to glycerol).

4. Market size

For the biofuels and biochemicals defined in scope, this Chapter provides a short description of the product, and the uses it currently has (or could do in the future), and hence the fossil products that it displaces. We have also collected data on product prices and market volumes, and hence have estimated the potential value of each product market.

From the available literature and access to industry intelligence (i.e. Bloomberg), we have collected indicative prices, global production volumes and market sizes for each of the selected 25 primary products, along with their fossil counterparts (where applicable). This data has been supplemented by the cumulative production volumes from the database of companies (given in Section 3), as well as press releases and other market industry reports. Note that most of the source data is from 2013 or 2014, so does not reflect the dramatic drop (>50%) in crude oil prices experienced globally in the last six months: some of the fossil-derived comparators may now be significantly cheaper than listed below.

The prices given in Table 5 are in today's US dollars, and in some cases reflect a range of different regional prices (whereas in other cases, only one data source was available, or the global average price is given). The total market size and value presented in Table 5 does not include the potential substitution of other molecules (i.e. non-drop in replacements). These other markets are discussed within the case studies, for selected products.

Some of the established bio-based products already dominate global production (e.g. ethanol, PDO, lactic acid), and several products do not have an identical fossil-based substitute (e.g. xylitol, FDCA, farnesene). In terms of the largest markets, Table 5 shows that bio-ethanol dominates at \$58bn a year, followed by much smaller, but still significant, markets for n-butanol (current production mainly via the ABE process), acetic acid and lactic acid. Xylitol, sorbitol and furfural also show significant markets for chemical conversion of sugars, without petrochemical alternatives. The smallest bio-based markets are, as is to be expected, those of the earliest stage products, such as 3-HPA, acrylic acid, isoprene, adipic acid and 5-HMF. Bio-based FDCA, levulinic acid and farnesene have the highest current prices, but could be expected to drop to around \$1,000/tonne (the indicative future bio-based production cost being targeted by several companies^{5,6,7}) once the relevant conversion technologies have been successfully commercialised.

Bio-based succinic acid is the fastest growing market at present, due to the level and breadth of industry activity in the product. In many cases, **if economically competitive**, bio-based products could easily overtake their fossil based alternatives, and expand into new non drop-in markets – they are not necessarily limited by the current demand in the total (bio+fossil) drop-in replacement market. Many bio-based products will however be struggling to compete economically due to significantly lower crude oil prices in recent months – we discuss some of the potential impacts in Appendix D.

⁵ http://www.bioconcept.eu/wp-content/uploads/BioConSepT_Market-potential-for-selected-platform-chemicals_report1.pdf

⁶ <http://www.grandviewresearch.com/press-release/global-levulinic-acid-market>

⁷ <http://www.altenergystocks.com/archives/biomass/biochemicals/>

Table 5: Estimated prices and volumes for bio-based and total product markets

Product	Bio-based market				Total market (bio+fossil)		
	Price (\$/t)	Volume (ktpa)	Sales (m\$/y)	% of total market	Price (\$/t)	Volume (ktpa)	Sales (m\$/y)
Acetic acid	617	1,357	837	10%	617	13,570	8,373
Ethylene	1,300-2,000	200	260-400	0.2%	1,100-1,600	127,000	140,000-203,000
Ethylene glycol	1,300-1,500	425	553-638	1.5%	900-1,100	28,000	25,200-30,800
Ethanol	815	71,310	58,141	93%	823	76,677	63,141
3-HPA	1,100	0.04	0.04	assumed 100%	1,100	0.04	0.04
Acetone	1,400	174	244	3.2%	1,400	5,500	7,700
Acrylic acid	2,688	0.3	0.9	0.01%	2,469	5,210	12,863
Lactic acid	1,450	472	684	100%	1,450	472	684
PDO	1,760	128	225	100%	1,760	128	225
BDO	>3,000	3.0	9	0.1%	1,800-3,200	2,500	4,500-8,000
Isobutanol	1,721	105	181	21%	1,721	500	860
n-butanol	1,890	590	1,115	20%	1,250-1,550	3,000	3,750-4,650
Iso-butene	>>1,850	0.01	0.02	0.00006%	1,850	15,000	27,750
Succinic acid	2,940	38	111	49%	2,500	76	191
Furfural	1,000-1,450	300-700	300-1,015	assumed 100%	1,000-1,450	300-700	300-1,015
Isoprene	>2,000	0.02	0.04	0.002%	2,000	850	1,700
Itaconic acid	1,900	41	79	assumed 100%	1,900	41.4	79
Levulinic acid	6,500	3.0	20	assumed 100%	6,500	3.0	20
Xylitol	3,900	160	624	assumed 100%	3,900	160	624
FDCA	NA (high)	0.045	~10	assumed 100%	NA (high)	0.045	~10
5-HMF	>2,655	0.02	0.05	20%	2,655	0.1	0.27
Adipic acid	2,150	0.001	0.002	0.00003%	1,850-2,300	3,019	5,600-6,900
Sorbitol	650	164	107	assumed 100%	650	164	107
p-xylene	1,415	1.5	2.1	0.004%	1,350-1,450	35,925	48,500-52,100
Farnesene	5,581	12	68	assumed 100%	5,581	12.2	68
Algal lipids	>>1,000	122	>122	assumed 100%	>>1,000	122	>122
PHAs	6,500	17	111	assumed 100%	6,500	17	111

5. Case studies

5.1. Selection criteria

A total of 10 products were selected as detailed case studies for this report, down-selected from the previous list of 25. The case studies are acrylic acid, adipic acid, 1,4-butanediol (BDO), farnesene, 2,5-Furandicarboxylic acid (FDCA), iso-butene, polyhydroxyalkanoates (PHAs), polyethylene (PE), polylactic acid (PLA) and succinic acid. The down-selection was based on a number of criteria:

- The technologies involved are at least TRL 5 today, so that the pathway has potential commercial relevance within the next 10 years.
- An active market place reporting a number of market players already involved in the pathway.
- Involvement of at least one EU actor in developing technology along the pathway. The selected pathways selected were focussed on EU success stories where possible.
- Notable potential market size, including economic value and/or GHG emissions savings. Cases were considered where either existing demand is significant and the product is a drop-in, or the market for a non-drop-in product is growing very fast.
- Selected products begin at biomass feedstocks (either food crops or lignocellulosic material), and end at a final material (fuel, chemical or polymer). Case studies were selected to analyse a whole pathway, rather than terminating at intermediate products with significant downstream uses.

Each case study is a detailed review of the bio-based product, the actors involved in its production, the value proposition, and the expected market outlook. Each case study is structured as follows:

- A brief product description, including its applications and competing fossil products. A supply chain overview, which highlights the technologies and pathways involved, plus any competing routes.
- A market analysis which describes the current market volumes and prices. Particular applications or regions of dominance are also examined.
- An activity summary of companies/actors involved in the bio-based product. This is divided into European actors and those in the rest of the world. Each actor is briefly examined to establish manufacturing location, status (pilot/demo/commercial), and application focus. Any partnerships, joint ventures or noteworthy customers are also highlighted.
- The value proposition of the bio-based product, as defined by the production costs (current or expected), the greenhouse gas (GHG) emissions, and the physical properties of the product, especially in comparison to the fossil-based product(s) it may compete against. Trade-offs, particularly cost versus environmental credentials, are also highlighted.
- The product prospects and outlook over the next few years. This includes the expected market growth rates and prices (especially against fossil competitors), plans in place to expand/commercialise, and also highlights what markets/applications may be expected to develop. Finally, any key drivers or plays necessary to unlock the market potential are briefly discussed together with potential limitations.

The case studies were compiled following an extensive review of publically available information. In order to ensure an accurate and up-to-date reflection of the status and market for each product, drafts of the case studies were distributed to key industry contacts for review (not all case studies externally reviewed).

5.2. Acrylic acid

Descriptions and markets

Acrylic acid is an organic acid with 3 carbon atoms, systematically named prop-2-enoic acid. It is a clear, colourless, corrosive liquid with a characteristic acid or tart smell. Acrylic acid and its esters readily combine with themselves (to form e.g. polyacrylic acid) or other monomers (e.g. acrylamides, acrylonitrile, vinyl, styrene, and butadiene) by reacting at their double bond, forming homopolymers or copolymers which are used in the manufacture of various plastics, coatings, adhesives, diapers, fibres and textiles, resins, detergents and cleaners, elastomers (synthetic rubbers), as well as floor polishes, and paints. Acrylic acid is used to improve hardness, tackiness and durability. It is also widely used as a chemical intermediate in multiple industrial processes.

Conventional petrochemical acrylic acid is produced via the oxidation of propylene, which is typically created by the cracking of naphtha. Major producers are BASF, Dow Chemical, Arkema, Nippon Shokubai, Jiansu Jurong Chemical, LG Chemical, Mitsubishi Chem, and Shanghai Huayi.

Bio-based acrylic acid is produced through the dehydration of 3-hydroxypropionic acid (3-HPA), which is derived via fermentation of sugar to 3-HPA. Processes have also been developed to produce 3-HPA from glycerol (either via dehydration to acrolein followed by oxidation or in a single step oxydehydration)⁸. Alternatively, sugar-derived lactic acid can be dehydrated to form acrylic acid. These bio-based processes are shown in Figure 14 below, although none are yet commercially available.

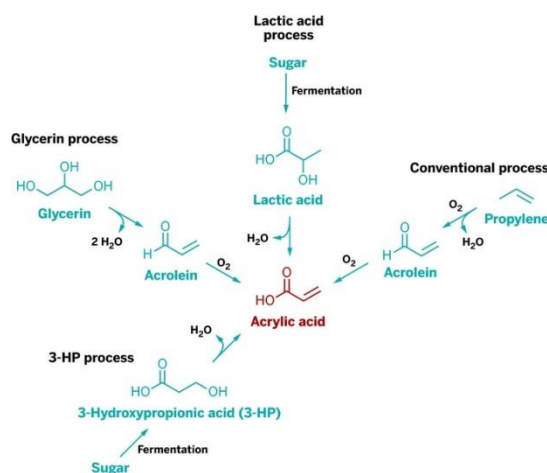

Figure 14: Production pathways for bio-based acrylic acid⁹

In 2006, the production of acrylic acid was 3.3 million tonnes¹⁰, whereas in 2013, production totalled around 5 million tonnes¹¹, with an estimated market value of over \$11 billion¹². The majority of acrylic acid (so-called crude acrylic acid) is used to make acrylate esters, followed by the use of acrylic acid (glacial acrylic acid) for the production of polyacrylic acid, used mostly in superabsorbent polymers¹³. The market price for acrylic acid in 2013 was approximately 2,500 \$/tonne. The annual production volume for bio-based acrylic acid, still in pilot phase, is only around 300 tonnes.

⁸ <http://www.ieabioenergy.com/wp-content/uploads/2013/10/Task-42-Biobased-Chemicals-value-added-products-from-biorefineries.pdf>

⁹ <http://cen.acs.org/articles/91/i46/Hunting-Biobased-Acrylic-Acid.html?h=1016647717>

¹⁰ <http://www.ieabioenergy.com/wp-content/uploads/2013/10/Task-42-Biobased-Chemicals-value-added-products-from-biorefineries.pdf>

¹¹ <http://cen.acs.org/articles/91/i46/Hunting-Biobased-Acrylic-Acid.html?h=1016647717>

¹² <http://www.alliedmarketresearch.com/acrylic-acid-market>

¹³ <http://cen.acs.org/articles/91/i46/Hunting-Biobased-Acrylic-Acid.html?h=1016647717>

Actors

The development of bio-based acrylic acid production has seen the formation of two key strategic partnerships, namely BASF/Cargill/Novozymes and OPXBio/Dow. These relationships have so far proved worthwhile (at pilot scale), and with each bringing unique expertise to the partnerships should provide a solid foundation for commercialisation of bio-based acrylic acid and its downstream applications. The overview of actors below covers only bio-based acrylic acid activity.

Europe

- **BASF/Cargill/Novozymes:** Joint research effort aiming to commercialise production of bio-acrylic acid via a 3-HP process. They have demonstrated the production of 3-HP at pilot scale, and have also successfully converted 3-HP to glacial acrylic acid and superabsorbent polymers. They are aiming to setup an integrated pilot plant, with 80,000L fermentation vessels, by the end of 2014.
- **Arkema:** Currently producing fossil acrylic acid. In 2010 they built a pilot plant in Carling, France (producing a few kg per day) to convert bio-based glycerol to acrylic acid, with the backing of the F3Factory European project and local support. The process was developed to full-scale manufacturing readiness, but put on hold as the high cost of glycerol made the product uncompetitive with petro-based acrylic acid. Note this route is not via the sugar platform.

Rest of the world

- **OPXBio/Dow:** Have developed a process using fermentation of sugar to 3-HP followed by dehydration to make acrylic acid. They are working jointly with Dow Chemical to develop an industrial scale process that produces a direct replacement option for petro-acrylic acid. They currently have a pilot-scale plant (3,000L fermentation vessels, ~27 tpa) and are planning to scale-up to 50,000L vessels within the next year. Commercial production of around 50 kilotonnes per year is expected to commence in 2017.
- **Metabolix:** Developing a process ("FAST") to use a polymer as an intermediate for acrylic acid. Microbes are engineered to express poly(3-hydroxypropionate), or P3HP, which is then dried to produce solid biomass. Once the biomass is heated (thermolysis), P3HP vaporises into acrylic acid. They have demonstrated the process and provided samples for testing.
- **Myriant:** Developing a process to produce bio-acrylic acid via sugar-derived lactic acid. They currently have a patent for this process, and are looking to advance to pilot scale production in the next year.
- **SGA Polymers:** A spin-off of MATRIC (contract R&D), SGA has developed a process to produce bio-acrylic acid from sugar-derived lactic acid. A patent has been filed, and the technology demonstrated at lab scale. They are currently seeking funding.
- **Novomer:** A novel process which aims to capture waste carbon dioxide (from industrial gas production), convert it to carbon monoxide (CO) using a solid oxide electrolysis process, and use a catalyst-based process to convert the CO and ethylene oxide (from shale gas) into acrylic acid. Using a US \$5million grant from the US Department of Energy, they aim to reach pilot scale (2 ktpa) in 2015 and commercial scale in 2017¹⁴.
- **Genomatica:** Have filed a patent from a process to produce bio-based acrylic acid via fumaric acid.

¹⁴ http://novomer.com/?action=pressrelease&article_id=60

An interesting point to note is the level of fragmentation amongst technology developers. This has developed as a result of the various routes to produce bio-acrylic acid, each with different feedstocks. Players such as Cargill/BASF/Novozymes, OPXBio/Dow, and Metabolix are focusing on the 3-HPA process, Arkema on the glycerol route, and Myriant and SGA Polymers on lactic acid. More important than the yields is often the product's competitiveness with existing commercial technologies¹⁵, and the various process and feedstock combinations selected by each actor may determine which is able to successfully compete with petro-based acrylic acid.

Value proposition

There are both financial and environmental benefits to replacing petro-based acrylic acid with a bio-based equivalent. The current production cost of fossil acrylic acid is geographically dependent, ranging from 1,600 \$/ tonne in Asia to 1,900 \$/tonne in Europe and 2,200 \$/tonne in the USA. Bio-based acrylic acid producer OPXBio has claimed initial production costs of 838 - 1,102 \$/tonne¹⁶. Metabolix believe their bio-based process to be cost competitive with petro-acrylic acid at an oil price of 90 \$/per barrel¹⁷. Propylene feedstock cost is the largest single component (48-55%) of acrylic acid production cost, primarily due to the cost of the crude oil derivatives (naphtha or vacuum gas) required^{18,19}. Bio-based processes may benefit from production costs 20 - 48% better than the petro-based acrylic acid process²⁰. Drawbacks of the bio-based process include high investment costs.

GHG savings for bio-acrylic acid versus petro-acrylic acid are approximately 1.5 tCO₂/ t-product, which could result in overall annual GHG savings (based on complete replacement) of up to 4.4 million tonnes CO₂/year²¹. OPXBio's production process has been estimated to reduce GHG emissions by over 70% compared to petro-acrylic acid production²². Similarly, Novomer expects an increase in energy productivity of 30-70% during processing as their catalysts operate between 30-50 °C, compared to the 250°C of petro-acrylic acid processing²³.

Outlook

The global acrylic acid market is projected to increase at a CAGR of 7.6% from 2014 to 2020, reaching demand of around 7.4 million tonnes annually by 2020²⁴. The increased demand for acrylic acid is due in part to a projected increase in diaper use in developing economies, which is set to increase the demand for superabsorbent polymers by 4-5% globally. Moving away from the use of PVA and vinyl acetate to acrylic emulsions will also increase acrylic acid demand²⁵. Looking at the segmentation of use, it is projected that acrylic esters will continue to dominate, producing the highest revenue per segment, while acrylic polymers are forecast to be the fastest growing segment to 2020²⁶.

¹⁵ <http://www.nexant.com/blog/bio-based-acrylic-acid-considerations-commercial-viability-and-success>

¹⁶ <http://greenchemicalsblog.com/2012/09/01/5060/>

¹⁷ <http://www.metabolix.com/Products/Biobased-Chemicals/Chemical-Products/Bio-Based-Acrylic-Acid>

¹⁸ http://www.ihs.com/pdfs/RP6E_toc.pdf

¹⁹ <http://www.propylene-propane-markets-2014.com/media/downloads/15-day-two-mathew-george-head-of-exports-indian-oil.pdf>

²⁰ <http://www.propylene-propane-markets-2014.com/media/downloads/15-day-two-mathew-george-head-of-exports-indian-oil.pdf>

²¹ <http://www.ieabioenergy.com/wp-content/uploads/2013/10/Task-42-Biobased-Chemicals-value-added-products-from-biorefineries.pdf>

²² <http://www.businesswire.com/news/dow/20110411005906/en>

²³ <http://greenchemicalsblog.com/2013/09/24/novomer-to-produce-co2-based-acrylic-acid/>

²⁴ https://www.academia.edu/7827383/Global_Acrylic_Acid_Market

²⁵ <http://www.propylene-propane-markets-2014.com/media/downloads/15-day-two-mathew-george-head-of-exports-indian-oil.pdf>

²⁶ https://www.academia.edu/7827383/Global_Acrylic_Acid_Market

The role of bio-based acrylic acid in this growth is also set to increase. This is due not only to demand for reductions in GHG emissions and (potentially) better profit margins, but also by incentive to reduce reliance on crude oil and the associated price volatility^{27,28}. Further, the introduction of low-cost ethane extracted from shale deposits has seen a shift in the use of petro-based feedstocks to natural gas-based feedstocks. Natural gas cracking produces less propylene co-product, decreasing the volumes of propylene available to the market and increasing pressure on propylene and petro-acrylic acid prices. However, this may change if planned facilities in the USA to dehydrogenate propane, increasingly found in shale gas, into propylene come online²⁹. A switch to bio-based acrylic acid would serve to decouple economic dependence on propylene, but may have implications on dependence on alternative feedstocks, such as sugar, glycerol and lactic acid³⁰.

The role of government regulation, especially in relation to environmental concerns and occupational exposure, may also serve as a driver in the shift to a bio-based acrylic acid alternative. However, caution is required, since in the past, policy changes which affected biofuels production led to decreases in availability and increases in the price of glycerol, which negatively impacted the economics of bio-acrylic acid projects such as Arkema and Nippon Shokubai^{31,32}.

There are a number of highly ambitious plans to commercialise technologies, already proved at pilot scale, as soon as 2017. The industry has also seen increasing collaboration between major players in order to exploit industry knowledge and fast-track commercial development via a number of different processes and feedstocks. This diversity will undoubtedly prove successful for some and not for others, as market volatility affects each differently. Nevertheless this fragmentation, coupled with increased market pull and cost competitiveness at sufficiently high oil prices, should see a shift away from petro-based acrylic acid towards a bio-based equivalent.

²⁷ <http://www.metabolix.com/Products/Biobased-Chemicals/Chemical-Products/Bio-Based-Acrylic-Acid>

²⁸ https://www.academia.edu/7827383/Global_Acrylic_Acid_Market

²⁹ <http://cen.acs.org/articles/91/i46/Hunting-Biobased-Acrylic-Acid.html?h=1016647717>

³⁰ <http://www.nexant.com/blog/bio-based-acrylic-acid-considerations-commercial-viability-and-success>

³¹ <http://www.arkema.com/en/innovation/responses-to-global-trends/renewable-raw-materials/biorefining/>

³² <http://www.nexant.com/blog/bio-based-acrylic-acid-considerations-commercial-viability-and-success>

5.3. Adipic acid

Descriptions and markets

Adipic acid (ADA) is a C6 straight-chain dicarboxylic acid used as monomer for the production of nylon and polyurethane. Around 85-90%^{33,34} of adipic acid is used in the production of nylon 6-6³⁵, a high performance engineering resin, or is further processed into fibres (polyurethanes, adipic esters) for applications in carpeting, automobile tyre cord, and clothing. Adipic acid is also used to manufacture plasticizers and lubricant components. Food grade adipic acid is used as a gelling aid, an acidulant, and as a leavening and buffering agent.

Conventional adipic acid is currently produced from various petrochemical feedstocks such as cyclohexane (93% of global production capacity)³⁶, benzene or phenol³⁷ in a two-step process³⁸. Cyclohexane is oxidized to produce KA oil (cyclohexanone and cyclohexanol), followed by nitric acid oxidation of KA oil to produce adipic acid. Routes using phenol have been mainly eliminated due to its toxic nature.

Bio-based production of adipic acid is possible via chemical conversion of benzene (involving catalysts), or fermentation (direct from sugars, or from muconic or glucaric acid)³⁹. An example of a fermentation bio-based process is the use of lignocellulosic sugars, obtained from the Proesa® process⁴⁰ which is able to convert lignocellulosic biomass into fermentable sugars⁴¹. The sugars are then converted to adipic acid after fermentation and hydrogenation steps. A process using genetically modified micro-organisms to ferment glucose directly to adipic acid has also been developed by Verdezyne^{42,43}. For example *E. coli* bacteria sequentially ferment glucose to 3-dehydroxyshikimate, then to cis, cis muconic acid⁴⁴. The final hydrogenation step to adipic acid takes place at elevated pressure. There are also two-step chemo-catalytic routes (Figure 16) whereby glucose is anaerobically oxidized to form glucaric acid, then converted into adipic acid via hydrodeoxygenation^{45,46}.



Figure 15: Adipic acid production from LC biomass

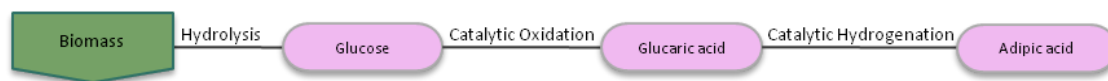

Figure 16: Adipic acid catalytic production

³³ <https://www.thechemco.com/chemical/adipic-acid/>

³⁴ <http://www.ihs.com/products/chemical/technology/pep/bio-based-adipic-acid.aspx>

³⁵ <http://www.transparencymarketresearch.com/synthetic-and-bio-based-adipic-acid.html>

³⁶ <http://www.ihs.com/products/chemical/technology/pep/bio-based-adipic-acid.aspx>

³⁷ <http://www.groenegrondstoffen.nl/downloads/Boekjes/16GreenBuildingblocks.pdf>

³⁸ <http://www.ihs.com/products/chemical/technology/pep/bio-based-adipic-acid.aspx>

³⁹ <http://greenchemicalsblog.com/2013/10/02/rennovia-produces-100-bio-based-nylon/>

⁴⁰ <http://www.chemicals-technology.com/projects/verdezyne-adipic-acid-plant-california/>

⁴¹ <http://www.biochemtex.com/proesa>

⁴² <http://www.chemicals-technology.com/projects/verdezyne-adipic-acid-plant-california/>

⁴³ <http://greenchemicalsblog.com/2013/10/02/rennovia-produces-100-bio-based-nylon/>

⁴⁴ http://en.european-bioplastics.org/wp-content/uploads/2011/03/publications/PROBIP2009_Final_June_2009.pdf

⁴⁵ <http://www.icis.com/resources/news/2010/09/27/9396199/green-chemicals-bio-based-adipic-acid-to-enter-market-in-2014/>

⁴⁶ <http://www.rennovia.com/LinkClick.aspx?fileticket=D7OAWvdK8YY%3D&tabid=62>

Bio-based adipic acid is currently not commercially produced (currently at pilot scale of around 1 tonne a year⁴⁷), but it is expected that production will be approximately 450 tonnes in 2016⁴⁸. This will be led by companies such as Verdezyne, Rennovia and DSM, although other companies are also expected to enter this market⁴⁹ (e.g. BioAmber). The global market volume of fossil adipic acid was 2.7 million metric tons in 2013⁵⁰, with a market price (in 2014) of around 1,850 \$/tonne in China and up to 2,300 \$/tonne in Europe⁵¹.

Actors

Bio-based adipic acid is not currently mass produced, but still in at the R&D stage. Nevertheless, there are several companies involved in bio-adipic acid projects, especially in North America, and some have reached pilot scale.

Europe:

- **DSM:** In 2011 DSM announced their intention of entering the bio-adipic acid market and achieving commercialisation, together with value chain partners, within 5 years. They expect commercial plant capacity to reach a scale of 100-150 ktpa⁵². They are considering both fermentation and chemical catalytic routes⁵³.
- **Biochemtex:** In 2012, they opened the world's largest biorefinery, Crescentino (Italy), producing electricity and lignocellulosic ethanol⁵⁴. Long-term, they aim to produce second generation biochemicals, such adipic acid, from second generation sugars obtained from lignocellulosic biomass using their proprietary Proesa® process⁵⁵.

Rest of world:

- **Rennovia:** Uses a proprietary chemo-catalytic process to produce bio-adipic acid, using glucose as feedstock. They have been operating at pilot scale for over 24 months (~4 tpa)⁵⁶, and were targeting construction of a 300 tpa commercial demonstration unit in 2014⁵⁷ before direct scale-up to a 135 ktpa first commercial plant in 2018. In 2013 they produced and shipped samples of the first 100% bio-based nylon 6,6 polymer under their RENNLON™ brand⁵⁸. Both demonstration and commercial plants are expected to be developed with external partnerships⁵⁹, including a recently announced collaboration with Johnson Matthey Davy⁶⁰.
- **Verdezyne:** Opened a pilot plant in California in 2011, producing between 5 - 15kg of bio-based ADA each week (max 1 tpa) using a variety of non-food, plant-based feedstocks⁶¹ and proprietary

⁴⁷ <http://www.chemicals-technology.com/projects/verdezyne-adipic-acid-plant-california/>

⁴⁸ Harmsen, P. and Hackmann, M. (2013) Green building blocks for biobased plastics: Biobased processes and market development, Wageningen UR Food & Biobased Research, ISBN 978-94-6173-610-9

⁴⁹ <http://www.groenegrondstoffen.nl/downloads/Boekjes/16GreenBuildingblocks.pdf>

⁵⁰ <http://www.rennovia.com/LinkClick.aspx?fileticket=SbQO8hcNOW8%3D&tabid=62>

⁵¹ Tecnon OrbiChem (31st July 2014) Chemical Business Focus, issue number 011

⁵² <http://www.biofuelsdigest.com/bdigest/2011/05/10/dsm-bp-invest-in-verdezyne/>

⁵³ <http://www.icis.com/resources/news/2011/10/10/9498186/green-chemicals-dsm-adds-adipic-acid-to-bio-based-chemicals-portfolio/>

⁵⁴ <http://www.ieabioenergy.com/wp-content/uploads/2013/10/Task-42-Biobased-Chemicals-value-added-products-from-biorefineries.pdf>

⁵⁵ <http://www.biochemtex.com/proesa>

⁵⁶ <http://www.biofuelsdigest.com/bdigest/2014/02/12/adm-invests-25m-in-rennovia-the-complete-story/>

⁵⁷ <http://greenchemicalsblog.com/2013/10/02/rennovia-produces-100-bio-based-nylon/>

⁵⁸ <http://greenchemicalsblog.com/2013/10/02/rennovia-produces-100-bio-based-nylon/>

⁵⁹ <http://www.vcpost.com/articles/21870/20140224/us-agricultural-giant-adm-invests-25m-in-rennovia.htm>

⁶⁰ <http://www.biofuelsdigest.com/bdigest/2014/03/23/rennovia-and-johnson-matthey-davy-technologies-to-collaborate-for-glucaric-acid-adipic-acid-project/>

⁶¹ <http://www.chemicals-technology.com/projects/verdezyne-adipic-acid-plant-california/>

fermentation technology⁶². In 2013, they announced a collaboration with Malaysian Biotechnology Corporation (BiotechCorp) for potentially locating their first biochemical production facility in the Asia Pacific Region in Malaysia⁶³. In 2012, they also established a partnership with Universal Fiber Systems to supply bio-based adipic acid for carpet fibre and performance apparel yarns (Nylon 6,6). Investors include BP, DSM, and most recently Sime Darby^{64,65}.

- **BioAmber:** In 2011, BioAmber and US bioengineering firm Celexion announced an exclusive licensing agreement, which sees BioAmber licensing the production technology from Celexion. BioAmber will utilise their bio-based succinic acid experience, infrastructure and networks to accelerate development of a bio-based adipic acid product⁶⁶. BioAmber has built an in-house research facility in Plymouth, Minnesota, US to support its adipic acid development⁶⁷.
- **Genomatica:** Have announced a new development programme focusing on major nylon intermediates including adipic acid⁶⁸. The aim is to develop complete process technologies for bio-based production, which will then be licensed to players in the nylon value chain. In 2010, they filed a patent for a sugar-based fermentation production process⁶⁹.
- **Amyris:** Announced their acquisition of US-based Draths Corporation in 2011. Draths had developed fermentation technology to produce a variety of monomers from muconic acid, and their product portfolio included bio-based adipic acid. No further information is known.
- **Aemetis:** Established in 2011 when AE Biofuels acquired biotech-company Zymetis, who developed a proprietary aerobic marine organism (Z-microbe™) which enables production of bio-isoprene, glycerine, and in the future, adipic acid and butanediols⁷⁰.

Value proposition

Adipic acid is the most widely used dicarboxylic acid from an industrial perspective, and there are both financial and environmental benefits to replacing petro-based adipic acid with a bio-based equivalent. Strong growth in global demand for nylon 6,6 is expected to continue within the automobile and electronics industries and the growth of global footwear market, where polyurethanes are expected to drive the overall adipic acid market.

Environmental issues related with fossil adipic acid are acting as a major barrier for the global market⁷¹. N₂O, a potent GHG (almost 300 times worse than CO₂), is a by-product in the petrochemical process step of nitric acid oxidation. Adipic acid is thus associated with a high fossil fuel energy demand (about 104 GJ/ton) and a high level of greenhouse gas emissions (now ~60 kgN₂O/ton adipic acid)⁷²; this by-product is eliminated when using bio-based pathways.

⁶² <http://www.biofuelsdigest.com/bdigest/2013/01/30/verdezyne-biofuels-digests-5-minute-guide/>

⁶³ http://verdezyne.com/wp-content/uploads/Verdezyne_BiotechCorpcompressreleaselatest6.17.18-FINAL.pdf

⁶⁴ <http://www.xconomy.com/san-diego/2014/04/29/verdezyne-gets-48m-to-advance-industrial-biotechnology-in-malaysia/>

⁶⁵ <http://verdezyne.com/company/investors/>

⁶⁶ <http://www.icis.com/blogs/green-chemicals/2011/03/bioamber-enters-adipic-acid/>

⁶⁷ <http://investor.bio-amber.com/2011-03-15-BioAmber-and-CELEXION-Announce-Exclusive-Licensing-Partnership>

⁶⁸ <http://www.genomatica.com/products/nylon-intermediates/#sthash.XcVXkvpD.dpu>

⁶⁹ <http://www.icis.com/resources/news/2011/10/10/9498186/green-chemicals-dsm-adds-adipic-acid-to-bio-based-chemicals-portfolio/>

⁷⁰ <http://www.icis.com/blogs/green-chemicals/2011/11/ae-biofuels-enters-renewable-c/>

⁷¹ <http://greenchemicalsblog.com/2013/10/02/rennovia-produces-100-bio-based-nylon/>

⁷² Van Duuren, J.B.J.H., Brehmer, B., Mars, A.E., Eggink, G., dos Santos, V.M., Sanders, J.P.M. (2011) "A limited LCA of bio-adipic acid: Manufacturing the nylon-6,6 precursor adipic acid using the benzoic acid degradation pathway from different feedstocks", *Biotechnology and Bioengineering* 108(6): 1298-1306.

Bio-based adipic acid shows significantly improved GHG emissions compared the fossil counterpart. Petrochemical production of adipic acid yields GHG emissions estimates of 4 to 18 tCO₂/t-product^{73,74,75} depending on the process, while Rennovia estimates emissions of approximately 1.2 tCO₂e/t for bio-based adipic acid, or an 85% reduction in GHG emissions⁷⁶. Similarly, Verdezyne also expects a significant reduction in GHG emissions.

The production cost of bio-based ADA was expected earlier in 2014 to be competitive with fossil-based ADA. Rennovia predicted that their bio-based adipic acid production process will provide several financial advantages, including 15% lower capital cost, 15% lower utility costs and 20-30% lower overall manufacturing costs⁷⁷. Verdezyne also expects new bio-based processes to reduce ADA production costs by 20-30% in the long-term⁷⁸. Biochemtex estimates the operating costs of an adipic acid plant at about 630 \$/ton using the PROESA® technology integrated with cis, cis muconic acid pathway and assuming optimisation of the fermentation step in order to reach an overall conversion ratio of biomass to adipic acid of 5:1. This estimated data is competitive with fossil-based adipic acid.

One of the key advantages of the bio-based adipic acid routes is the use of inexpensive feedstocks compared to the conventional process using cyclohexane, which had a market price of 1,250 \$/tonne in 2012⁷⁹. Rennovia believes that their process production cost is competitive at an oil price of above ~85 \$/barrel, and a glucose cost of below 468 \$/tonne. However, with the recent fall in crude oil prices, this competition looks set to be increasingly difficult to achieve. Rennovia has cited a current cost of 300 \$/tonne for glucose feedstock⁸⁰, while Biochemtex second generation sugars cost an estimated 45 \$/tonne⁸¹. Nevertheless, there may be technical challenges in using these low cost feedstocks, including decreased feedstock selectivity and catalyst productivity (Rennovia), and enzyme turnover rates and lower enzyme fermentation kinetics (Verdezyne)⁸².

Outlook

The global market for adipic acid is expecting to grow at a CAGR of 3 to 5% in the coming years. Asia Pacific has dominated adipic acid consumption and accounted for over 35% of total market volume consumed in 2013⁸³, and in future it is also expected to be the fastest growing market with an estimated CAGR of 5.3% from 2014 to 2020⁸⁴. Growth of major end use industries including automotive, electronics and footwear in China and India is expected to remain a key driving factor for the regional market. On the other hand, the U.S. and Europe are fairly mature markets for adipic acid and are expected to grow at a relatively low rate over the next years⁸⁵. Europe emerged as the second largest market for adipic acid and accounted for 27%

⁷³ <http://www.chemicals-technology.com/projects/verdezyne-adipic-acid-plant-california/>

⁷⁴ <http://www.rennovia.com/LinkClick.aspx?fileticket=SbQO8hcNOW8%3D&tabid=62>

⁷⁵ Van Duuren, J.B.J.H., Brehmer, B., Mars, A.E., Eggink, G., dos Santos, V.M., Sanders, J.P.M. (2011) "A limited LCA of bio-adipic acid: Manufacturing the nylon-6,6 precursor adipic acid using the benzoic acid degradation pathway from different feedstocks", *Biotechnology and Bioengineering* 108(6): 1298-1306.

⁷⁶ <http://www.biofuelsdigest.com/bdigest/2014/02/12/adm-invests-25m-in-rennovia-the-complete-story/>

⁷⁷ <http://www.biofuelsdigest.com/bdigest/2014/02/12/adm-invests-25m-in-rennovia-the-complete-story/>

⁷⁸ <http://www.chemicals-technology.com/projects/verdezyne-adipic-acid-plant-california/>

⁷⁹ <http://www.biofuelsdigest.com/bdigest/2014/03/23/rennovia-and-johnson-matthey-davy-technologies-to-collaborate-for-glucaric-acid-adipic-acid-project/>

⁸⁰ http://www.orbichem.com/userfiles/Promotions/bm_000.pdf

⁸¹ <http://www.biofuelstp.eu/presentations/crescentino-presentation.pdf>

⁸² <http://www.ihs.com/products/chemical/technology/pep/bio-based-adipic-acid.aspx>

⁸³ <http://www.grandviewresearch.com/industry-analysis/adipic-acid-market>

⁸⁴ <http://www.plasticstoday.com/articles/engineered-plastics-global-demand-back-on-rise>

⁸⁵ <http://www.grandviewresearch.com/industry-analysis/adipic-acid-market>

of total market volume consumed in 2012. The adipic acid market depends strongly on nylon 6,6 production, whose global demand is forecast to grow at an average rate of close to 6% annually⁸⁶.

The global market for adipic acid is expected to reach \$ 7,240 million by 2020⁸⁷. Growing demand for nylon resins and fibre from major end use industries such as automotive and electronics is expected to be the main driver of adipic acid market in the next years. However, volatility in raw material prices (i.e. benzene) and stringent environmental regulations (in Europe and North America) is expected to hinder the fossil market growth⁸⁸. Development of bio-based adipic acid has emerged as a new driving force for the global adipic acid market because bio-based adipic acid is an environmentally friendly solution, and has the potential to provide cost advantage over its synthetic counterpart⁸⁹.

In the long term, alternative 'green' feedstock sources for making ADA could be less expensive to produce than conventional methods using crude oil derivative cyclohexane⁹⁰ because fluctuations in the cost of benzene could favour biochemical pathways which are linked to different feedstocks and can better weather cost variations⁹¹. Societal demands for producing industrial chemicals via more sustainable methods could also be a strong driver for artificial incentives (for example green mandates, price subsidies, loan guarantees, and government sponsored technology development) and guide bio-ADA technology-specific market demand⁹².

⁸⁶ <http://www.plasticstoday.com/articles/engineered-plastics-global-demand-back-on-rise>

⁸⁷ http://www.academia.edu/6467449/Global_Adipic_Acid_Industry_to_2020_-_Market_Estimate_Competitive_Landscape_Industry_Size

⁸⁸ <http://www.grandviewresearch.com/industry-analysis/adipic-acid-market>

⁸⁹ <http://www.ihs.com/products/chemical/technology/pep/bio-based-adipic-acid.aspx>

⁹⁰ <http://www.ihs.com/products/chemical/technology/pep/bio-based-adipic-acid.aspx>

⁹¹ http://www.biofpr.com/details/news/5862411/New_Interview_-_Read_about_the_latest_technological_developments_in_DSMs_bio-bas.html

⁹² <http://www.ihs.com/products/chemical/technology/pep/bio-based-adipic-acid.aspx>

5.4. 1,4-Butanediol (BDO)

Descriptions and markets

A diol with 4 carbon atoms, BDO is a colourless, viscous liquid. BDO is used industrially as a solvent and in the manufacture of some types of plastics, elastic fibres and polyurethanes. Bio-based BDO can be a direct drop-in replacement for fossil BDO. In organic chemistry, 1,4-butanediol is used for the synthesis of γ -butyrolactone (GBL). In the presence of phosphoric acid and high temperature, it dehydrates to the important solvent tetrahydrofuran (THF). Polybutylene terephthalate (PBT) can also be produced by polymerising terephthalic acid and BDO – this engineering plastic is used in a wide range of applications from automobile parts such as switches and ignition coils to electrical parts such as connectors and plugs, due its high tensile strength, tensile elasticity and heat resistance.

In the petrochemical industry, BDO can be produced in various ways from acetylene (Repe process, 42% of global capacity), maleic anhydride (MAN) (Davy Process, 28%), propylene oxide (Propylene Oxide process, 20%), and butadiene (Mitsubishi process, 7%)⁹³. Currently BDO produced from maleic anhydride accounts for 30% of total MAN consumption. Bio-based BDO production can either take place via direct fermentation of sugars or via the hydrogenation of succinic acid. These routes are shown in Figure 17.

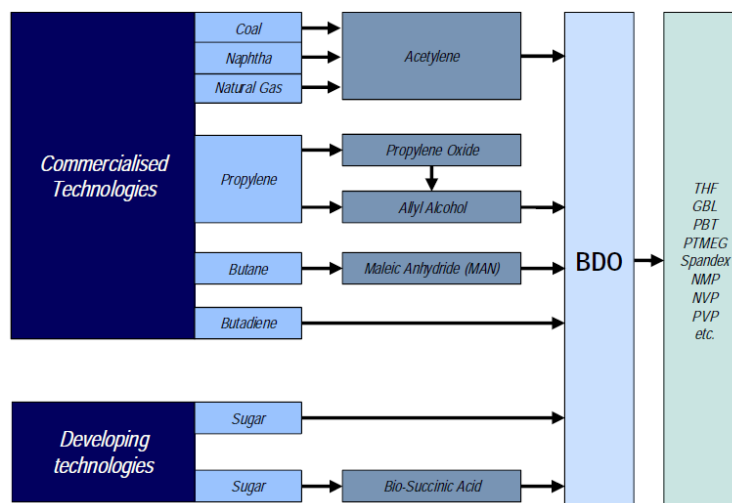

Figure 17: Production pathways for BDO

The market volume of bio-based BDO is around 3 ktpa, with a price of around 3,000 \$/tonne, and a market value of \$9 million. This market share currently only comprises a tiny fraction of the total BDO market, which in 2013 was an estimated 1,956 ktpa^{94,95,96}. The market price for fossil-based BDO in 2013 ranged from around 1,800 \$/tonne to 3,200 \$/tonne⁹⁷, depending on the region. The largest application of BDO is the manufacture of THF, accounting for 30%, followed by polyurethane at 25%, and PBT which uses about 22% of all BDO worldwide⁹⁸. The total addressable market for PBT in 2011 was 41 million tonnes⁹⁹, however

⁹³ http://www.bioconcept.eu/wp-content/uploads/BioConSepT_Market-potential-for-selected-platform-chemicals_report1.pdf

⁹⁴ http://thinking.nexant.com/sites/default/files/report/field_attachment_abstract/201304/2012_3_abs.pdf

⁹⁵ http://www.bioconcept.eu/wp-content/uploads/BioConSepT_Market-potential-for-selected-platform-chemicals_report1.pdf

⁹⁶ <http://www.grandviewresearch.com/press-release/global-1-4-butanediol-market>

⁹⁷ http://www.orbichem.com/userfiles/CNF%20Samples/bdo_13_11.pdf

⁹⁸ <http://www.grandviewresearch.com/industry-analysis/1-4-butanediol-market>

⁹⁹ http://www.bioconcept.eu/wp-content/uploads/BioConSepT_Market-potential-for-selected-platform-chemicals_report1.pdf

only a fraction of this is currently met by bio-based PBT, including that produced via direct fermentation of BDO. Currently, regular PBT resin is produced using petroleum-based ingredients¹⁰⁰.

Actors

Genomatica is a California-based company that has developed a patented GENO BDO™ process, which uses a specially engineered microbe, for BDO production directly via fermentation of sugars. A number of European companies are active in fermenting BDO directly from dextrose, as well as PBT production, based on Genomatica's technology.

Europe

- **BASF**^{101,102}: Announced in November 2013 that it had successfully produced commercial scale volumes of BDO from direct fermentation. The license agreement between BASF/Genomatica allows BASF to build a world-scale production facility, and is currently selling directly fermented BDO to customers for testing and commercial use. BASF has produced more than 4.5 ktonnes to date, and have stated that they will consider building a 50 ktpa bio-BDO plant based on market response to their product.
- **Novamont (Mater Biotech)**¹⁰³: Established a JV with Genomatica for the first industrial plant in Europe to produce BDO via fermentation in January 2012. Novamont will use the BDO internally to meet increasing demand for biopolymer products that incorporate BDO. Under the agreement Novamont is converting a facility in Adria, Italy to use Genomatica's patented technology and will fund up to \$50 million in plant investment.
- **DSM**¹⁰⁴: Announced in October 2013 that they had approved BDO made with Genomatica's process for use in their co-polyester product lines. By using BDO made with Genomatica's process, DSM is able to increase the bio-based content of their products to as high as 73%. DSM has confirmed that PBT made with BDO from Genomatica's process has equivalent properties to PBT made from petro-BDO.
- **Biochemtex (M&G)**¹⁰⁵: Announced an agreement with Genomatica, which will see the Biochemtex Proesa technology for cellulosic biomass conversion to fermentable sugar combined with Genomatica's bio-BDO process. Bio-BDO has been produced at a Biochemtex demonstration-scale facility in Rivalta, Italy since 2012.
- **Johnson Matthey-Davy Technologies**¹⁰⁶: In 2013 announced they successfully produced bio-BDO and THF at their facility in Teesside, UK, by catalytically converting succinic acid from Myriant.

Rest of the world

- **Tate & Lyle**¹⁰⁷: A joint development agreement with Genomatica has seen the production of bio-based BDO from dextrose sugars at a demonstration-scale facility owned by Tate & Lyle in Illinois, USA since 2011.

¹⁰⁰ <http://www.toray.com/news/pla/nr130425.html>

¹⁰¹ <http://www.genomatica.com/partners/basf/>

¹⁰² <http://greenchemicalsblog.com/2013/06/12/bio-bdo-commercialization-race-is-on/>

¹⁰³ <http://www.genomatica.com/partners/novamont/>

¹⁰⁴ <http://www.genomatica.com/partners/dsm-pbt/>

¹⁰⁵ <http://renewablechemicals.agra-net.com/genomatica-enters-strategic-partnership-with-mg/>

¹⁰⁶ <http://www.biofuelsdigest.com/bdigest/2013/08/21/4c-able-future-biobased-butanol-butadiene-and-bdo-are-having-a-hot-year/>

¹⁰⁷ <http://renewablechemicals.agra-net.com/2011/07/genomatica-enters-strategic-partnership-with-mg/>

- **BioAmber**^{108,109}: Have developed a process to create BDO from their bio-succinic acid, and from 2010 have licensed DuPont's hydrogenation catalyst technology to make bio-BDO and bio-THF from bio-succinic acid. They have already produced several tonnes of bio-BDO and THF at a toll facility in Germany, and plan to start 2-4 ktpa production at another toll facility in the USA later in 2014. They have stated that their 30 ktpa bio-succinic plant in Ontario, Canada could be converted to produce 22 ktpa of bio-BDO. A second manufacturing facility, being co-built with Mitsui, will see bio-BDO production of 50-100 ktpa and is expected to be complete in 2016/17.
- **Toray**¹¹⁰: Another company involved in PBT production in partnership with Genomatica is Japanese company Toray who announced in 2013, similarly to DSM, that it had successfully produced PBT using bio-based BDO and that this PBT has physical properties and formability equivalent to PBT made from petroleum-derived BDO¹¹¹.

Value proposition

Genomatica estimates that production costs for bio-BDO could be 15 – 30% lower than petroleum-BDO. It further estimates that it would be competitive at an oil price of 45 \$/barrel and a natural gas price of 3.50 \$/million Btu¹¹². The constraining factors for fossil-based BDO include raw material, price volatility and high manufacturing cost. The issues in the fossil-based BDO market are mainly those of a maturing industry, including modest growth in mature markets such as U.S. and Europe, and increasing environmental concerns¹¹³. These are issues that bio-based BDO could potentially overcome. Once BDO via fermentation reaches scale it is expected to provide significant cost-advantages relative to petroleum-based BDO.

Preliminary life cycle assessments indicate that bio-based BDO may use 60 - 87% less fossil energy, and reduce CO₂ emissions by around 70 - 117% compared to petro-based BDO produced through various processes and feedstocks^{114,115}. Further, the bio-based fermentation process requires no organic solvent and can use recycled water, further improving its environmental credentials¹¹⁶.

Another advantage of bio-based BDO is availability of raw material. Four commercial-scale BDO plants (45ktpa), representing 10% of the total BDO market, will require around 0.25% of currently available global sugar supply. By contrast, almost 50% of global sugar is used for ethanol production. Genomatica believe that the sugar market is sufficiently robust and can grow to include chemicals production without facing supply and demand disruption¹¹⁷. The alternative bio-based BDO production route, via succinic acid, is expected to induce market fragmentation and will create competition between technology developers and suppliers. However, different qualities and price levels mean both are likely to co-exist on the market¹¹⁸. Arguably, the advantage the direct fermentation process has over the succinic acid route is the ability to produce directly from an abundant feedstock.

¹⁰⁸ http://thinking.nexant.com/sites/default/files/report/field_attachment_abstract/201304/2012_3_abs.pdf

¹⁰⁹ <http://greenchemicalsblog.com/2013/06/12/bio-bdo-commercialization-race-is-on/>

¹¹⁰ <http://www.toray.com/news/pla/nr130425.html>

¹¹¹ <http://www.toray.com/news/pla/nr130425.html>

¹¹² <http://www2.epa.gov/green-chemistry/2011-greener-synthetic-pathways-award>

¹¹³ <http://www.marketsandmarkets.com/Market-Reports/1-4-butanediol-market-685.html>

¹¹⁴ http://www.genomatica.com/_uploads/pdfs/ISJ_markburke.pdf

¹¹⁵ http://thinking.nexant.com/sites/default/files/report/field_attachment_abstract/201304/2012_3_abs.pdf

¹¹⁶ <http://www2.epa.gov/green-chemistry/2011-greener-synthetic-pathways-award>

¹¹⁷ http://www.genomatica.com/_uploads/pdfs/ISJ_markburke.pdf

¹¹⁸ http://www.bioconcept.eu/wp-content/uploads/BioConSepT_Market-potential-for-selected-platform-chemicals_report1.pdf

Outlook

The global market for BDO is expected to reach 2,714 ktonnes with a market value over \$6,947 million by 2020¹¹⁹. However volatile raw material prices, together with increasingly strict environmental regulations are expected to hamper fossil-based BDO growth, and provide a platform for the increased production and use of bio-BDO. The global bio-based BDO market is projected to increase at a CAGR of 43% from its low based in 2014 to 2020, reaching production volumes of 216-241 ktonnes by 2020^{120,121}. Production capacity for PBT in the EU is expected to reach 80 ktonnes by 2020¹²², with demand growing globally at a CAGR of 4.9%¹²³.

A number of joint ventures and partnerships have been formed to increase production volumes and decrease the cost of bio-BDO production. The Novamont / Genomatica production plant in Italy (18ktpa) is expected to come online by the end of 2014. While Novamont has committed to purchasing all of the output from the plant, it may purchase a portion to support further market development. The deal between the two companies also includes the possibility that Novamont may build and operate a second BDO plant¹²⁴. BASF has publically stated that it plans to build a 50ktpa plant if there is a positive market response to their product¹²⁵. A JV between Myriant and Mitsui is also expected to bring a large-scale bio-BDO production plant of 50-100 ktpa online in the next few years.

In order to realise the full potential of bio-based BDO, the processes must be scaled up to demonstrate their suitability to meet growing demand, and continue to prove their suitability for major applications, such as PBT, at commercial scale. Fragmentation of production processes will aid with competitiveness. Stable environmental regulation, particularly in Europe, is also vital for the scale up and introduction of new production plants.

¹¹⁹ <http://www.grandviewresearch.com/press-release/global-1-4-butanediol-market>

¹²⁰ Nova Institute (2013) "Market Developments of and Opportunities for biobased products and chemicals"

¹²¹ http://www.bioconcept.eu/wp-content/uploads/BioConSepT_Market-potential-for-selected-platform-chemicals_report1.pdf

¹²² Nova Institute (2013) Production capacities for bio-based polymers in Europe

¹²³ <http://www.grandviewresearch.com/press-release/global-1-4-butanediol-market>

¹²⁴ <http://www.europeanplasticsnews.com/subscriber/headlines2.html?id=3637&ks=1>

¹²⁵ <http://greenchemicalsblog.com/2013/06/12/bio-bdo-commercialization-race-is-on/>

5.5. Farnesene

Descriptions and markets

Farnesene is a branched chain alkene with 15 carbon atoms. Farnesene is found naturally in the skins of green apples and other fruits and is partially responsible for the characteristic green apple odour. While Farnesene is produced in minute quantities in plants and some insects, its large scale production can be induced in microorganisms through genetic modification. There is no identical fossil-based substitute to farnesene but it has significant potential as a building block for alternative or superior products. For example, farnesene can be used to make solvents, emollients, performance materials, adhesives, fragrances, surfactants, stabilizers, resins, foams, coatings, sealants, emulsifiers and vitamin precursors. Farnesene has demonstrated applicability as fuel and lubricant feedstock, replacing jet fuel, diesel and a range of industrial oils, and may also have some applications in crop protection.

Figure 18 summarises the high-level production of farnesene from sugars via microbial fermentation, which requires genetic transformation of microbes with advanced strain engineering technologies. In the mevalonate pathway in the microbe of choice, acetyl coA (produced from the metabolism of glucose) is converted into isopentyl pyrophosphate (IPP) which is further transformed into Farnesyl Phosphate (FPP) and C15 isoprenoids. The proprietary pathway and approach was developed by Amyris¹²⁶. Recent efforts have focused on replicating the success in fermenting conventional sugars (C6 sugars like sucrose) by having microbes product farnesene from cellulosic sugars (C5 sugars like xylose). Using cellulosic sugars would help lower the production costs further but also further improve the carbon footprint of the renewable farnesene.

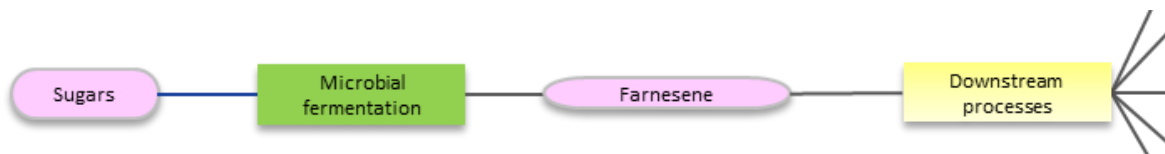

Figure 18: Production pathway for farnesene

The market size for farnesene is estimated at 12.2 ktonnes currently, with a value of \$68 million annually. The market polymer price is assumed to be above 5,500 \$/tonne, based on Amyris production costs¹²⁷. Bulk commodity and fuel markets remain challenging, but in niche markets it is already profitable today¹²⁸. As a building block module, it is foreseeable that farnesene based molecules could begin to take a significant share of a number of markets in the coming years. These include¹²⁹:

- *Cosmetics*: Emollients, including both squalane and squalene, are a \$5 billion market. Amyris have already captured 18% of the squalane market. Recent = prices of squalane are ~30 \$/litre.
- *Flavours and fragrances*: \$6 billion market, growing at 5% CAGR. Farnesene could address about \$1 billion of this.
- *Tyres*: Global tyre market is worth \$140 billion. Natural and synthetic rubber represents half the material used in tyre production.

¹²⁶ http://www.nabcprojects.org/fermentation_lignocellulosic_sugar.html

¹²⁷ <http://greenchemicalsblog.com/2013/08/10/amyris-lowers-farnesene-costs/>

¹²⁸ <http://www.fool.com/investing/general/2014/07/07/should-amyris-investors-fear-intrexons-farnesene.aspx>

¹²⁹ <http://files.shareholder.com/downloads/ABEA-4QL2IU/0x0x691918/2aaeadc4-124f-4730-b72f-10030d9624fa/Investor-Presentation.pdf>

- *Base oils and lubricants*: Global lubricants market is \$50 billion annually. Fastest growing segments are synthetic base oils (Group III and above) and environmentally-friendly products, growing approximately 10% CAGR.
- *Diesel and jet fuel*: Market is over \$1.3 trillion globally, with fast growth expected in emerging markets.

Actors

There is currently only one main market player, US-based Amyris. There are no major European producers, however, there is some European interest from partners.

- **Amyris¹³⁰**: Have a branded farnesene building block molecule as Biofene¹³¹. Its first purpose-designed, industrial-scale plant (~12 ktpa) is located in Brotas, Brazil adjacent to an existing sugar and ethanol mill, significantly reducing the capital required to establish and scale manufacturing. This plant is planned to ramp-up to 41 ktpa within 3 years. A second production site (twice the size) in San Martinho, Brazil is also due to be co-located with an ethanol and sugar mill¹³². Smaller pilot and demonstration facilities already exist in Illinois, Spain and Brazil. Amyris is targeting many different applications either directly or through partnerships with established players.
 - **Fuels**: Amyris has been converting farnesene to farnesene using standard hydrogenation techniques for use in diesel and jet fuel. Amyris is currently supplying farnesene as a renewable diesel to 400 buses in Brazil and has proved at pilot scale production that it can produce farnesene, and then farnesene, from lignocellulosic feedstock (corn stover hydrolysate)¹³³. In July 2014, with its partner **Total**, Amyris has achieved ASTM approval for use of farnesene as a renewable jet fuel, which has been used in multiple flights in Europe and the Americas at a blend of up to 10% farnesene¹³⁴.
 - **Cosmetics**: From farnesene, Amyris produces squalane (via squalene), which is an emollient previously only produced through extraction (shark liver oil) or complex chemistry (olive oil). Amyris sells its Neossance branded squalane (and now also a Hemisqualane that is similar in chemical qualities as farnesene) via regional distributors¹³⁵.
 - **Fragrances**: Amyris has a number of partnerships to develop and produce fragrances. While its focus to-date has been on other isoprenoids (such as the patchouli oil it has produced for its partner **Firmenich**¹³⁶). Amyris has been working with companies like Givaudan, Takasago, and IFF on farnesene-derived fragrances.
 - **Polymers**: With Japanese chemical company **Kuraray**¹³⁷, Amyris is developing high-performance polymers based on farnesene, and which could be used to replace petroleum-derived materials, such as butadiene and isoprene currently used for rubber manufacture. Kuraray and Amyris expect to begin to commercialise its first product, Liquid Farnesene Rubber, 2014¹³⁸ to leading tyre manufacturers. Separately, Amyris has a partnership with

¹³⁰ <http://www.amyris.com/>

¹³¹ <http://seekingalpha.com/article/2051433-amyris-advances-but-at-what-cost>

¹³² <http://www.amyris.com/Company/151/BusinessStrategy>

¹³³ <http://www.amyris.com/amyris-receives-green-chemistry-innovation-award-from-u-s-environmental-protection-agency/>

¹³⁴ <http://www.greenaironline.com/news.php?viewStory=1981>

¹³⁵ <http://www.neossance.com/>

¹³⁶ <http://biomassmagazine.com/articles/10056/amyris-reports-reduced-farnesene-production-costs-in-2013-results>

¹³⁷ <http://www.bloomberg.com/apps/news?pid=newsarchive&sid=asX64.ZxtZAM>

¹³⁸ <http://files.shareholder.com/downloads/ABEA-4QL2IU/0x0x691918/2aaeadc4-124f-4730-b72f-10030d9624fa/Investor-Presentation.pdf>

Michelin and **Braskem** to develop a microbial route for the production of isoprene for the use in tyre manufacturing¹³⁹. **Amyris** has also partnered with Italy's Gruppo M&G (Beta Renewables) to incorporate Biofene as an ingredient in PET (polyethylene terephthalate) resins for packaging applications.

- **Intrexon**¹⁴⁰: Lab scale production via a methanotrophic route¹⁴¹ in lab-scale tests. They suggest this route, based on methane, has a higher yield of farnesene than sugar routes¹⁴².
- **Chromatin Inc.**¹⁴³: Have developed sorghum plants with elevated levels of farnesene using an innovative "gene stacking" technique, where 9 genes were expressed creating an entire biosynthetic pathway in the plant. This is still early stage and years away from commercialisation.

Value proposition

Farnesene is already currently an attractive value proposition in the emollients industry – squalane derived from this molecule is already incorporated into commercially produced cosmetics¹⁴⁴. The potential for farnesene in the tyre industry is also close to market due to its superior physical properties compared with conventional alternatives and could be incorporated into commercial products in this industry in the next few years¹⁴⁵. However, production costs are high for bulk commodities like transport fuels, compared with conventional gasoline and diesel. For example, Amyris and Total are currently producing farnesene at a cost of just under 3.50 \$/litre¹⁴⁶. However, they are targeting 1 \$/litre in the long-term¹⁴⁷.

Its environmental credentials are promising from a GHG perspective. Amyris's sugarcane-derived farnesene used as a diesel or jet fuel can result in an 80% reduction in GHG emissions compared with conventional diesel¹⁴⁸. As fermentation of cellulosic feedstocks become economically viable, it is likely that the process will transition to using sugar crops to cellulosic wastes and residues and, as a result, risks and emissions associated with indirect land use change (ILUC) (not included in this estimate) will be significantly reduced.

Depending on the molecule derived from farnesene, there are many different physical properties, but a few of the key physical characteristic benefits are summarised below:

- For fuels, the physical and performance properties of farnesene are consistent with C15 iso-paraffin and superior in some aspects to usual blending components for jet fuel: low freezing point (<-100°C), High thermal stability above 380°C, high energy content (44 MJ/kg)¹⁴⁹. The lack of sulphur, for instance, greatly improves the local ambient performance of farnesene as a fuel.
- Farnesene Liquid Rubber (LFR)¹⁵⁰, which Amyris produces with Kuraray, can be used as a reactive plasticizer to soften rubber and cross-link with it during the curing process. This gives LFR many advantages over typical rubber plasticizers, which can degrade the rubber properties during the

¹³⁹ <http://www.amyris.com/braskem-joins-amyris-and-michelin-to-accelerate-the-industrialization-and-commercialization-of-renewable-isoprene/>

¹⁴⁰ http://investors.tutorperini.com/files/doc_presentations/2014/TPC%20Jefferies%202014%20Global%20Industrials%20Conference%20Presentation_v001_b289ex.pdf

¹⁴¹ <http://www.fool.com/investing/general/2014/07/07/should-amyris-investors-fear-intrexons-farnesene.aspx>

¹⁴² <https://www.dna.com/userfiles/files/energy/Jefferies-August-2014-Global-Industrials-Conference-Presentation.pdf>

¹⁴³ <http://www.chromatininc.com/news/Chromatin-Inc.-Announces-Production-of-Farnesene-in-Sorghum>

¹⁴⁴ <http://seekingalpha.com/article/2051433-amyris-advances-but-at-what-cost>

¹⁴⁵ <http://www.fool.com/investing/general/2014/05/01/what-will-amyris-gain-and-sacrifice-to-court-tire.aspx>

¹⁴⁶ <http://seekingalpha.com/article/2051433-amyris-advances-but-at-what-cost>

¹⁴⁷ <http://www.altenergystocks.com/archives/biomass/biochemicals/>

¹⁴⁸ http://www1.eere.energy.gov/bioenergy/pdfs/ibr_arra_amyris.pdf

¹⁴⁹ http://www.alternativefuelsworldwide.com/presentations/TOTAL%20AMYRIS%20presentation%20Paris%20Air%20Show%2020-25%20min_v2.pdf

¹⁵⁰ http://digital.ipcprintservices.com/article/Biofene,_a_renewable_monomer_for_elastomer_materials_with_novel_properties%3A_Polymer_development,_characterization_and_use/1785778/221347/article.html

shaping process. Another property advantage is that it has unique viscoelastic performance compared with existing tyre production processes, resulting in lower rolling resistance, and improved fuel efficiency without compromising on durability and grip. It also has a longer lifetime. Further, there is reduced oil migration out of tyres, resulting in an improved environmental profile due to a reduction in oil leaching into groundwater and the air.

- Squalene is naturally produced in human skin and has excellent moisturising properties. To date, for cosmetics it is traditionally produced from shark's liver or olive oil and is very expensive, leading to use of other, lower performing emollients instead. The farnesene route provides an alternative means of producing this higher performing emollient for the cosmetics industry. Amyris is said to be growing market share as it delivers consistently lower prices and better performance than conventionally-produced squalene.

Outlook

Farnesene is likely to be successful due to the range of addressable markets into which it could expand and its superior performance in a number of cases, in terms of its environmental performance and physical properties¹⁵¹. As it is a building block molecule, more applications could be found in the coming years. However, Amyris is the only key player at the moment (which presents a risk), although they have ambitious plans to commercialise and decrease costs to make farnesene competitive with fossil equivalents. It is currently doing so by forming numerous strategic partnerships in different market segments, some of which are already starting to yield results. The use of cellulosic feedstocks will eventually be crucial to cost reduction and providing the necessary environmental credentials, particularly for the bulk fuel market. In the longer term we may see other players come into the market, potentially via alternative methanotrophic routes. The price of farnesene is expected to drop significantly, potentially as low as 1,000 \$/tonne, once the relevant technologies have been commercialised.

¹⁵¹ <http://files.shareholder.com/downloads/ABEA-4QL2IU/0x0x691918/2AAEADC4-124F-4730-B72F-10030D9624FA/Investor-Presentation.pdf>

5.6. 2,5-Furandicarboxylic Acid (FDCA)

Descriptions and markets

2,5-Furandicarboxylic acid (FDCA) is a promising bio-based building block for resins and polymers. It can substitute for terephthalic acid (TPA) in the production of polyesters (such as PET), giving rise instead to a new class of polyethylene furanoate (PEF) polymers and the production of bio-based recyclable plastic bottles. Typical applications for FDCA are in polyesters, polyamides, solvents and plasticisers with its main potential found in renewable plastics. FDCA is currently mainly used in niche markets (laboratory testing and pharmaceuticals).

There are numerous routes to its production, including dehydration of hexose derivatives, oxidation of 2,5-disubstituted furans and catalytic conversion of furan derivatives (shown in Figure 19).

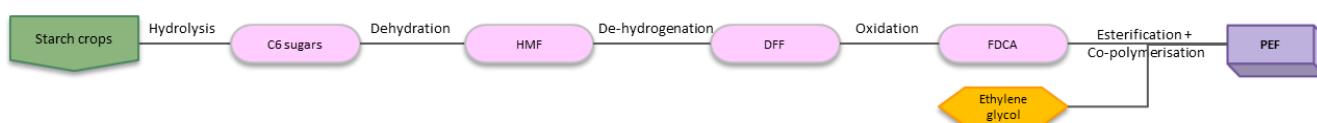

Figure 19: One of the production pathways for FDCA and PEF

FDCA has thus far not been commercialised because of its high price, and production is further limited by availability of the intermediate hydroxymethylfurfural (5-HMF). However pilot scale production has served to validate the production pathways and provided valuable information on the potential process performance at industrial scale. In 2013 global production capacity of FDCA was 40 tonnes, in Avantium's pilot plant in the Netherlands¹⁵². The potential addressable market for FDCA is substantial due to the number of applications for which it could be as a replacement or platform chemical. These include replacing TPA in the production of PET, PBT and polyamides, bisphenol A in polycarbonates, adipic acid in the polyester polyols and plasticizers, and phthalic anhydride in the polyester polyols and plasticizers. FDCA also has potential to be used in the production of novel solvents. If FDCA were to completely replace these chemicals, the estimated addressable market volume is around 50 million tonnes with a value over \$50 billion¹⁵³.

Actors

There are currently only a few companies actively involved in the production and commercialisation of FDCA, and the market is dominated by a single player - Avantium, a spin-off company from Royal Dutch Shell established in 2000.

Europe

- **Avantium**^{154,155}: Have developed a proprietary 2-step chemical, catalytic process to produce Furanics building blocks (FDCA) from sugars ("YXY"). The FDCA is used to produce PEF. They are expected to bring significant capacity online, estimated between 30 - 50 ktpa, in 2018, further expanding to 300 – 500 ktpa shortly after. They opened a FDCA pilot plant in the Netherlands in 2011, with a nameplate capacity of 40 tpa capacity for application and process development. Once

¹⁵² http://www.bioconcept.eu/wp-content/uploads/BioConSepT_Market-potential-for-selected-platform-chemicals_ppt1.pdf

¹⁵³ http://www.bioconcept.eu/wp-content/uploads/BioConSepT_Market-potential-for-selected-platform-chemicals_report1.pdf

¹⁵⁴ http://www.bioconcept.eu/wp-content/uploads/BioConSepT_Market-potential-for-selected-platform-chemicals_report1.pdf

¹⁵⁵ <http://www.biofuelsdigest.com/bdigest/2014/02/25/avantium-biofuels-digests-2014-5-minute-guide/>

they have sufficiently developed the YXY technology at commercial scale they plan to license the proprietary platform.

- **Corbion Purac**^{156,157}: Currently looking at the feasibility of developing FDCA. In 2013 they purchased chemical engineering company BIRD Engineering to boost their relevant R&D capabilities. Corbion has developed a 2-step process, starting with chemical dehydration of C6 sugars to 5-HMF, followed by a biotransformation of 5-HMF to FDCA.
- **AVA Biochem**: Recently started production of 5-HMF at its Biochem-1 facility in Muttenz, Switzerland with a production capacity of 20 tpa. AVA Biochem's process is based on a modified version of the hydrothermal carbonisation (HTC) process¹⁵⁸. The 5-HMF could then be converted into FDCA via a biotechnological process which would further help boost FDCA production and overcome the barrier of limited availability of intermediate feedstock¹⁵⁹.
- **Novozymes**: Potential FDCA technology supplier, as they have developed an enzymatic approach to convert 5-HMF into FDCA with 3 enzymes using a glucose feedstock¹⁶⁰. They have worked with Denmark Technical University to develop an 5-HMF route.

Rest of the world

- **Archer Daniels Midland (ADM)**: Has created a patent portfolio in the area of 5-HMF and FDCA production. No published activities are known around up-scaling and commercialising its technology.

Avantium plans to further develop and commercialise its YXY technology in collaboration with a number of partners to build a Furanics supply chain. On the commercialisation side Avantium has co-operation agreements with Coca-Cola, Danone and ALPLA for the development of PEF bottles, as well as with Wifag-Polytype for the development of thermoformed PEF. In 2014, these strategic partners have, together with Swire and current shareholders, invested \$50 million in the further development of Avantium's YXY technology¹⁶¹. Together with these ambitious commercial growth plans there are also research and development programs, such as the public private CatchBio partnership in the Netherlands, which is working to produce 5-HMF from lignocellulose.

Value proposition

A major advantage of PEF compared to PET is the technically superior properties of PEF compared to PET. Both the strongly improved barrier properties as well as tensile strength properties are notable. Therefore, PEF is more than a direct replacement for PET. On the contrary, PEF can be used for application currently serviced by much more expensive multilayer, aluminium, steel or glass solutions. FDCA is currently not produced on commercial scale; however Avantium's aggressive plans for scale up and industrialisation through licensing may help decrease FDCA production costs over time to levels competitive with PET. Another major advantage of PEF is that existing PET polymerisation assets can be used with minimal upfront capital investment in retrofitting or new-build.

¹⁵⁶ <http://www.foodingredientsfirst.com/news/Purac-to-Acquire-BIRD-Engineering-BV.html>

¹⁵⁷ <http://www.corbion.com/media/168355/cmd-2013-biochemicals.pdf>

¹⁵⁸ <http://biomassmagazine.com/articles/10001/ava-biochem-produces-renewable-5-hmf>

¹⁵⁹ <http://www.groenegrondstoffen.nl/downloads/Boekjes/16GreenBuildingblocks.pdf>

¹⁶⁰ <http://www.slideshare.net/thomasschafer5688476/biological-solutions-in-a-chemical-world-green-polymer-chemistry-2012>

¹⁶¹ <http://avantium.com/news/Avantium-Raises-36M-Investment-from-Swire-The-Coca-Cola-Company-Danone-and-ALPLA>

The production of PEF from FDCA also has environmental advantages, reducing the non-renewable energy use by 51% - 58% compared to PET, and producing GHG emissions of 1.4 – 2.1 tCO₂/ t-product compared to fossil PET emissions of 3.8 – 4.4 tCO₂/ t-product¹⁶² (a saving of approximately 60%).

As FDCA has a different molecular structure to TPA, the resulting polymer also has differing properties. Compared to PET, PEF has a higher thermal stability (higher glass transition temperature) combined with a lower processing temperature (lower melting point). PEF is also seen as a superior material for bottles due to its significantly improved gas barrier properties, hence the involvement from plastic bottle users such as Coca-Cola and Danone¹⁶³. In summary, PEF could offer improved product properties and significantly improved GHG emissions, compared to fossil PET, although is currently more costly.

Outlook

The FDCA market is projected to grow significantly from its small base today, with projected market volumes of up to 500 ktonnes by 2020¹⁶⁴. By segment, replacement of PET is expected to be around 322 ktonnes¹⁶⁵, followed by polyamides at 80 ktonnes. If these volumes are realised, it will likely provide sufficient economies of scale to produce FDCA at competitive cost compared to non-renewable counterparts. The total FDCA market value by 2020 is an estimated \$498 million (assuming a price of \$1,000/tonne is achieved)¹⁶⁶.

Avantium is currently the cornerstone of FDCA technology development, forming partnerships with large industrial actors, including Coca-Cola, Danone, Alpla and Wifag-Polytype, to both commercialise the technology and reduce costs substantially. Avantium's long-term ambition is to sell licenses to build or retrofit plants, each producing 300 – 500 ktpa of FDCA¹⁶⁷. However, Avantium are the only key player at the moment (which presents a risk).

Availability and reliability of biomass supply (C6 sugars), coupled with price and price stability, will be vital to Avantium's expansion plans over the next six years. The mass production of FDCA will see significant feedstock input, which would make the raw material suppliers, such as Cargill, a key part of the market¹⁶⁸. In addition, the European Food Safety Authority (EFSA) recently released their study of FDCA and PEF, citing no safety concerns¹⁶⁹. PEF may be used for all types of foodstuffs and storage under any condition. However, this does not mean that PEF is approved today as food packaging material; for this approval the FDCA monomer must be listed in an amendment of the Plastics Regulation by the European Commission. Avantium foresees that this will happen during 2015, in part due to the EFSA's positive scientific opinion. Avantium has stated that they will also apply for Food and Drug Administration (FDA) approval at a later stage in order to address the full market potential of FDCA and PEF production¹⁷⁰.

¹⁶² ftp://ftp.geog.uu.nl/pub/posters/2011/Energy_and_GHG_emission-balance_of_Furanics-based_biopolyesters-Eerhart_Faaij_Patel-June2011.pdf; PEF + is process using bio-based ethylene glycol.

¹⁶³ <http://www.groenegrondstoffen.nl/downloads/Boekjes/16GreenBuildingblocks.pdf>

¹⁶⁴ <https://www.prbuzz.com/energy/244843-world-fdca-furandicarboxylic-acid-market-expected-to-reach-usd-498-2-million-by-2020-grand-view-research-inc.html>

¹⁶⁵ http://www.bioconcept.eu/wp-content/uploads/BioConSepT_Market-potential-for-selected-platform-chemicals_report1.pdf

¹⁶⁶ <https://www.prbuzz.com/energy/244843-world-fdca-furandicarboxylic-acid-market-expected-to-reach-usd-498-2-million-by-2020-grand-view-research-inc.html>

¹⁶⁷ <http://www.ptonline.com/blog/post/100-biobased-polyester-charts-course-to-commercialization#/cdn/cms/Avantium%20Bottles.jpg>

¹⁶⁸ <http://www.grandviewresearch.com/industry-analysis/FDCA-Industry>

¹⁶⁹ <http://www.efsa.europa.eu/en/efsajournal/pub/3866.htm>

¹⁷⁰ <http://www.foodproductiondaily.com/Innovations/EFSA-panel-backs-monomer-that-produces-PEF>

5.7. Isobutene

Descriptions and market

Isobutene (isobutylene; 2-methylpropene) is a four-carbon branched alkene, and a colourless and volatile gas. It is used in a large variety of applications, such as fuel additives, polymers and pharmaceuticals¹⁷¹. Due to its toxic properties isobutene is a highly regulated chemical and stringent measures need to be followed to prevent leakage into the environment¹⁷².

Isobutene is a key precursor for numerous chemicals. Isobutene is added to methanol to produce MTBE (methyl tert-butyl ether) and with ethanol to produce ETBE (ethyl tert-butyl ether) which are the main types of fuel additives in the market¹⁷³. Isobutene is used in the production of isooctane, which is a fuel additive used in the aviation fuel. It is also extensively used in the manufacturing process of rubber used to produce tyres and tubes for the automotive industry¹⁷⁴. It is further used in a variety of polymerisation reactions. One of the resulting products is butyl rubber, a polymer of isobutene and isoprene, which is used for the production of tires, gas masks, baseballs, and even chewing gum.

Isobutene is currently produced at large scale by petrochemical cracking of crude oil. It is produced during the fractionation process of refinery gasses, and by means of catalytic cracking of MTBE¹⁷⁵. Isobutene can also be produced from isobutanol, from biomass digestion¹⁷⁶, via dehydration¹⁷⁷, as shown in Figure 20. French firm Global Bioenergies is developing a direct bio-based process, and have engineered bacterium strains that convert glucose straight to isobutene via an artificial metabolic pathway that passes by 3-hydroxy-isovalerate¹⁷⁸, as shown in Figure 21.

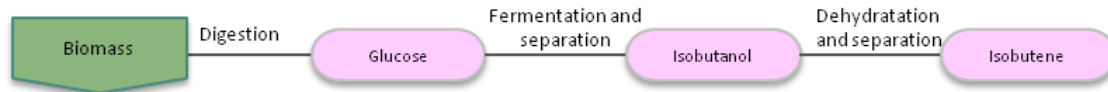

Figure 20: Fermentative production of isobutanol followed by isobutanol recovery and chemocatalytic dehydration^{2,3}

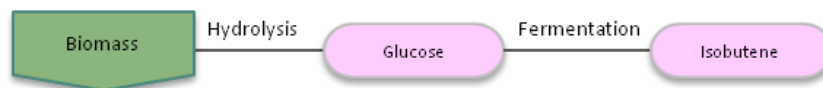

Figure 21: Fermentative isobutene production²

The global isobutene market is valued at around \$25 - 30 million annually¹⁷⁹, with total production of about 15 million tonnes¹⁸⁰ and a market value of 1,700-2,000 \$/tonne¹⁸¹. North America accounts for the majority of isobutene demand, followed by Asia Pacific and Europe¹⁸². China is one of the primary manufacturers of

¹⁷¹ <http://www.transparencymarketresearch.com/isobutene-market.html>

¹⁷² <http://www.transparencymarketresearch.com/isobutene-market.html>

¹⁷³ <http://www.transparencymarketresearch.com/isobutene-market.html>

¹⁷⁴ <http://www.transparencymarketresearch.com/isobutene-market.html>

¹⁷⁵ <http://www.transparencymarketresearch.com/isobutene-market.html>

¹⁷⁶ <http://www.icis.com/blogs/green-chemicals/2010/05/lanxess-invests-in-bio-butanol/>

¹⁷⁷ <http://www.groenegrondstoffen.nl/downloads/Boekjes/16GreenBuildingblocks.pdf>

¹⁷⁸ <http://greenchemicalsblog.com/2013/06/08/global-bioenergies-partners-with-arkema/>

¹⁷⁹ http://www.global-bioenergies.com/index.php?option=com_content&view=article&id=81&Itemid=185&lang=en

¹⁸⁰ http://www.global-bioenergies.com/index.php?option=com_content&view=article&id=73&Itemid=172&lang=en

¹⁸¹ http://www.global-bioenergies.com/index.php?option=com_content&view=article&id=73&Itemid=172&lang=en

¹⁸² <http://www.transparencymarketresearch.com/isobutene-market.html>

isobutene worldwide¹⁸³. The addressable market for isobutene is an estimated \$25 billion, while the potential for gasoline, diesel and jet fuel presents a potential market worth several hundred billion dollars¹⁸⁴. Current production of bio-based isobutene is only about 10 tonnes a year.

Actors

Major players in the production of fossil-based isobutene include BASF, Evonik Industries, Exxon Mobil Chemicals and ABI Chemicals. Bio-based isobutene is currently dominated a small number of players.

Europe

- **Global Bioenergies:** Global Bioenergies' pilot plant in Evry (France) is currently producing a small volume of isobutene¹⁸⁵. In collaboration with Arkema, they commissioning a new pilot plant in Pomacle (France) with a maximum capacity of 10 tpa¹⁸⁶, to focus on methacrylic acid production from bio-based isobutene¹⁸⁷. The company has also recently announced another pilot plant to be built at the Leuna refinery site in Germany, which will produce high-purity isobutene at a production capacity of up to 100 tpa¹⁸⁸. Further, Global Bioenergies is looking to other members of the gaseous olefins family (propylene, ethylene, linear butylenes, butadiene) as key molecules at the heart of the petrochemical industry¹⁸⁹. In the future they will also focus on the possibility of producing isobutylene from carbon monoxide¹⁹⁰. Global Bioenergies has recently signed an agreement with Audi, which will see development of isooctane derived from isobutene as a drop-in high performance gasoline substitute¹⁹¹.
- **Lanxess:** Invested \$17 million in Gevo's IPO (9% stake), and also signed a 10-year exclusive supply agreement with Gevo¹⁹², who will supply bio-based isobutanol. Lanxess' dehydration process has been successful at laboratory scale and also in a small-scale reactor in Leverkusen, Germany, over a period of several months¹⁹³. Tests have shown that the process can also deliver bio-based butyl rubber suitable for the tyre industry, which represents about 25% of Lanxess' sales.

Rest of the world – Isobutanol

China is one of the primary producers of isobutene in the world¹⁹⁴, however currently has no bio-based production activity. The two producers of bio-based isobutanol are both in the US:

- **Gevo:** A US-based biochemicals and biofuels company, which is developing a fermentation process to produce isobutanol from corn-based fermentable sugars¹⁹⁵. Its ethanol plant in Luverne, Minnesota (ethanol production capacity 7 ktpa) is currently producing about 6 ktpa of isobutanol¹⁹⁶

¹⁸³ <http://www.transparencymarketresearch.com/isobutene-market.html>

¹⁸⁴ http://www.global-bioenergies.com/index.php?option=com_content&view=article&id=73&Itemid=172&lang=en

¹⁸⁵ http://www.global-bioenergies.com/communiques/140722_pr_en.pdf

¹⁸⁶ <http://greenchemicalsblog.com/2014/08/11/global-bioenergies-commercialization-in-momentum/>

¹⁸⁷ <http://greenchemicalsblog.com/2014/08/11/global-bioenergies-commercialization-in-momentum/>

¹⁸⁸ <http://greenchemicalsblog.com/2014/08/11/global-bioenergies-commercialization-in-momentum/>

¹⁸⁹ http://www.global-bioenergies.com/cp/cp_120502_production_isobutene_uk.pdf

¹⁹⁰ <http://www.groenegrondstoffen.nl/downloads/Boekjes/16GreenBuildingblocks.pdf>

¹⁹¹ http://www.process-worldwide.com/engineering_construction/plant_design/basic_detail_engineering/articles/437380/

¹⁹² <http://lanxess.com/en/corporate/about-lanxess/company-news/lanxess-steps-up-commitment-to-biobased-raw-materials/>

¹⁹³ <http://lanxess.com/en/corporate/about-lanxess/company-news/lanxess-steps-up-commitment-to-biobased-raw-materials/>

¹⁹⁴ <http://www.transparencymarketresearch.com/isobutene-market.html>

¹⁹⁵ http://www.specchemonline.com/news/view/lanxess-further-biobased-isobutene-focus#.VHL8szSG_Sh

¹⁹⁶ <http://www.gevo.com/about/our-business/production-sites/>

and has stated plans to increase this to nearly 1 Mtpa by 2015. Gevo also has a partnership with Lanxess for the supply of isobutanol to produce isobutene¹⁹⁷.

- **Butamax:** Joint Venture between DuPont and BP. Plan to launch commercial production of bio-based isobutanol in the United States¹⁹⁸. In 2014 Butamax announced the completion of the first phase of a retrofit of partner Highwater Ethanol's plant in Lamberton, Minnesota for the production of isobutanol¹⁹⁹.

Value proposition

The aerospace market, together with growing demand for rubber from the automotive industry, is the main driver for the isobutene market²⁰⁰. Isobutene is the source of polyisobutene, an important precursor chemical for the production of fuel and lubricant additives. Further, isobutene derived biofuels are characterised by a high energy content and are those that are fully miscible with fossil fuels are key candidates for drop-in fuels. This will limit the investment required in their deployment, aiding the potential for rapid growth in these new markets²⁰¹.

The cost of fermentative isobutene is heavily dependent on the feedstock used (sugar, cereals, or agricultural and forestry waste²⁰²), and large-scale production costs are estimated around 1,100 \$/tonne - which is relatively competitive with the fossil-based costs²⁰³. It is anticipated however that the production costs will increase due to deployment of shale gas²⁰⁴, although recent oil price drops will have changed the competitiveness picture.

The advantage of a completely biological route (glucose fermentation) is that gaseous isobutene (instead of isobutanol) could be easily recovered from the fermenter with minimal separation energy input, together with CO₂²⁰⁵; moreover the low aqueous solubility of isobutene (compared to isobutanol) minimises product toxicity to the microorganisms. No GHG emission data was found, however Global Bioenergies estimates that CO₂ emissions could be reduced by 20-80% depending on the feedstock used²⁰⁶.

Outlook

Global Bioenergies estimates that the process could be profitable under current market conditions, and expects that further improvement in market conditions in the future, together with process improvements, will continue to drive profitability²⁰⁷. A future application of isobutene could be the production of antioxidants³ which can be used in the food industry and are expected to show increasing demand. Oxidation of isobutene leads to methacrolein and subsequently to methacrylic acid, a building block for poly(methyl methacrylate) plastics. Finally, tert-butanol and tert-amines can be produced from isobutene

¹⁹⁷ http://www.specchemonline.com/news/view/lanxess-further-biobased-isobutene-focus#.VHL8szSG_Sh

¹⁹⁸ <http://www.butamax.com/biofuel-company.aspx>

¹⁹⁹ http://www.butamax.com/Portals/0/pdf/2_ButamaxandHighwaterEthanolCompletePhase1ofBiobutanolRetrofitProject.pdf

²⁰⁰ <http://www.transparencymarketresearch.com/isobutene-market.html>

²⁰¹ http://www.global-bioenergies.com/index.php?option=com_content&view=article&id=91&Itemid=192&lang=en

²⁰² http://www.global-bioenergies.com/index.php?option=com_content&view=article&id=60&Itemid=157&lang=en

²⁰³ van Leeuwen, N.M., van der Wulp, A.M., Duijnste, I., van Maris, A.J.A., Straathof, A.J.J. (2012) "Fermentative production of isobutene", Applied Microbiology and Biotechnology 93(4): 1377-1387

²⁰⁴ <http://www.lianhai.cn/en/about.asp>

²⁰⁵ van Leeuwen, N.M., van der Wulp, A.M., Duijnste, I., van Maris, A.J.A., Straathof, A.J.J. (2012) "Fermentative production of isobutene", Applied Microbiology and Biotechnology 93(4): 1377-1387

²⁰⁶ http://www.global-bioenergies.com/index.php?option=com_content&view=article&id=86&lang=en

²⁰⁷ http://www.global-bioenergies.com/index.php?option=com_content&view=article&id=86&lang=en

with water and ammonia, respectively, for use in various chemical processes and products. The growth of the end use markets is expected to drive the market for isobutene²⁰⁸ and its bio-based counterpart.

In Europe Global Bioenergies is a driving force in bio-based isobutene research and production and it is steadily expanding the market, with its new pilot plants and the agreement with Audi for isooctane production, from isobutene, as drop-in biofuel for gasoline power vehicles²⁰⁹. Routes via isobutanol are being led by Gevo and Butamax, with isobutanol global production capacity potentially able to reach 170 ktpa by 2020²¹⁰.

The price of crude oil and its fluctuations directly affects the fossil-based isobutene market²¹¹, while bio-based isobutene instead could be produced from a variety of different bio-based feedstocks (from crops to fermentable sugar-residues) adapting to different world markets and the requirements of each and feedstock availability.

²⁰⁸ <http://www.transparencymarketresearch.com/isobutene-market.html>

²⁰⁹ <http://www.ecoseed.org/renewables/bioenergy/ethanol/17323-audi-global-bioenergy-partner-for-drop-in-biofuels-for-gasoline-power-vehicles>

²¹⁰ Nova Institute (2013) "Market Developments of and Opportunities for biobased products and chemicals"

²¹¹ <http://www.transparencymarketresearch.com/isobutene-market.html>

5.8. Polyhydroxyalkanoates (PHAs)

Description and markets

Polyhydroxyalkanoates or PHAs are a class of linear polyesters produced in nature by the direct bacterial fermentation of sugar or lipids. They are produced by the bacteria to store carbon and energy, usually under conditions of physiological stress. More than 150 different monomers can be combined within this family to give tuneable materials with extremely different properties. These plastics are biodegradable (suitable for home composting) and can either be thermoplastic or elastomeric materials.

Polyhydroxybutyrate (PHB) and polyhydroxyvalerate (PHBV) are common types of PHAs seen in nature. Depending on its grade, PHB is similar in its mechanical, physical and thermal properties to many different plastics, including polypropylene (PP), polyethylene (PE), low density polyethylene (LDPE), high density polyethylene (HDPE), polyvinylchloride (PVC), polystyrene (PS), and polyethylene terephthalate (PET). It is currently mainly used in the medical industry for internal suture as it is non-toxic, compatible and naturally absorbed and so does not need to be surgically removed. Other potential uses are as capsules in pharmacology and as packaging. Blends of PHB are currently used to make foams (to replace polystyrene cartons etc.), blown film (for carrier bags), fibres (for thread) and injection moulding²¹². Further sectors for PHB include automotive, design, and high-tech electronics.

Certain types of bacteria (e.g. *Alcaligenes eutrophus* and *Lactobacillus acidophilus*) when fed with sugar sources (e.g. sugarcane, date molasses, glucose etc), nutrients and water can produce PHB under aerobic conditions, as summarised in Figure 22. The metabolic pathway by which PHB is produced involves 3 key enzymes (3-ketothiolase, acetoacetyl-coA reductase and PHA synthase). The bacterial cells are then settled from the suspension and the PHB extracted using several kinds of technologies, some of these based on organic solvents, others not including any of them. It is important to note that in order to extract the PHB, the bacterial cells need to be physically broken apart/killed. This is followed by additional steps, such as partial crystallisation and purification. There is currently research happening to evaluate multiple feedstocks for PHA/PHB production, including sugars, waste, agricultural sub-products, methane, and genetically modified plants.

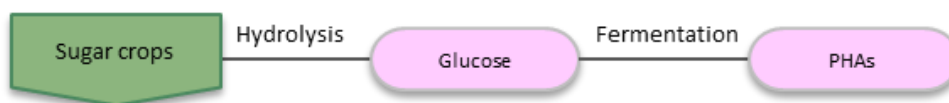

Figure 22: Production pathway for PHB from glucose

In 2014, the global production capacity for PHAs is estimated at 54 ktonnes²¹³. Although developed in the 1990s, PHAs still currently remain niche materials within certain high value markets. In 2008, Metabolix quoted Mirel (PHB) prices at above 4,400 \$/tonne, significantly more than comparable polystyrene or polyolefin market prices²¹⁴. Price expectations for PHB in the South American sugar industry, where industrial scale PHB production is beginning, are around 6,500 \$/tonne²¹⁵, roughly 4-5 times higher than PP (at around 1,500 \$/tonne²¹⁶) and twice as expensive as PLA²¹⁷. However, the cost of PHA products has come

²¹² www.nova-institut.de/download/MartinSnijder-GreenGran

²¹³ <http://www.kcpk.nl/algemeen/bijeenkomsten/presentaties/20140508-jan-ravenstijn-pha-is-it-here-to-stay>

²¹⁴ <http://info.smithersrapra.com/downloads/chapters/Mouldable%20Particle%20Section%204.4.pdf>

²¹⁵ <http://www.bio-plastics.org/en/information--knowledge-a-market-know-how/bioplastic-types/polyhydroxyalkanoates>

²¹⁶ <http://www.platts.com/news-feature/2012/pgpi/polypropylene>

down significantly in recent decades; in 1995, Monsanto sold PHA products at 17 times the price of its synthetic equivalents²¹⁸. Addressable markets include polypropylene, which in 2011/12 was estimated at 42.3 million tonnes with a market value of \$77.5 bn^{219,220}, and polyethylene, estimated at around 88 million tonnes²²¹. The potential market for PHB may be up to 50% of the current plastics market²²².

Actors

Investment and activity in PHAs is relatively low compared with PLA and some other bioplastics. There is currently limited activity in the EU and more focus on deployment in the rest of the world, especially China and the Americas. Note that we are only mentioning PHA developers focused on sugars below – other developers (such as Meredian and Newlight Technologies) that use vegetable oil feedstocks are out of scope.

Europe

- **Biomer**²²³: German-based producer of four different grades of PHB via sugar fermentation, which can be used for extrusion and also for food packaging. They have developed PHB blends (mixed with plasticizers and nucleating agents) to improve performance but not compromise on biodegradability. They have reported producing 1 ktpa at their demonstration scale plant in Krailing, Germany²²⁴. In 2013 they signed a partnership agreement with PHA plastic developer Newlight Technologies to further expand sales.
- **Bio-on**^{225,226}: Uses mainly beet and cane sub-products and waste in Italy to produce PHAs (MINERV-PHA) at the lab, pilot scale and pre-industrial scale (in collaboration with Co.Pro.B., an Italian sugar refinery). The fermentation process does not involve chemical solvents, and the bacteria used are not genetically modified. MINERV-PHA is certified as 100% biodegradable in water by Vincotte in 2008 and certified as 100% bio-based by the US Department of Agriculture in 2014 through its BioPreferred programme. Bio-on works with engineering companies to offer turnkey solutions: partnering with Techint engineering in 2012 with the intention of constructing 5, 10, 20 ktpa PHA plants. In late 2014 Bio-on has, following a public listing, commenced selling the first licenses to build the first pre-industrial plants around Europe.
- **KNN**²²⁷: In Groningen, Netherlands, and Anoxkaldnes in Lund, Sweden, have partnered for the production of PHA resin from industrial & municipal wastewater – it is not clear yet whether this will be via the sugar platform (via paper & pulp starches), or oil based
- **PHBottle**²²⁸: FP7 EU Project which aims to produce new packaging for fruit juices which is biodegradable and has antioxidant properties. Waste water from the fruit juice industry (over

²¹⁷ Chen G.Q. (ed.) (2009) "Plastics from bacteria: Natural functions and applications", Microbiology Monographs 14(1): 17-36.

²¹⁸ <http://bit.ly/1u71Qwa>

²¹⁹ [http://www.plastemart.com/Plastic-Technical-Article.asp?LiteratureID=2072&Paper=global-polypropylene-PP-market-expected-to-cross-US\\$124-billion-in-2019](http://www.plastemart.com/Plastic-Technical-Article.asp?LiteratureID=2072&Paper=global-polypropylene-PP-market-expected-to-cross-US$124-billion-in-2019)

²²⁰ <http://www.prnewswire.com/news-releases/global-polypropylene-market-is-expected-to-reach-usd-12401-billion-in-2019-transparency-market-research-247241851.html>

²²¹ <http://www.groenegrondstoffen.nl/downloads/Boekjes/16GreenBuildingblocks.pdf>

²²² Personal communication with Bio-on

²²³ <http://www.biomer.de/IndexE.html>

²²⁴ <http://greenchemicalsblog.com/2013/03/12/newlight-biomer-on-pha-deal/>

²²⁵ <http://www.bio-on.it/index.php?lin=inglese>

²²⁶ Personal communication with Bio-on

²²⁷ <http://www.themoldingblog.com/2013/03/13/knn-anoxkaldnes-move-closer-to-pha-plant-in-the-netherlands/>

²²⁸ <http://www.phbottle.eu/socios.htm>

34,200m gallons/year) containing fermentable sugars will be used to produce PHB, which will then be combined with cellulose fibres to improve the properties of PHB.

Rest of the world

- **Metabolix:** The key player in the USA, who did have a 50 ktpa plant in Iowa, USA as part of a joint venture with ADM for the production of Mirel (PHB). However, ADM pulled out of the JV in January 2012, citing lack of adequate sales and low market demand, and manufacture at the plant stopped. Metabolix was looking to develop a 10 ktpa PHA manufacturing facility in the USA²²⁹, however is now focusing on raising capital for a 2.5-5 ktpa plant by 2015²³⁰. It is also set to produce Mirel at Antibioticos SA in Leon, Spain but when production will begin is as yet unclear²³¹. Meanwhile, they have partnered with the Chinese company Tianjin Green Bio who are producing PHB under the name SoGreen²³² at a 10 ktpa plant in Tianjin, China.

Also in China, Yikeman in Shandong have a 3 ktpa PHB plant and TianAn Biopolymer Co in Zhejiang have a 2 ktpa PHBV plant. There are also a handful of other pilot plants in China. Kaneka Corp has a test production facility in Singapore that is capable of producing 1 ktpa and it plans to expand production to 10-20 ktpa over several years and begin commercial operations. PHB Industrial in Brazil, has a pilot plant producing 50-60 tpa of their PHB material, and expect to produce 4 ktpa from their commercial plant which is still under development²³³.

Value proposition

The production cost of PHA products has steadily decreasing over time and expected to decrease further still through the use of cheaper feedstocks. However, the production of PHA from purified substrates such as glucose and sucrose is considered largely optimised and 50% of the production cost is made up of the feedstock cost. Therefore, the ability to switch to cheaper feedstocks, such as molasses, starch, whey, lignocellulosic sugars and glycerol would be a major breakthrough in cost reduction. For example, when produced at scale (e.g. 100 ktpa), costs are expected to fall from 4,910 \$/tonne to 3,720 \$/tonne if hydrolysed corn starch is used as the carbon source instead of glucose (as corn starch is less than half the price of glucose)²³⁴. Furthermore, embedding PHB production into a sugar and ethanol mill also has the potential to significantly reduce PHB production cost²³⁵. This is because the energy required for production can come from burning the bagasse by-product on site, the feedstock for the PHB production (the sugarcane) is also readily available on site and the solvent required for extracting the PHB (medium chain iso-pentanol) is also produced on site in the ethanol production process²³⁶. However, not all actors (e.g. Bio-on) base their purification phase on organic solvents.

The relative GHG emission savings of PHAs compared to fossil counterparts is estimated to be around 20% when using starch feedstocks, rising to 60% in the future²³⁷. When using sugarcane, current savings were

²²⁹ <http://greenchemicalsblog.com/2013/08/01/metabolix-expands-collaboration-with-samsung-fine-chemicals/>

²³⁰ <http://www.kcpk.nl/algemeen/bijeenkomsten/presentaties/20140508-jan-ravenstijn-pha-is-it-here-to-stay>

²³¹ <http://ir.metabolix.com/releasedetail.cfm?ReleaseID=695943>

²³² [http://www.tjgreenbio.com/en/Product.aspx?cid=50&title=Resin Material](http://www.tjgreenbio.com/en/Product.aspx?cid=50&title=Resin+Material)

²³³ http://www.biocycle.com.br/imprensa_ing_02.htm

²³⁴ <http://bit.ly/1u71Qwa>

²³⁵ <http://bit.ly/1u71Qwa>

²³⁶ <http://bit.ly/1u71Qwa>

²³⁷ Hermann, B. G., Blok, K., and Patel, M. K. (2007), "Producing bio-based bulk chemicals using industrial biotechnology saves energy and combats climate change", *Environmental Science and Technology* 41(1):7915-7921.

higher at 80%, rising to over 100% in the future²³⁸ and PHAs from lignocellulosic feedstocks in the future were estimated result in 90% savings in GHG emissions. Kim and Dale estimated in 2008²³⁹ that the cradle-to-gate production of PHB from corn would result in GHG savings equivalent to 2.3 kg CO₂eq/kg PHB. It should be noted that because this is a cradle-gate assessment, it does not include further processing into products and the in-use and disposal phases of the material. Integrating production into existing sugar or ethanol mills will not only help improve the economic case but also have a beneficial impact on reducing GHG emissions associated with the process.

However, the primary value proposition of PHAs are their biodegradability under variable conditions, and being 100% bio-derived (both feedstock and process)²⁴⁰. PHB has a good resistance to moisture, good aroma barrier properties, can form a clear film, and has a melting point over 130°C. Furthermore, PHAs can also be used in thinner mouldings and have faster injection moulding cycles. Just as with traditional commercial grades of plastic, PHA can also be developed using various formulations, which differ both in mechanical and aesthetic properties, and also industrial processability – there is a large design space that allows similar properties to e.g. PP and PE to be obtained. A key advantage of PHA polymers is that they may be processed in existing petrochemical plastic processing plants (in injection moulding, extrusion, blowing, and calendaring processes), and do not require structural modifications or alterations to the plant²⁴¹. PHAs therefore have potential to be used in almost all aspects of the conventional plastic industry, if the cost barrier can be overcome²⁴².

Outlook

The large range of applications for PHAs and PHA blends and the fact that they are fully biodegradable have made this material an attractive proposition for decades now. However, the persistently high cost associated with its production has caused some high profile companies to renege on plans for its mass production in recent years, or cancel existing projects. The integration of its production in Brazilian sugar mills holds perhaps the best prospects for achieving the scales of cost reductions that are needed to start producing this product competitively and at scale. Blending with other lower cost bioplastics, such as PLA, also appears to be an attractive approach for food packaging for example.

The markets for fossil based PP is expected to reach 62.4 million tonnes by 2020, driven by large growth in demand in Asia Pacific, the Middle East and Africa²⁴³. Production of PE already stands at 88 million tonnes. Therefore, the markets for PHA are potentially equally large, but in the short term, whilst the cost of production remains significantly higher, the PHA market will be more focused on niche high value markets (e.g. medical sutures). In general, Europe and Asia are the major markets for biodegradable polymers. There are several factors that drive the development of the biodegradable polymers, including legislation adopted in favour of biodegradable products, the price of fossil feedstocks such as oil and gas, CO₂ and GHG emissions reduction targets and the urgent need to reduce the massive volumes of plastic waste in the environment.

²³⁸ Savings of over 100% are possible because of the use of co-products for energy production

²³⁹ Kim, S. and Dale, B.E. (2008), "Energy and greenhouse gas profiles of polyhydroxybutyrates derived from corn grain: A life cycle perspective", *Environmental Science and Technology* 42(20):7690-7695.

²⁴⁰ <http://www.kcpk.nl/algemeen/bijeenkomsten/presentaties/20140508-jan-ravenstijn-pha-is-it-here-to-stay>

²⁴¹ Personal communication with Bio-on

²⁴² Chen G.Q. (ed.) (2009) "Plastics from bacteria: Natural functions and applications", *Microbiology Monographs* 14(1): 17-36

²⁴³ <http://www.plasticsnews.com/article/20130909/NEWS/130909948/global-pp-market-to-reach-62-4-million-metric-tons#>

Whilst there are some larger plants in the planning stages, there does not appear to be huge momentum behind PHA at present. Its high cost relative to its fossil alternative, and the fact that other bioplastics with similar green credentials (albeit without the same range of properties of PHAs) are available at a cheaper price, means that it is not currently an overly attractive option in the short term, despite its large potential. Optimistic projections, based on a leap in technology and market uptake, estimate a CAGR of 41% by 2020 for PHA²⁴⁴.

Nevertheless, it is important to remember that time-to-market and profitability for oil-based plastics has previously taken 20+ years therefore market acceptance and volume growth for PHAs will likely take as much time as for any other new polymer²⁴⁵, and be further driven by the steady replacement of fossil-based plastics with bio-based alternatives such as PHB. Bio-on expects that PHA biopolymers will initially replace niche plastics with low production volumes and high value-add created by customised products for select clientele. PHA will be initially used to operate mainly in the areas of biomedical, automotive, design and packaging for the replacement of high-tech polymer whose market value currently stands between 12,000-25,000 \$/tonne.

²⁴⁴ Personal communication with Bio-on

²⁴⁵ <http://www.kcpk.nl/algemeen/bijeenkomsten/presentaties/20140508-jan-ravenstijn-pha-is-it-here-to-stay>

5.9. Polyethylene (PE)

Descriptions and markets

Polyethylene (PE) is the most widely manufactured polymer globally. Its primary use is in packaging, for example plastic bags, plastic films, geo-membranes, and containers including bottles, tubes. There are many different types and grades of PE, each of which has their own unique characteristics and applications.

PE is usually made by dehydrating ethanol to ethylene and subsequently polymerising the ethylene. PE is classified into several different categories based mostly on its density and branching. Its mechanical properties depend significantly on variables such as the extent and type of branching, the crystal structure and the molecular weight. The main types of PE are high density PE (HDPE), low density PE (LDPE) and linear low density PE (LLDPE). The latter is developed by copolymerising ethylene (C₂) with longer polymers such as butylene (C₄), hexene (C₆) or octene (C₈)²⁴⁶.

Fossil ethylene is derived from either modifying natural gas (a methane, ethane, propane mix) or from the catalytic cracking of crude oil²⁴⁷. PE from renewable raw materials (bio-based PE) can be made by dehydrating bio-ethanol to ethylene, and subsequently polymerising the ethylene²⁴⁸. It could also possibly be produced using lignocellulosic material (see Figure 23) though it is at present only produced using food crops²⁴⁹, e.g. sugar cane, sugar beet, corn, wheat.



Figure 23: Polyethylene production from lignocellulosic material

Fossil PE is the most commonly used plastic in the world, with a production volume of 88 million tonnes²⁵⁰ and a market share of nearly 30% of the total plastics market²⁵¹. The production capacity of bio-based PE is about 200 ktonnes²⁵². As a comparison, polyethylene terephthalate (PET) has a global production of 46 million tonnes²⁵³, with around 540 ktonnes currently bio-based²⁵⁴.

Actors

Bio-based PE has been in the market, and produced at commercial scale, for several years. There are currently no commercial scale plants in Europe, and Braskem is the main commercial scale producer worldwide accounting for 100% of global production capacity in 2013.

- **Braskem:** Has been producing high-density polyethylene (HDPE) made from sugarcane on an industrial scale since September 2010²⁵⁵, under the “i’m green”™ trademark. At the beginning of 2014 they announced the diversification of their resin portfolio with plans to produce 30 ktpa of bio-based low-

²⁴⁶ <http://nzic.org.nz/ChemProcesses/polymers/10J.pdf>

²⁴⁷ <http://nzic.org.nz/ChemProcesses/polymers/10J.pdf>

²⁴⁸ <http://www.braskem.com.br/site.aspx/green-products-USA>

²⁴⁹ <http://sperecycling.org/sites/sperecycling.org/files/papers/GPEC2013/l2peoples.pdf>

²⁵⁰ <http://www.groenegrondstoffen.nl/downloads/Boekjes/16GreenBuildingblocks.pdf>

²⁵¹ <http://www.groenegrondstoffen.nl/downloads/Boekjes/16GreenBuildingblocks.pdf>

²⁵² http://en.european-bioplastics.org/wp-content/uploads/2013/publications/EuBP_FS_Rigid%20Packaing_March2013.pdf

²⁵³ <http://www.groenegrondstoffen.nl/downloads/Boekjes/16GreenBuildingblocks.pdf>

²⁵⁴ http://www.corbion.com/media/203221/eubp_factsfigures_bioplastics_2013.pdf

²⁵⁵ <http://nzic.org.nz/ChemProcesses/polymers/10J.pdf>

density polyethylene (LDPE) annually²⁵⁶. Braskem are the first commercial producer of ethylene from bioethanol, utilising Brazil's traditional strengths in producing large volumes of low cost sugarcane ethanol for transport²⁵⁷. The ethylene produced is processed directly to PE²⁵⁸. Annual polyethylene production capacity is up to 200 ktpa^{259,260}. Braskem has also a number of partnerships with other industry actors, including Toyota Tsusho, who distribute their products in the Asia-Oceania region²⁶¹, and Tetra Pak²⁶², Nestlé²⁶³ and Johnson & Johnson²⁶⁴ which use its PE in their products/packaging.

- **Dow Chemical:** In 2007 Dow and Mitsui announced the formation of a 50-50 joint venture to build and co-own a 240ktpa ethanol plant at Dow's existing sugarcane operation at Santa Vitória, Brazil⁴. The second phase of the project, which was to include a 350 ktpa bio-polyethylene production plant on site, has been put on hold²⁶⁵.

Value proposition

Polyethylene is the most widely used type of plastic in the world, especially by the automotive industry and manufacturers of cosmetics, packaging, toys, personal hygiene and cleaning products.

The majority of bio-based rigid packaging products are made of bio-based non-biodegradable PE and PET. As a drop-in equivalent, bio-based PE has an identical chemical structure to fossil PE and may be used in the same applications. Although not biodegradable, bio-based PE can be easily recycled and can thus be included in the current waste separation process, and processed into new bio-based PE products using conventional technologies without requiring additional investments²⁶⁶.

Bio-based PE is currently sold at 30-60% above fossil PE, although other sources suggest a range of 15-50% higher^{267,268}. However, there is a degree of willingness of customers to pay these extra costs as the material is bio-based and more sustainable^{269,270}. It is anticipated that as production volumes increase the price differential will decrease²⁷¹. While specific bio-based PE production costs are not available publically, the cost of bio-based PE is closely linked to the production costs of bioethanol and biomass feedstock prices. In India and Brazil, where ethanol feedstocks (typically sugarcane) are relatively inexpensive and easily accessible, bio-ethylene (the bio-based PE building block) production costs are closer to fossil ones. In Brazil and India they are typically 1,200 \$/tonne bio-ethylene, and in China (using sweet sorghum feedstocks) are around 1,700 \$/tonne. In the United States, bio-ethylene costs (from corn) are reported at about 2,000 \$/tonne, and in Europe (from sugar beet) around 2,600 \$/tonne. Lignocellulose-based bio-ethylene

²⁵⁶ <http://en.european-bioplastics.org/blog/2014/02/11/material-innovations-biobased-low-density-polyethylene/>

²⁵⁷ http://www.irena.org/DocumentDownloads/Publications/IRENA-ETSAP%20Tech%20Brief%2013%20Production_of_Bio-ethylene.pdf

²⁵⁸ <http://sperecycling.org/sites/sperecycling.org/files/papers/GPEC2013/l2peoples.pdf>

²⁵⁹ <http://www.braskem.com/site.aspx/Im-greenTM-Polyethylene>

²⁶⁰ <http://green-polyethylene.com/whats.html>

²⁶¹ <http://green-polyethylene.com/whats.html>

²⁶² <http://www.plasticsnews.com/article/20130626/NEWS/130629946/tetra-pak-using-bio-based-polyethylene>

²⁶³ <http://www.tetrapak.com/about-tetra-pak/press-room/news/cap-renewablerawmaterial>

²⁶⁴ <http://www.fastcompany.com/most-innovative-companies/2014/braskem>

²⁶⁵ <http://www.biofuelsdigest.com/bdigest/2013/01/14/dow-and-mitsui-postpone-plans-for-green-plastic-but-still-ok-for-ethanol/>

²⁶⁶ <http://nzic.org.nz/ChemProcesses/polymers/10J.pdf>

²⁶⁷ <http://polymerinnovationblog.com/bio-polyethylene-drop-in-replacement/>

²⁶⁸ <http://ivem.eldoc.ub.rug.nl/ivempubs/dvrappp/EES-2012/EES-2012-128T/>

²⁶⁹ http://www.irena.org/DocumentDownloads/Publications/IRENA-ETSAP%20Tech%20Brief%2013%20Production_of_Bio-ethylene.pdf

²⁷⁰ <http://www.groenegrondstoffen.nl/downloads/Boekjes/16GreenBuildingblocks.pdf>

²⁷¹ <http://ivem.eldoc.ub.rug.nl/ivempubs/dvrappp/EES-2012/EES-2012-128T/>

²⁷¹ <http://polymerinnovationblog.com/bio-polyethylene-drop-in-replacement/>

²⁷¹ <http://ivem.eldoc.ub.rug.nl/ivempubs/dvrappp/EES-2012/EES-2012-128T/>

production is estimated at 1,900-2,000 \$/tonne in the US²⁷². Bio-ethylene prices are important as the final polymerisation step is a small relatively part of the PE production cost.

Bio-based PE shows a considerable reduction in GHG emissions and energy use compared to the fossil equivalents. The current production of bio-PE from sugarcane realises GHG emissions savings of more than 50%²⁷³. According to a study undertaken by Braskem, 1 kg of Green PE captures and stores about 2.15 kg of CO₂ while 1 kg of petrochemical PE releases almost 2 kg of CO₂. The gross fossil energy use of bio-based PE is reduced to under 20 MJ/kg PE, while the fossil equivalent is over 80 MJ/kg PE^{274,275}.

An early switch to renewable sources is important to the plastics industry to reduce oil dependency and GHG emissions. Major packaging producers and A-brands in food, drinks and cosmetics have already introduced bio-based PE in their packaging products (examples include Tetra Pak, Danone with Actimel, and Proctor and Gamble with Pantene)²⁷⁶.

Outlook/prospects

The global production capacity of bio-based PE is estimated to be able to reach 840 ktonnes by 2020²⁷⁷. With the technology commercialised (at TRL8-9), the real barrier to the bio-based PE market expanding is the price difference between fossil and bio-based. This is partially due to externalisation of environmental costs for fossil products²⁷⁸, and internalising these costs (for example via green VAT or a carbon tax)²⁷⁹ could reduce the price difference with fossil PE and make bio-based PE a more competitive product. Further incentive, in the form of volatile crude oil prices together with limited supply, had opened a market gap for bio-based chemicals at large including bio-based PE. However, it should be noted that recent significant decreases in oil prices may provide an unexpected challenge.

Bio-based PE has so far been successful only in Brazil, due to the presence of large quantities of low cost feedstock (with Brazil the leading producer of sugar cane ethanol globally).

The improved GHG and fossil energy use performance of bio-based PE, together with increasing focus on sustainability and more stringent environmental regulations and targets, is anticipated to drive demand for bio-based PE. However, in addition to cost competitiveness, there are also uncertainties which may hamper bio-based PE deployment. These include feedstock availability concerns (where raw materials such as sugarcane are also widely used in other industries), and competition with other competing bio-based packaging polymers such as PET, PLA and PEF²⁸⁰.

²⁷² http://www.irena.org/DocumentDownloads/Publications/IRENA-ETSAP%20Tech%20Brief%2013%20Production_of_Bio-ethylene.pdf

²⁷³ http://ivem.eldoc.ub.rug.nl/FILES/ivempubs/dvrapp/EES-2012/EES-2012-128T/EES-2012-128T_ToonHaer.pdf

²⁷⁴ <http://ciber.gatech.edu/Braskem.pdf>

²⁷⁵ <http://www.braskem.com.br/Portal/Principal/Arquivos/ModuloHTML/Documentos/1204/20131206-enviro-assessment-summary-report-final.pdf>

²⁷⁶ <http://www.groenegrondstoffen.nl/downloads/Boekjes/16GreenBuildingblocks.pdf>

²⁷⁷ Nova Institute (2013) "Market Developments of and Opportunities for biobased products and chemicals"

²⁷⁸ http://ivem.eldoc.ub.rug.nl/FILES/ivempubs/dvrapp/EES-2012/EES-2012-128T/EES-2012-128T_ToonHaer.pdf

²⁷⁹ http://www.irena.org/DocumentDownloads/Publications/IRENA-ETSAP%20Tech%20Brief%2013%20Production_of_Bio-ethylene.pdf

²⁸⁰ <http://www.grandviewresearch.com/industry-analysis/bio-based-polyethylene-pe-market>

5.10. Polylactic acid

Descriptions and markets

Polylactic acid (PLA), or polylactide, is a thermoplastic polyester, suitable for packaging materials, insulation foam, automotive parts, and fibres (textile and non-woven). It is a fully bio-based plastic, derived from corn starch (in the US), tapioca roots, chips or starch (in Asia) or sugarcane and sugar beets (in the rest of the world). PLA is also biodegradable/compostable under certain circumstances.

Figure 24 illustrates the process chain for PLA production. Lactic acid can be produced via fermentation or chemical synthesis. Industrial lactic acid production utilises the lactic fermentation process rather than chemical synthesis. This is because although synthetic routes produce a high quality product, they use hazardous raw materials (hydrogen cyanide, acetaldehyde), have high energy intensity due to triple distillation²⁸¹, cannot only make the desired L-lactic acid stereoisomer, and overall suffer high manufacturing costs²⁸².

In general, pure L-Lactic acid is used for to produce PLA²⁸³. To produce PLA, there are 3 primary polymerisation routes: direct condensation polymerisation, direct polycondensation in an azeotropic solution, and polymerisation through lactide formation – the current industrial-scale PLA production method. Lactide purification is done via high temperature vacuum-distillation, after which high molecular weight PLA with controlled purity is produced via ring-opening polymerisation. Other PLA methods cannot achieve the same high molecular weight and purity²⁸⁴.

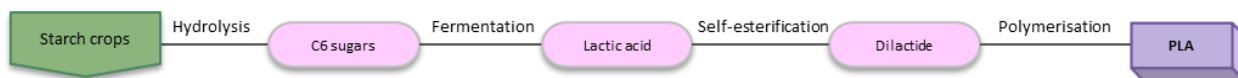

Figure 24: Production pathway for PLA

The global demand for lactic acid (including PLA) is estimated at 472 ktonnes, with revenues of around \$685m, based on market prices for bio-lactic acid of 1,300 – 1,600 \$/tonne²⁸⁵. Approximately 45% of lactic acid is used for industrial applications (including lactic acid for PLA), with the more conventional food additive, pharmaceutical and cosmetic markets demanding around 260 ktpa²⁸⁶. Global production capacity is estimated to be around 750 ktpa, with a strong presence in China.

In 2014, global production of PLA was estimated as being around 120 ktonnes, with estimated revenues of \$252m, based on a current price of \$ 2,000-2,200/tonne^{287,288,289}. The market price for PLA varies by region: US prices have in the recent past been 1,800 - 2,870 \$/tonne^{290,291}, whereas Chinese prices are around

²⁸¹ Lancaster, M., 2010, Green chemistry: An introductory text, 2nd edn, The Royal Society of Chemistry, Cambridge.

²⁸² Datta, R. and Henry, M. (2006), "Lactic acid: recent advances in products, processes and technologies - a review", Journal of Chemical Technology and Biotechnology 81(7): 1119-1129.

²⁸³ Mehta et al. (2005), "Synthesis of poly(lactic acid): A review", Journal of Macromolecular Science, Part C: Polymer Reviews 45(4): 325-349.

²⁸⁴ Jamshidian et al. (2010), "Poly-lactic acid: Production, applications, nanocomposites, and release studies", Comprehensive Reviews in Food Science and Food Safety 9(5): 552-571.

²⁸⁵ http://www.nnfcc.co.uk/publications/nnfcc-renewable-chemicals-factsheet-lactic-acid/at_download/file

²⁸⁶ <http://cdn.intechopen.com/pdfs-wm/42322.pdf>

²⁸⁷ Personal communication with Corbion Purac

²⁸⁸ Tecnon OrbiChem (31st July 2014) Chemical Business Focus, issue number 011

²⁸⁹ <http://cdn.intechopen.com/pdfs-wm/42322.pdf>

²⁹⁰ <http://www.funmat.fi/SABmeeting2013/42-Inkinen.pdf>

²⁹¹ <http://icoci.org/index.php/joc/article/viewFile/116/107>

3,500 \$/tonne (due to much smaller PLA facilities)^{292,293}. Global PLA production capacity stands at around 200 ktonnes²⁹⁴, although with a number of medium sized plants due to come online soon. PLA is primarily used for packaging applications, accounting for around 60% of its total market.

The PLA market is expanding, and although the downstream processing has improved substantially over recent years which has served to lower the price, it is still more expensive than fossil alternatives that serve similar markets. Addressable markets include:

- Polystyrene (PS) which in 2012 was estimated at 10.5 million tonnes with a market value of \$22 billion (\$2,100/tonne)²⁹⁵;
- Polypropylene (PP), which in 2011 was estimated at 42 million tonnes with a market value of \$77 billion (\$1,830/tonne)^{296,297} in 2012; and
- Polyethylene terephthalate (PET), which in 2013 was estimated at 20 million tonnes with a market value of \$31 billion (\$1,500/tonne)²⁹⁸.

These fossil-derived plastics prices are however likely to have fallen recently with lower crude oil prices in late 2014, making the economic competitiveness of PLA more challenging.

Actors

The PLA market is consolidated in nature, with a few large industry participants. The primary European actors, producing both PLA and lactic acid, are discussed below, with other global players briefly mentioned. The largest global commercial producer of PLA is USA-based NatureWorks, while the largest global lactic acid producer is Corbion Purac.

European PLA producers

- **Futero**²⁹⁹: A joint venture between Galactic and Total Petrochemicals, Futero has been operating a 1.5 ktpa demonstration plant in Escanaffles, Belgium since 2010 to produce various PLAs (including PLLA, PDLA and copolymer of L and D lactide). Funding is through the Walloon region's Marshall Plan.
- **Pyramid Bioplastics**: A joint venture between Pyramid Technologies and German Bioplastics to build a PLA plant in Guben (60 ktpa). The plant technology was provided by Uhde Inventa-Fischer. The plant was due to begin operation in 2012, but current status is unknown.
- **Synbra Technology**^{300, 301}: Jointly developed, with Sulzer Chemtech and Corbion Purac, a new, cost-effective polymerisation process to produce high-quality PLA from a biorenewable resource. Synbra have been using this technology to produce 5 ktpa PLA resin in a plant in the Netherlands since 2011. Sulzer also operates a 1 ktpa PLA pilot production plant in Switzerland. Synbra also uses its

²⁹² <http://www.icis.com/blogs/green-chemicals/2012/03/increasing-bioplactic-capacity/>

²⁹³ Tecnon OrbiChem (31st July 2014) Chemical Business Focus, issue number 011

²⁹⁴ Tecnon OrbiChem (31st July 2014) Chemical Business Focus, issue number 011

²⁹⁵ <http://westernplastics.org/wp-content/uploads/2014/01/Joel-Morales-Presentation.pdf>

²⁹⁶ [http://www.plastemart.com/Plastic-Technical-Article.asp?LiteratureID=2072&Paper=global-polypropylene-PP-market-expected-to-cross-US\\$124-billion-in-2019](http://www.plastemart.com/Plastic-Technical-Article.asp?LiteratureID=2072&Paper=global-polypropylene-PP-market-expected-to-cross-US$124-billion-in-2019)

²⁹⁷ <http://www.prnewswire.com/news-releases/global-polypropylene-market-is-expected-to-reach-usd-12401-billion-in-2019-transparency-market-research-247241851.html>

²⁹⁸ <http://www.biofuelsdigest.com/bdigest/2014/06/02/all-renewable-plastic-bottles-creep-closer-gevo-shipping-renewable-px-to-toray/>

²⁹⁹ <http://www.futero.com/technology.html>

³⁰⁰ <http://www.futero.com/technology.html>

³⁰¹ http://www.sulzer.com/en/-/media/Documents/Cross_Division/STR/2012/STR_2012_1_13_14_Wintergerste_e.pdf

own PLA production capacity to produce expanded PLA foam, a biodegradable alternative to expanded polystyrene (EPS) foam.

- **Uhde Inventa Fischer**^{302, 303}: Part of ThyssenKrupp Industrial Solutions AG. They constructed a pilot plant in 2010 to produce 0.5 ktpa of PLA in Guben, Germany. It is now able to license its PLA production technology to plants with capacity of up to 60 ktpa. Together with Myriant, in 2013 ThyssenKrupp opened a multi-purpose fermentation pilot plant in Germany to produce 1 ktpa biochemicals annually, including lactic acid.
- **Cellulac**³⁰⁴: In 2013 announced plans to convert a brewery in Ireland into a lactic acid and PLA plant using 2G feedstocks. Initial capacity will be 20 ktpa, ramping up later to 100 ktpa. They currently have a pilot plant in Postdam, Germany.
- **[Corbion Purac]**³⁰⁵: Announced in October 2014 that it will integrate downstream by becoming a PLA producer, if customers will commit to buying at least one third of the output of a planned 75 ktpa PLA plant in Thailand. Corbion Purac has also announced a collaboration with Japanese Toyobo to produce Vyloecol, an amorphous PLA product for coating and adhesive applications, for the European market³⁰⁶. A JV with Supla Co. Ltd will see Supla setting up a 10 ktpa PLA polymerisation factory in China, which will use Corbion Purac's lactides³⁰⁷.

European lactic acid producers

- **Corbion Purac**³⁰⁸: Produces lactic acid, lactic acid derivatives and lactides (including lactide resins for high performance PLA bioplastics); they are well known for their expertise in fermentation of L- and D-lactic acid and subsequent conversion into high purity and 100% biobased L- and D-Lactides. They operate 5 production plants globally in: the USA, the Netherlands, Spain, Brazil and Thailand (which at 100 ktpa is their largest plant). In Thailand, Corbion Purac also operates a 75 ktpa lactide plant. Corbion Purac also operates a demo plant for succinic acid in Spain together with BASF through the Succinity GmbH JV.
- **Galactic**³⁰⁹: Galactic produces lactic acid and lactides in manufacturing plants in Europe (30 ktpa), Asia and America (15 ktpa). Their major shareholder is Finasucre, one of the world's largest producers of sugar. In 2002 Galactic also formed a joint venture with BBKA Biochemical, B&G, in China (Bengbu) for the production of L (+) lactic acid with a capacity of 50 ktpa.
- **Direvo Industrial Biotechnology**³¹⁰: Recently completed laboratory testing of a new low cost production process for L-lactic acid.
- **Plaxica**³¹¹: UK-based demonstration plant; seeking potential licensees and partners.
- **Jungbunzlauer**³¹²: Known mainly for the production of citric acid and gluconic acid, with production plants in Austria, France, Germany and Canada. Since 2012 Jungbunzlauer has been operating a lactic acid plant from its production site in Marckolsheim, France. Capacity is undisclosed.

³⁰² <http://www.uhde-inventa-fischer.com/polylactic-acid/planeoc2ae-process/>

³⁰³ <http://en.european-bioplastics.org/blog/2013/09/09/thyssen-krupp-invests-into-production-processes-for-biodegradable-plastics/>

³⁰⁴ <http://cellulac.co.uk/en/aenean-nec-eros/cellulac-to-produce-up-to-100000-tonnes-of-lactic-acid-per-year/>

³⁰⁵ <http://www.corbion.com/>

³⁰⁶ <http://books.google.co.uk/books?id=ohpaDQZF5JcC&pg=PA30&lpg=PA30&dq=Pyramid+Bioplastics+PLA+plant&source=bl&ots=3fScYeGeE1&sig=WLDsmiYNGNdYjpRzviYR8SVDgRM&hl=en&sa=X&ei=MXQZVK-WO8mp7AbnlYGIcG&ved=0CEUQ6AEwBA#v=onepage&q=Pyramid%20Bioplastics%20PLA%20plant&f=false>

³⁰⁷ <http://www.plasticsnews.com/article/20141017/NEWS/141019943/corbion-purac-collaboration-taking-bioplastics-into-even-more-uses>

³⁰⁸ <http://www.corbion.com/>

³⁰⁹ <http://www.lactic.com/en-us/aboutus/ourhistory.aspx>

³¹⁰ http://www.direvo.com/fileadmin/user_upload/DIREVO-PressRelease_No6_2013.pdf

³¹¹ <http://www.plaxica.com/technology/technology-demonstration/>

Rest of the world

- **NatureWorks**³¹³: Originally a joint venture between Cargill and Dow Chemicals, Dow later sold their stake to Teijin, who then sold it back to Cargill. It is now owned by Cargill and PTT Global Chemical. They also formed a JV with BioAmber for a PLA/PBS composite. NatureWorks produce PLA resins under the Ingeo brand, and have a commercial production plant in Nebraska (150 ktpa). They are currently planning a new plant in Thailand, expected to come online in 2017, which is expected to be ~150 ktpa³¹⁴. In 2013, NatureWorks announced an agreement with Irish-based 3Dom Filament Limited, which will combine NatureWorks' Ingeo PLA resins with 3Dom's novel filament manufacturing processes for use in the 3D printing industry³¹⁵.

Other PLA producers include USA-based Heplom American Chronopol³¹⁶ (2ktpa demo plant), and Chinese Zhejiang Hisun Biomaterial³¹⁷ (5.5 ktpa to be expanded to 50 ktpa; using cassava instead of corn). Other lactic acid producers include Glycos Biotechnologies (~0.1 ktpa, USA)³¹⁸, Henan Jindan Lactic Acid Technology³¹⁹ (100 ktpa – the largest in Asia), Chongqing Bofei Biochemical Products³²⁰ (~75 ktpa, China), Unitika-Terramac (5 ktpa, Japan), Nantong Jiuding Biological Engineering (1 ktpa, China), Shanghai Tong-jie-liang Biomaterial (0.3 ktpa, China), Piaoan Group (10 ktpa in planning, China), Toray Industries (5 ktpa, South Korea), Teijin Limited (1.2 ktpa, Japan), Mitsui Chemical (Japan), and Purac-Toyobo (Japan)³²¹.

Value proposition

The production costs of PLA remain unconfirmed; however the use of lactic acid as a feedstock contributes 40-65% of the total production cost of PLA³²². The production process has favourable yields of up to 80% – better than bio-plastic equivalents such as bio-PP, bio-PET, and bio-PE³²³.

The value proposition of PLA is primarily attributed to its environmentally beneficial properties. PLA plastic is durable – offering a viable alternative to traditional thermoplastic products, and disposable – it is degradable and can be composted easily compared to petroleum-based equivalents, and it does not emit toxic gases on incineration. PLA production has multiple advantages, including the ability to recycle back to lactic acid via hydrolysis or alcoholysis and capability to produce hybrid paper-plastic packaging that is compostable³²⁴.

PLA offers a substantial reduction in GHG emissions and energy use compared to competing fossil equivalents such as polypropylene (PP), polystyrene (PS) and polyethylene terephthalate (PET). The current

³¹² <http://www.foodproductdesign.com/News/2012/01/Jungbunzlauer-Begins-Lactic-Acid-Production.aspx?topic=lactic-acid>

³¹³ <http://www.natureworkslc.com/News-and-Events/Press-Releases/2011/10-12-11-NatureWorks-attracts-PTT-Chemical-equity-investment>

³¹⁴ <http://www.gupta-verlag.com/general/news/industry/14880/THAILAND-NatureWorks-expects-2014-decision-on-Thai-Ingeo-biopolymer-facility>

³¹⁵ <http://www.natureworkslc.com/News-and-Events/Press-Releases/2013/12-10-13-NatureWorks-3DOM-collaborate-on-Ingeo-PLA-filament-for-3D-printing>

³¹⁶ <http://renewablechemicals.agra-net.com/2011/10/thai-ptt-acquires-50-stake-in-natureworks/>

³¹⁷ http://www.nova-institut.de/download/Investments_list

³¹⁸ <http://www.glycosbio.com/glycos-biotechnologies-announces-successful-production-of-biochemicals-in-pilot-plant-size-environment/>

³¹⁹ <http://jindanlactic.diytrade.com/>

³²⁰ <http://www.businesswire.com/news/home/20130905005691/en/Research-Markets-China-Lactic-Acid-Derivative-Industry#.VCmkFmddV1Y>

³²¹ <http://www.grandviewresearch.com/industry-analysis/lactic-acid-and-poly-lactic-acid-market>

³²² <http://icoci.org/index.php/joc/article/viewFile/116/107>

³²³ http://www.innovationtakesroot.com/~media/ITR2014/2014/presentations/plenary-wed/04_One-Decade-of-Progress_Verbruggen_pdf.pdf

³²⁴ Jamshidian et al. (2010), "Poly-lactic acid: Production, applications, nanocomposites, and release studies", *Comprehensive Reviews in Food Science and Food Safety* 9(5): 552-571.

production of PLA realises GHG emissions savings of between 30 – 70%, and this could be increased to as much as 80% as processing technologies improve^{325,326}.

- In 2007, GHG savings from PLA were estimated at 2.3 tCO₂/t-product and projected to increase to 3.3 tCO₂/t-product, which could result in potential annual savings of up to 36,500 ktCO₂/year^{327,328} if displacing the whole polystyrene market.
- In 2009, benchmarking on a polymer pellet basis, NatureWorks estimated the gross fossil energy use of their 1st generation PLA Ingeo (using dextrose from corn starch) was 42 MJ/kg polymer, with GHG emissions of 1.3 kgCO₂e/kg polymer³²⁹. Their next generation PLA shows GHG emissions of 0.5-0.74 kgCO₂e/kg polymer and fossil energy use of 40.2 MJ/kg polymer.

PLA emissions and fossil energy use are therefore significantly lower than fossil-based competitors such as PS (2.2 kgCO₂e/kg polymer), PP (1.63 – 1.86 kg CO₂e/kg polymer, 75.9 - 77.1 MJ/kg polymer), and PET (2.00 – 2.73 kgCO₂e/kg polymer, 69.0 - 70.2 MJ/kg polymer)^{330,331}. New generation PLAs, using crop residues and renewable energy, promise further reductions.

PLA manufacturing technology is mature; however the product itself suffers from performance drawbacks as compared to conventional plastics. For example, PLA typically has a high tensile strength, low toxicity and good appearance (glossy with high transparency), but suffers from brittleness, poor gas barrier performance and is susceptible to distortion at relatively low temperatures (i.e. lower heat resistance). However, PLA producers have been working to develop proprietary processes in order to improve these characteristics and PLA has been shown to have an adjustable set of physical properties. NatureWorks offers 21 grades of PLA resin, each with a different molecular weight and varying lactic acid co-monomer ratio, which have been customised to suit different production techniques and product requirements³³². Corbion Purac has recently developed a breakthrough stereochemically pure lactide monomer, which can be used in PLA homopolymers to produce polymer blends which show heat resistance properties similar to PP, PS & ABS type materials³³³.

In summary, PLA offers a strong environmental incentive for replacement of fossil equivalents. It has a lower carbon footprint and uses less energy, and offers improved end-of-life options because it is biodegradable and low in toxicity. It does have performance drawbacks, including low heat resistance and impact resistance, however these are improving rapidly as manufacturers customise the PLA resin grade to their production method and purpose. It is not yet available in high volumes, and has a slightly higher market price than fossil-based competitors, however there is a strong commercialisation drive which will increase economies of scale.

³²⁵ http://www.nnfcc.co.uk/publications/nnfcc-renewable-chemicals-factsheet-lactic-acid/at_download/file

³²⁶ <http://www.natureworksllc.com/the-ingeo-journey/Eco-Profile-and-LCA/Eco-Profile.aspx#GHG>

³²⁷ <http://www.ieabioenergy.com/wp-content/uploads/2013/10/Task-42-Biobased-Chemicals-value-added-products-from-biorefineries.pdf>

³²⁸ Hermann, B. G., Blok, K., and Patel, M. K. (2007), "Producing bio-based bulk chemicals using industrial biotechnology saves energy and combats climate change", *Environmental Science and Technology* 41(1): 7915-7921.

³²⁹ Vink et al. (2010), "The eco-profile for current Ingeo polylactide production", *Industrial Biotechnology* 6(4): 212-224.

³³⁰ <http://www.natureworksllc.com/the-ingeo-journey/Eco-Profile-and-LCA/Eco-Profile.aspx#GHG>

³³¹ <http://www.corbion.com/media/168367/cmd-2013-pla.pdf>

³³² http://www.innovationtakesroot.com/~media/ITR2014/2014/presentations/plenary-wed/04_One-Decade-of-Progress_Verbruggen_pdf.pdf

³³³ http://www.corbion.com/media/77166/corbionpurac_high_heat_pla_leaflet.pdf

Outlook

Estimates for the future development of the global PLA market vary quite widely, with either 950 ktpa produced by 2020³³⁴ (a CAGR of 40%), or more conservatively, only 600 ktpa by the year 2025 (a CAGR of 10%)³³⁵. At prices of \$2,100/tonne, the market would be valued at \$1.3 – 2.0 bn a year. Packaging is likely to remain the key application segment for PLA. Given Europe's strong drive towards bio-based packaging materials, it is anticipated that Europe will remain a regional leader until 2020³³⁶. The share of PLA in Europe's total biopolymer production is expected to be around 13% (216 ktonnes) in 2015.

Demand for more environmentally-friendly packaging products, and the use of PLA in starch-based plastics is expected to drive demand for PLA over the next few years. Further incentives include renewable energy targets and a shift to renewable feedstocks, and health concerns related to chemical toxicity. Previously high oil price rises and price volatility for complex hydrocarbons derived from crude oil³³⁷ has opened a market gap for bio-based chemicals. This may help to increase global PLA demand, and improve the price competitiveness.

³³⁴ http://www.bio-based.eu/market_study/media/files/13-07-24PRMarketStudy nova.pdf

³³⁵ <http://www.corbion.com/media/press-releases?newsId=1867550>

³³⁶ <http://www.grandviewresearch.com/industry-analysis/lactic-acid-and-poly-lactic-acid-market>

³³⁷ http://www.innovationtakesroot.com/~media/ITR2014/2014/presentations/plenary-wed/04_One-Decade-of-Progress_Verbruggen_pdf.pdf

5.11. Succinic acid

Description and markets

Succinic acid is a 4 carbon platform chemical that has a broad range of applications, from high-value niche applications such as personal care products and food additives (used in the food and beverage industry as an acidity regulator), to large volume applications such as bio-polymers (for example PBS), plasticizers, polyurethanes, resins and coatings.

Petrochemical succinic acid has predominantly been produced from butane through catalytic hydrogenation of maleic acid or maleic anhydride³³⁸. Bio-based succinic acid (BSA) is most commonly produced through low pH yeast or bacterial fermentation as shown in Figure 25. Other competing routes to produce succinic acid start from glycerol, whilst BDO can also be fermented directly.

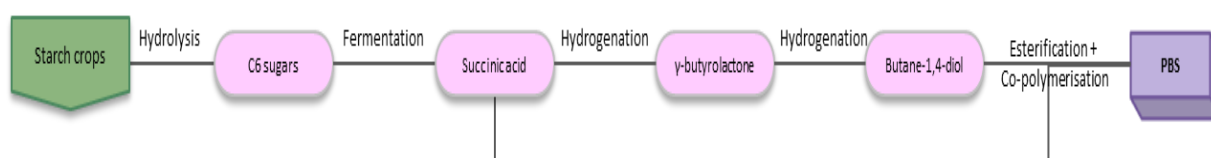

Figure 25: Production pathway for succinic acid, BDO, and PBS

In 2013, global production of bio-based succinic acid was 38 ktonnes at a total bio-based market value of \$108 million. Fossil-based succinic acid production was approximately 40 ktonnes with a market value of \$100 million³³⁹. Bio-based succinic acid has a current market price of approximately 2,860 \$/tonne, while the fossil-based equivalent is valued at around 2,500 \$/tonne³⁴⁰. At larger scale (typically 50 ktonnes), bio-succinic acid has the potential to be cheaper than fossil-derived succinic acid.

As a platform chemical, bio-based succinic acid has an estimated potential addressable market of \$7- 10 billion³⁴¹, including \$4 billion³⁴² from large volume industrial chemicals such as 1,4 butanediol (BDO), tetrahydrofurane (THF), and gammabutyrolactone (GBL). Another derivative of succinic acid is polybutylene succinate (PBS), a key polymer used in the production of bio-plastics. Bio-based BDO is currently selling at 3,000 \$/tonne with a market volume of 3 ktonnes, which, while more expensive than the fossil-based alternative, is expected to become increasingly competitive as it reaches economies of scale. Bio-based PBS has a current market price of approximately 4,500 \$/tonne, market volume of 5 - 6 ktonnes and a market value of around \$24 million³⁴³.

Actors

Unlike some sectors, there is intense competition within the bio-based succinic acid sector, with several EU and non-EU actors at similar levels of development.

³³⁸ Cok, B., Tsiropoulos, I., Roes, A.L., Patel, M.K. (2013), "Succinic acid production derived from carbohydrates: An energy and greenhouse gas assessment of a platform chemical toward a bio-based economy", *Biofuels, Bioproducts and Biorefining* 8(1): 16-29

³³⁹ http://www.bioconcept.eu/wp-content/uploads/BioConSepT_Market-potential-for-selected-platform-chemicals_report1.pdf

³⁴⁰ http://www.bioconcept.eu/wp-content/uploads/BioConSepT_Market-potential-for-selected-platform-chemicals_report1.pdf

³⁴¹ <http://www.bio-amber.com/products/en/products>

³⁴² <http://www.european-biotechnology-news.com/news/news/2012-03/evonik-and-bioamber-team-up.html>

³⁴³ Kabasci, S. (ed.) (2014), "Bio-based Plastics: Materials and applications", John Wiley & Sons, UK

Europe:

- **Reverdia:** JV between Roquette and DSM established in 2008. They started operating a 10ktpa plant in Cassano, Spinola in Italy in 2012. Reverdia is collaborating with players in the PBS, PU, plasticizers, resins and coatings applications including cooperating with Chinese companies active in the area of plasticizers either as a supplier of succinic acid or co-developer of various markets³⁴⁴. Next to production, Reverdia has also announced that it offers its Biosuccinium™ low-pH technology for licensing.
- **Succinity:** JV between Corbion Purac and BASF established in 2013 (with joint R&D since 2009). Headquartered in Dusseldorf, Germany, they started operating a 10ktpa plant in Montmelo, Spain in 2013. Succinity has plans for a second large-scale 50 ktpa facility, the final investment decision for which will be made following a successful market introduction of the Montmelo plant BSA³⁴⁵.

Rest of world:

- **BioAmber:** Canadian company who have run a 3ktpa demonstration plant in Pomacle, France since 2010. They are currently constructing a 30 ktpa plant (with 20 ktpa expansion plans to 50 ktpa total capacity) in Sarnia, Canada with JV partner Mitsui & Co. They are also planning a second plant in North America, producing 100 ktpa BDO and 70 ktpa succinic acid, to commence operation in 2017 or 2018³⁴⁶, with a third (200 ktpa) for startup in 2020³⁴⁷.
- **Myriant:** A US-based company operating a small production plant (1ktpa) in Leuna, Germany with ThyssenKrupp. Myriant also completed construction of the first commercial bio-succinic acid plant (14 ktpa) in Louisiana, North America in April 2013. A second plant, with 64 ktpa capacity, is being planned for start-up in 2015³⁴⁸.

A number of partnerships and joint ventures have developed in the bio-based succinic acid (and associated downstream) industries. BioAmber recently signed a 3-year exclusive supply contract with PTT-MCC Biochem, to supply 80% of their bio-succinic acid needs, for PBS production³⁴⁹. The partners also collaborate to test proprietary organisms in BioAmber's production facility in France to further lower production costs³⁵⁰. A further take-or-pay supply contract with Vinmar will see annual uptake of 210 ktpa when all three plants are operational³⁵¹. BioAmber has also teamed with NatureWorks to create Amberworks - making polylactic acid (PLA) and PBS composites. Both Showa Denko KK (Japan) and Uhde Inventa Fischer (Europe) make use of Myriant's bio-succinic acid for PBS production³⁵². Another partnership BioAmber is involved in is with Evonik on the production of BDO, THF and GBL³⁵³.

³⁴⁴ <http://www.reverdia.com/press-releases/reverdia-showcases-biosuccinium-100-bio-based-succinic-acid-underlines-importance-chinese-plastics-market/>

³⁴⁵ <http://www.succinity.com/news/140303.htm>

³⁴⁶ <http://www.bio-amber.com/bioamber/en/company>

³⁴⁷ <http://investor.bio-amber.com/2014-07-07-BioAmber-Signs-Take-or-Pay-Contract-For-Three-Bio-Succinic-Acid-Plants>

³⁴⁸ http://www.chemweek.com/lab/Industrial-biotechnology-Chemical-building-blocks-from-renewable-resources_54373.html

³⁴⁹ <http://greenchemicalsblog.com/2014/05/19/ptt-mcc-signs-bio-succinic-acid-contract-with-bioamber/>

³⁵⁰ http://www.chinabiobasedtech.com/_d276426225.htm

³⁵¹ <http://investor.bio-amber.com/2014-07-07-BioAmber-Signs-Take-or-Pay-Contract-For-Three-Bio-Succinic-Acid-Plants>

³⁵² <http://greenchemicalsblog.com/2012/10/05/to-succinity-and-beyond/>

³⁵³ <http://www.european-biotechnology-news.com/news/news/2012-03/evonik-and-bioamber-team-up.html>

Value proposition

The costs of production compared to petroleum-derived succinic acid have been equal as of 2013³⁵⁴ and petrochemical succinic acid is now mainly being used only in niche markets due to increasing production costs. BioAmber believes it can competitively produce bio-based succinic acid at a crude oil price above 35 \$/barrel and corn prices of 6.50 \$/bushel³⁵⁵. It is therefore expected that a less costly bio-based production of succinic acid will lead to stronger competitiveness and larger market demand³⁵⁶.

Furthermore, today's technology for the production of succinic acid from biomass can realise a significant reduction in GHG emissions compared to petrochemical equivalents. Succinity has reported 75% GHG savings compared to petrochemical succinic acid, while BioAmber has reported over 100% savings with petro-succinic acid emitting 7.1 kg CO₂e/kg compared to -0.18 kg CO₂e/kg for the bio-based production route on a cradle/field-to-gate basis. BioAmber's reported energy use for bio-based succinic acid is around 34.7 MJ/kg compared to the fossil-based 97.7 MJ/kg³⁵⁷. In a detailed footprint study researchers have recently shown that a low-pH yeast route to bio-based succinic acid has the lowest environmental impact in terms of energy use and carbon emissions³⁵⁸. This is the route Reverdia is using. The two largest factors affecting GHG savings are feedstock production and the carbon intensity of the electricity grid in which the production plant is located, especially if energy intense downstream processing has been applied (such as electrodyalisis of the succinate salt following fermentation)³⁵⁹.

The physical properties of bio-based succinic such as density, viscosity, molar volume and surface tension are identical to those of petro-based succinic acid and the chemical is therefore considered a drop-in with no additional investment required in new production equipment. The main value propositions offered by bio-based succinic acid are therefore price competitiveness, lower environmental impact and ease of production. Bio-based PBS is becoming steadily more cost-effective compared to its petrochemical counterpart, which is directly linked to recent cost reductions in bio-based succinic acid and BDO³⁶⁰. Further, bio-based succinic acid is also considered a near drop-in for fossil adipic acid in applications such as resins, plasticizers and polyester polyols for polyurethanes. It offers additional performance benefits compared to adipic acid, including improved hardness and flexibility of powder coatings, shorter drying times in alkyds and better chemical resistance in polyurethanes based systems.

Outlook

Several companies have aggressive growth plans in the coming years. BioAmber are currently building a commercial-scale plant in Sarnia, Canada with plans for two additional plants, which will create capacity of around 300 ktonnes by 2020. All of this production is already agreed for sale; BioAmber already have over 19 supply and distribution agreements excluding those with PTT-MCC BioChem and Vinmar³⁶¹. In their 2011 IPO filing Myriant stated plans to expanding operations with a 100 ktpa plant in Nanjing, China with China

³⁵⁴ http://www.bioconcept.eu/wp-content/uploads/BioConSepT_Market-potential-for-selected-platform-chemicals_report1.pdf 013, BioConSepT

³⁵⁵ http://www.chinabiobasedtech.com/_d276426225.htm

³⁵⁶ <http://www.groenegrondstoffen.nl/downloads/Boekjes/16GreenBuildingblocks.pdf>

³⁵⁷ http://www.succinity.com/biobased_succinic_acid/our_product/, http://www.bio-amber.com/bioamber/en/sustainability/life_cycle_analysis_lca (<http://archive.today/WgAeM>)

³⁵⁸ Cok, B., Tsiropoulos, I., Roes, A.L., Patel, M.K. (2013), "Succinic acid production derived from carbohydrates: An energy and greenhouse gas assessment of a platform chemical toward a bio-based economy", *Biofuels, Bioproducts and Biorefining* 8(1): 16-29

³⁵⁹ Cok, B., Tsiropoulos, I., Roes, A.L., Patel, M.K. (2013), "Succinic acid production derived from carbohydrates: An energy and greenhouse gas assessment of a platform chemical toward a bio-based economy", *Biofuels, Bioproducts and Biorefining* 8(1): 16-29

³⁶⁰ http://resource.co/article/Futurevision/Biopolymers_industry_hampered_production_costs-3680

³⁶¹ http://resource.co/article/Futurevision/Biopolymers_industry_hampered_production_costs-3680

National BlueStar, however the status of these plans is unconfirmed³⁶². They are also cooperating with Sojitz in Japan. These growth plans are likely tied to the expectation that bio-based succinic acid will open up new markets and applications, especially as a platform chemical for the production of BDO and PBS³⁶³. It is expected that the scale benefit and lower costs of raw materials for succinic acid will lead to considerably reduced production costs.

By 2015, up to two-thirds of succinic acid production is expected to be bio-based³⁶⁴. Continued collaborations, R&D and cost reduction are therefore likely to create a highly competitive market for bio-based succinic acid, BDO and PBS in the coming years.

By 2020 the bio-succinic acid market is projected to reach 600 ktonnes with annual revenues of \$539 million³⁶⁵, however this translates to an optimistic market price of under 1,000 \$/tonne, which seems somewhat unlikely given today's production costs³⁶⁶. The main market demands for bio-based succinic acid are expected from BDO and PBS:

- Volumes for bio-based PBS are expected to grow at 37% CAGR, reaching 82 ktonnes of succinic acid demand by 2020³⁶⁷;
- Bio-based BDO from succinic acid is expected to grow at a CAGR of up to 43%, reaching 316 ktonnes of succinic acid consumed by 2020³⁶⁸.

More conservative market estimates only state a total of 250 ktonnes of bio-based succinic acid by 2020³⁶⁹.

5.12. Summary

The ten case studies have been summarised in Table 6 below, to capture the most salient and interesting aspects of their particular development. This includes an overview of the actors, the key markets/applications and value proposition, their production cost and GHG emissions relative to fossil competitors, and the European outlook for each product.

³⁶² <http://www.icis.com/resources/news/2013/07/02/9684067/myriant-in-talks-to-build-bio-bdo-plant-in-asia-exec/>

³⁶³ <http://www.groenegrondstoffen.nl/downloads/Boekjes/16GreenBuildingblocks.pdf>

³⁶⁴ http://www.lifesciadvisors.com/clientinfo/bioamber/BioAmber__Initiation_Report_10-08-2013__clientinfo.pdf

³⁶⁵ http://www.bioconcept.eu/wp-content/uploads/BioConSepT_Market-potential-for-selected-platform-chemicals_report1.pdf

³⁶⁶ Personal communication with Reverdia and Corbion Purac

³⁶⁷ http://www.bioconcept.eu/wp-content/uploads/BioConSepT_Market-potential-for-selected-platform-chemicals_report1.pdf

³⁶⁸ http://www.bioconcept.eu/wp-content/uploads/BioConSepT_Market-potential-for-selected-platform-chemicals_report1.pdf

³⁶⁹ Nova Institute (2013) "Market Developments of and Opportunities for biobased products and chemicals"

Table 6: Summary of the case studies

Bio-based product	Actors	Key markets or applications and value proposition	Cost relative to fossil alternative	GHG saved vs. fossil alternative	European outlook
Acrylic acid	There are 2 key strategic partnerships of note. These are: BASF/Cargill/Novozymes (in the EU) and OPXBio/Dow (USA). Both focusing on the 3-HPA route.	Drop-in replacement for fossil acrylic acid. Widely used chemical intermediate. Key markets are in coatings, adhesives, diapers, fibres, textiles, resins, detergents, cleaners, elastomers, floor polishes and paints.	Bio-based processes may benefit from production costs 20 - 48% better than the petro-based acrylic acid process once commercialised	>70% GHG savings	Multiple highly ambitious plans, including in the EU, to commercialise technologies already proven at pilot scale, as soon as 2017. There has been collaboration between major players to fast track development of a number of different processes using different feedstocks.
Adipic acid (ADA)	EU players are Biochemtex and DSM, who have plans for commercial production in the future. Some US projects have reached pilot scale (Rennovia, Verdezyne).	Drop-in replacement for fossil adipic acid, meeting demand for nylon 6,6 for the automobile and electronic industries and for polyurethanes for the global footwear market.	Expected to be cost competitive with fossil. Some producers expecting significant savings based on lower capex and utilities	70-95% reduction in emissions, depending on N ₂ O intensity of the fossil counterfactual	Still at an early stage with no commercial production. EU is the 2nd largest consumer of ADA, which should act as a driver for its development. It is slightly lagging the US, who have more pilots.
1,4 – Butanediol (BDO)	Genomatica (USA) produces BDO directly via sugar fermentation. Several EU companies (BASF, Novamont, DSM, Biochemtex) producing BDO and PBT based on Genomatica's technology. JM-Davy are producing BDO from Myriant's succinic acid	Drop-in replacement for fossil BDO. BDO is used to make GBL and the important solvent THF. PBT can also be made by polymerising terephthalic acid and BDO, and has high tensile strength, tensile elasticity and heat resistance.	Production costs could be 15-30% lower than fossil BDO and competitive at an oil price of 45 \$/barrel and natural gas price of 3.5 \$/million BTU	70-117% reduction in GHG emissions relative to fossil BDO depending on the process and feedstock.	There is some activity in Europe, particularly through joint ventures which have resulted in the development of plants, and the expectation of further plants being developed by BASF and Novamont. Otherwise, EU activity is upstream (Chemtex), or downstream (DSM, JM-Davy)
Farnesene	Only one market player, US-based Amyris. There are no major European players.	Emollients already a key market as squalane derived from farnesene has excellent moisturising properties. There is also potential in the tyre industry due to superior physical properties compared with conventional alternatives. For fuels, the physical and performance properties are consistent with C15 iso-paraffin.	Already an attractive value proposition in emollients industry; close to market in tyre industry; production costs are high compared to diesel or jet.	Sugarcane-derived farnesene used as a diesel or jet fuel can result in an 80% reduction in GHG emissions compared with conventional fossil fuels.	Amyris has a range of markets into which it could expand and superior performance in many cases. As a building block, more applications could be found in the future. In the EU, the main opportunities seem to be through partnering with Amyris on specific applications, which a number of EU companies appear to be doing.
2,5 furandicarboxylic acid (FDCA)	Only a few companies actively involved, with the market led by Avantium in the EU (a spin-off from Shell). Corbion Purac, AVA Biochem and Novozymes also active in this space in Europe.	Can substitute for TPA in the production of polyesters giving rise instead to a new class of polyethylene furanoate (PEF) polymers. Applications likely to be in plastic drinks bottles (superior barrier properties compared to PET) but also as a platform chemical and in the production of novel solvents.	Current production costs are high since at small scale, so yet to be commercialised	45-68% reduction in emissions	Global production only 40 tonnes, so it is early days. However, activity seems to be focused in Europe, and Avantium have ambitious plans, having secured co-operation agreements with a number of customers for its PEF bottles. Also looking to sell licences to build or retrofit plants each producing 300-500ktpa FDCA.

Bio-based product	Actors	Key markets or applications and value proposition	Cost relative to fossil alternative	GHG saved vs. fossil alternative	European outlook
Isobutene	Production dominated by a small number of players, in the EU by Global Bioenergies and also Lanxess. <i>Outside Europe, Gevo and Butamax are the main developers of isobutanol.</i>	Key applications likely to be for rubber for the automotive industry and also as a precursor for fuel & lubricant additives and biofuels. Could potentially be used as an antioxidant in the food industry.	Could be profitable under current market conditions.	20-80% reduction in emissions depending on feedstock.	In Europe, Global Bioenergies is driving bio-based isobutene research and production and is steadily expanding the market, with additional pilot plants in France and Germany. Lanxess focused on downstream conversion of isobutanol.
Poly-hydroxy-alkanoates (PHAs)	Modest activity in the EU compared with China and the Americas. Biomer and Bio-on are the key EU players. Metabolix is the largest US player.	Fully biodegradable. Potential to be used in most aspects of conventional plastics industry (due to tuneable properties, e.g. similarity to PP and PE). Can be processed in existing petrochemical plastic plants. However, high costs limiting use to niche markets like sutures.	Persistently high costs associated with production. May come down through integration with sugar mills.	Current savings 20% with starch feedstocks, 80% with sugarcane and 90% with lignocellulosic feedstocks.	Some larger plants in the planning stages but due to the higher costs, there is not currently a great deal of momentum behind this material. Large plants have closed. Focus in near term likely to be replacing fossil plastic in niche applications and providing high value with bio-credentials.
Poly-ethylene (PE)	Currently no commercial plants in Europe. Braskem in Brazil is the only commercial scale producer.	Drop-in replacement for fossil PE, the most commonly produced plastic globally – main application in packaging. Not biodegradable but recyclable within current waste separation processes.	Sold at an extra cost of 30-60% compared to fossil PE. Higher production volumes may see price differential decrease.	Current savings of >50% using sugarcane. Higher GHG savings possible with use of LC feedstocks.	EU likely to be a buyer of bio-PE rather than a producer. Brazil likely to continue to be the key producer, due to availability of low cost sugarcane as feedstock. Produced bio-based volumes in the near term are large relative to other biomaterials (with exception of bioPET).
Poly-lactic acid (PLA)	A few large industry participants; NatureWorks (USA) and Corbion Purac (NL) dominate PLA and LA production respectively. There are ~9 other EU producers of PLA and LA.	Bio routes preferred to fossil. PLA suitable for packaging (key market), insulation, automotive part and fibres. Durable, degradable, easily composted and low toxicity. It can be recycled back to lactic acid and can be incorporated into hybrid paper-plastic packing.	Production costs remain unconfirmed, but improved at scale. Has a slightly higher market price than fossil PS, PP and PET.	Currently a 30-70% reduction compared with PP, PS and PET. Could rise to 80% with improved conversion	Given strong drive for bio-based packaging in EU, PLA likely to remain favoured bioplastic in EU to 2020. Share of PLA in Europe's biopolymer production is expected to be ~13% in 2015. Corbion Purac have announced they will become a PLA producer
Succinic acid	2 main actors in Europe (Reverdia, Succinity) and a further 2 globally (BioAmber, Myriant)	Drop-in replacement for fossil succinic acid, and near-drop-in for fossil adipic acid in resins, plasticisers, and polyester polyols, for which it can also provide improved performance.	Equal to fossil alternative since 2013, and was expected to become cheaper. Fossil succinic acid now mainly used in niche applications as a result.	75-100+% savings in GHG emissions. Key factors affecting GHG intensity are feedstock production and grid carbon intensity.	There are significant EU companies but the largest plants and most aggressive growth plans located outside the EU. More than 66% of the succinic acid market should be bio-based by 2015. Production costs expected to fall further.

6. Current European industry competitiveness

This Chapter reviews the competitiveness of developing and producing sugar-based biofuels and biochemicals within the EU, against other leading countries globally; namely the US, Brazil and China. Analysis of the literature has identified the following key criteria as impacting the competitiveness of various regions:

- Policy
- Public perception and consumer demand
- Level of R&D activity
- Level of commercial activity
- Feedstock availability and cost
- Other production costs
- Financing

In this Chapter, these criteria are described and then discussed in relation to the leading countries, followed by an analysis of the current position of the EU vs. the US, Brazil and China.

6.1. Competiveness assessment criteria

Policy

National and regional policy is fundamental in directing research and development, driving industrial growth and creating market demand, for example, national policies and mandates to promote the use of biofuels. Specific policies supporting industrial development and investment in research are key elements for the development of the bio-economy and successfully establishing biofuel and biochemical industries. Policy mechanisms may include the provision of funding for research or capital investment for demonstration or commercial manufacturing plants, market based mechanisms such as mandates or incentives, and public procurement policies.

Public perception and consumer demand

Public perception is linked to regulation and policy, and information campaigns that may be promoted by governments, NGOs, producers and/or brand owners. Negative or positive public perception in specific themes (e.g. environmental protection, abatement of GHG emissions, food vs. fuel debate, NIMBY) can influence technology and market acceptability of new pathways and products such as biochemicals, for example creating and directing market demand. There is limited evidence regarding the public perception of biofuels and biochemicals and how this varies regionally across the globe, therefore this aspect of the assessment criteria is only very briefly considered.

The market for biofuels globally is largely driven by national and regional mandates, whilst markets for biochemicals are currently driven by consumer demands, with products having to offer improved functionalities (including environmental performance) and/or competitive pricing vs. fossil alternatives, as illustrated by the case studies. Biochemicals may be used in a very broad range of chemical and material applications, and the proximity to the downstream user may influence the location selection for manufacturing. However, the chemical industry is a global industry and products are distributed

internationally, at relatively low cost. The influence of downstream demand and its location is expected to vary by product.

Level of R&D activity

Innovation capabilities are an important element for companies to gain and retain competitiveness. The ability to introduce new products and adopt new processes within a shorter lead time is a key competitive advantage³⁷⁰, as is the availability of well-educated and trained personnel to run innovative production processes. Thus the competitiveness of a region can be linked to the strength of research within companies and research institutions that reside in the region.

Level of commercial activity

Technology know-how also influences a company's competitiveness, and in the case of bio-based industries, established supply chains could also provide a competitive advantage for the region. Regions may be characterised based on the companies operating pathways via the sugar platform, by considering how many companies there are, the company sizes, and relevant experience in commercialising and deployment their technologies. Furthermore, the integration of add-on production facilities to already existing industrial infrastructures is an advantage, potentially significantly lowering necessary investments.

Feedstock availability and cost

The quantity, seasonality, quality and price of available suitable feedstocks are of key importance to the deployment location and successful operation of biofuel and biochemical plants. Feedstock costs (i.e. sugar costs) significantly contribute towards production costs of every final product produced via the sugar platform. Typically, due to the low density of biomass feedstocks and low conversion yields, there is a limit the how far feedstocks may be transported for conversion, and therefore regions with a reliable supply of abundant, homogenous, low cost feedstocks have a significant advantage for production of biofuels and biochemicals. Those locations with large harbours and the ability to import significant amounts of raw or pre-treated materials (biobased commodities) will also have an advantage.

Other production costs

In addition to feedstock costs (and process yields), production costs are also strongly influenced by several other factors including capital costs and the cost of finance, operational costs such as wages, employer social contributions, energy costs, and other consumables. Whilst a number of costs should not significantly change across different regions, energy costs and average wages do vary between regions and therefore may be used as an indication of regional competitiveness.

Financing

Accessing project finance for new industries, companies and/or technologies is challenging. The provision of public funding, loans, loan guarantees and/or tax incentives can help mobilise private sector funding. Whilst private sector project finance is not necessarily bound to any specific regions, the availability of support mechanisms to facilitate private sector funding can introduce regional variations in the availability of finance, and the strength of different financial markets and country interest rates can influence the annual cost of the finance raised.

³⁷⁰ Guan, J. C., Yam, R.C.M., Mok C.K., and Ma N. (2006) A study of the relationship between competitiveness and technological innovation capability based on DEA models. *European Journal of Operational Research* 170: 971–986

6.2. Competing regions assessment

6.2.1. Policy and financing

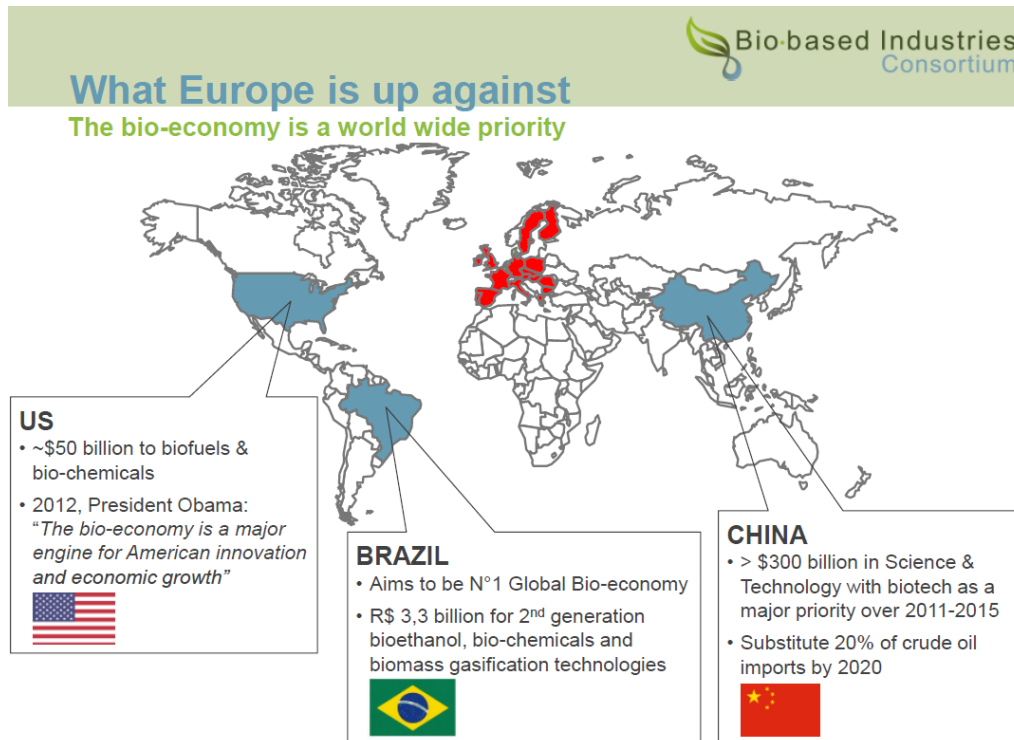

Figure 26: High-level support policy examples from the US, Brazil and China (Source: BIC 2014³⁷¹)

USA

The US has, since 2000, demonstrated an interest in the biochemical sector. The *Biomass Research and Development Act of 2000* showed the US Government's interest in the conversion of biomass into bio-based industrial products as added value products which can also provide environmental benefits, and promote rural economic development. The U.S. Department of Agriculture (USDA) and U.S. Department of Energy (DOE) coordinated allocation of \$500m of funds in 2002 from the Commodity Credit Corporation, and \$14m each year from 2003-2007.

The 2002 *Farm Security and Rural Investment Act* introduced the requirement for each Federal agency to, in procuring items, give preference to those composed of the highest percentage of bio-based products practicable. The subsequent scheme is known as the *BioPreferred Program*, with an expanding list of thousands of bio-based chemicals and materials (e.g. cleaners, carpets, lubricants, paints, bed linen, fertilisers, toner cartridges) with minimum biobased contents, all mandated for federal purchasing³⁷².

³⁷¹ https://www.dsm.com/content/dam/dsm/cworld/en_US/documents/2014-03-04-presentation-significance-of-a-global-bio-based-initiative.pdf

³⁷² <http://www.biopreferred.gov/BioPreferred/faces/Welcome.xhtml>

The *Energy Policy Act of 2005* (Section 943)³⁷³ supported biofuels and biochemicals by offering small businesses marketing and certification grants. It also established the Renewable Fuel Standard (RFS)³⁷⁴. The *Energy Independence and Security Act* (2007) established RFS targets of 36 billion gallons of renewable fuels by 2022, with a cap of 15 billion gallons on corn-biofuels. This policy has been the main driver of the corn ethanol industry in the US, with gasoline vehicles now blending around 10% ethanol in gasoline. The mandated future volumes for cellulosic biofuels are equally significant.

In 2012, the US National Bioeconomy Blueprint was published to reinforce activities around the bioeconomy and bio-based products and defined five strategic objectives for the Bioeconomy. These include supporting R&D investment, facilitating the transition from lab research to market, the development and reformation of regulation to reduce barriers to market entry, updating of training programs, and identification and support of opportunities for the development of public-private partnerships and precompetitive collaborations³⁷⁵.

The US Department of Energy Loan Programs Office has developed a very focused Federal Loan Guarantee programme in support of Renewable Energy and Energy Efficiency. This provided access to Loans to various projects, including advanced biofuel demonstration and first commercial plants. To date, the US DOE have supported approximately **US\$ 1.4 billion** of investment in 29 integrated biorefinery projects, supporting different scale plants with a variety of fuel and chemical outputs (although with a strong focus on LC ethanol and BTL hydrocarbons)³⁷⁶. The DOE are currently undergoing a new Solicitation for another **US \$ 2.5 billion** of loan guarantees, with a dedicated area to Biofuels including drop-in fuels³⁷⁷.

In addition, the US Department for Agriculture supports the development of innovative biorefining projects through a dedicated loan programme³⁷⁸. The Bio-refinery Assistance Program Guaranteed Loans provides guarantees up to \$250m and the Biomass Crop Assistance Program (BCAP)³⁷⁹ provides significant financial assistance to owners and operators of agricultural and non-industrial private forest land who wish to establish, produce, and deliver biomass feedstocks. US financing models therefore cover both the downstream conversion plants and upstream feedstocks.

Brazil

Brazil is a leading country in biofuel production, due to fuel ethanol blending mandates which were first introduced in the 1930s. This has resulted in flexible fuel cars representing almost 90% of the car parc³⁸⁰. The current bioethanol mandate has recently been raised to 27.5%, although has fallen in the past, and fossil gasoline remains subsidised in Brazil³⁸¹.

Biotechnology was identified as a national strategic priority in 2003 culminating in the 2007 decree No. 6,041 (Política de Desenvolvimento da Biotecnologia³⁸²) containing policies regarding R&D support, human

³⁷³ http://energy.gov/sites/prod/files/2013/10/f3/epact_2005.pdf

³⁷⁴ <http://www.epa.gov/oms/fuels/renewablefuels/>

³⁷⁵ http://www.whitehouse.gov/sites/default/files/microsites/ostp/national_bioeconomy_blueprint_april_2012.pdf

³⁷⁶ Chiaramonti (2013) Leaders of Sustainable Biofuels presentation, 8th May, Brussels

³⁷⁷ <http://energy.gov/sites/prod/files/2014/07/f17/Renewable%20Energy%20and%20Efficient%20Energy%20Projects%20Solicitation%20FINAL.pdf>

³⁷⁸ http://www.rurdev.usda.gov/supportdocuments/sc_9003.pdf

³⁷⁹ <https://www.fsa.usda.gov/FSA/webapp?area=home&subject=ener&topic=bcap>

³⁸⁰ <http://www.greenpowerconferences.com/EF/?sSubSystem=Prospectus&sSessionID=5ock61hc8861hb9e006nm1050-12708618&sEventCode=BF1409BR&sDocument=Factsheet>

³⁸¹ <http://www.bloomberg.com/news/2014-09-03/brazilian-senate-approves-higher-ethanol-mandate.html>

³⁸² http://www.mct.gov.br/upd_blob/0016/16386.pdf

capital training and development³⁸³. A Biotechnology Committee was established comprising 23 Federal level agencies and ministries with the aim of developing Brazil's biotech sectors.

The Brazilian Development Bank (BNDES) is the main financing agent for development in Brazil. Since its foundation in 1952, the BNDES has played a fundamental role in stimulating the expansion of industry and infrastructure in the country. In 2011, the Brazilian government released a national development plan called *Plano Brazil Maior 2011 – 2014*³⁸⁴ to stimulate the national economy and industry, specifically to develop new technologies and innovation, and to enable Brazil to compete with other world economies including in the biofuels and biochemical sectors³⁸⁵. The benefits include tax relief (including certain import tax reliefs) and project finance amongst others. During 2011-2014, the BNDES and the state research-financing agency FINEP funded ~**US\$ 450 million** to carry out the Joint Plan for Supporting Industrial Technological Innovation in the Sugar-based Energy and Chemical Sectors (PAISS)^{386,387} focused on second generation bioethanol, new sugarcane products and gasification pathways.

The PAISS was extended in 2014, with an additional ~**US\$ 600 million** of low interest loans (10 years at 4% interest), plus some grant funding, for 2014-2018³⁸⁸. The bank's investment arm, BNDESPar, has also taken equity stakes in the projects. Many companies have benefitted from the PAISS including GranBio, Solazymes, Bunge, CTC and Abengoa Bioenergy.

In 2013, the *Bioeconomy Brazil agenda*³⁸⁹ underlined the need to address the gap between the supply of researchers trained in relevant academic fields and the demand for researchers, and proposed supporting the development of a financial system to assist SMEs in the field of technology by establishing a venture capital industry, integrating and reinforcing the operations of BNDES and FINEP, and providing government guarantees for the financing of technological development projects.

China

China shows a great interest in the “biotechnology sector” as a key element for industrial development. Their 11th Renewable Energy Five Year Plan (2006-2010) reiterated ethanol targets of 3 million tonnes³⁹⁰ for 2010 (with only 1m tonnes allowed from grains), and set guidelines to use marginal land, avoid environmental damage and competition with food and feed – i.e. no increase in grain-based ethanol allowed. As a consequence, only 1.8m tonnes of ethanol production were achieved in 2010. China's 12th Five year Plan (2011-2015) has set a target of 3.5-4m tonnes of ethanol for 2015, with a continued emphasis on marginal lands, non-grain and advanced biofuels. Incentives (funding, tax rebate, investment) are therefore likely to have “non-grain” conditions attached, although these conditions are poorly defined at present³⁹¹.

³⁸³ Building the Bioeconomy Examining National Biotechnology Industry Development Strategies, A Briefing Paper, April 2014

³⁸⁴ <http://www.equilibri.net/nuovo/es/node/2041>

³⁸⁵ Building the Bioeconomy Examining National Biotechnology Industry Development Strategies, A Briefing Paper, April 2014

³⁸⁶ <http://domesticfuel.com/2014/02/17/paiss-program-to-help-brazilian-sugarcane-industry/>

³⁸⁷ <http://www.biofuelstp.eu/spm5/pres/kutas.pdf>

³⁸⁸ <http://www.biofuelsdigest.com/bdigest/2014/02/18/bndes-approves-618-million-in-loans-for-cane-ethanol-innovation/>

³⁸⁹ A Report by Harvard Business Review Analytic Services (2013) BIOECONOMY An Agenda for Brazil

(http://arquivos.portaldaindustria.com.br/app/conteudo_24/2013/10/18/411/20131018135824537392u.pdf)

³⁹⁰ 3.0 million tonnes = 1.0 billion gallons of ethanol

³⁹¹ http://www.energy-trans.de/downloads/Regulatory_Landscape_and_Sustainability_Concerns_for_Biofuels_in_China.pdf

China's Medium- and Long-term Plan for Science and Technology Development 2006-2020³⁹², and the more recent 12th Five-Year Plan³⁹³ 2011-2015, focused on the need to grow its innovation capacity by also increasing R&D and technology diffusion. Spending targets for R&D have been set as a percentage of GDP at 2% by 2010 and at least 2.5% by 2020. The Chinese Government has made additional pledges of close to US\$ 12 billion across the wide biotechnology sector, given the 12th Five-Year Plan 2011-2015 identified biotechnology as a key sector for the development of China's economy. Little data is available regarding Chinese state investment in biofuels or biochemicals.

In terms of regional competition, the Japanese government has set a target that 20% of their plastic production will be from renewable sources by 2020³⁹⁴, and the Thai government has been considering soft loans of US\$ 70 million to promote domestic production of bioplastics³⁹⁵.

Europe

The main policies and funding measures that the EU has put in place to promote innovation, industry investment and drive deployment of biofuels and biochemicals are summarised in Table 7 below³⁹⁶. The scope of each policy/measure is given, along with the main barriers that are addressed by the policy/measure – this links to Section 8.2 on the non-technical barriers facing the industry.

As shown, there have been some significant supported investments and grants for pilot plants and research projects (FP7, EIBI), however, much of the demonstration and flagship (first commercial plant) activity remains in planning. For example, NER300 funds have been awarded, but many advanced biofuels projects have been delayed or put on hold until EU biofuels policy becomes more certain. Similarly, whilst the BBI has €3.7bn (~US\$ 4.3 billion) of funds at its disposal for 2014-2020, it is a new Public-Private Partnership, and stakeholders have indicated that only 1-2% has currently been allocated.

The availability of project finance, which relates to the local policy mechanisms and the availability of grants, loans, loan guarantees, and other incentives including tax exemptions, has to date contributed to the US being a more competitive region for demonstration activities than the EU. However, at this early stage it is not possible to assess how the new BBI mechanism will improve this situation.

³⁹² <http://www.oecd.org/sti/42003188.pdf>

³⁹³ <http://www.kpmg.com/cn/en/issuesandinsights/articlespublications/publicationseries/5-years-plan/pages/default.aspx>

³⁹⁴ http://ijme.us/cd_11/PDF/Paper%2036%20ENT%20202.pdf

³⁹⁵ http://www.sugaronline.com/website_contents/view/1237127

³⁹⁶ <http://www.biofuelstp.eu/funding.html>

Table 7: Summary of existing EU policies and funding measures influencing the sugar platform to biofuels and biochemicals

Policy/measure	What does it do? Scope, organisations impacted, €m available	Which non-technical barriers does it address?
HORIZON 2020 (H2020)	A program coupling research to innovation, providing simplified access to EU funding for all businesses, universities and institutes across Europe and beyond. Total budget of € 87.7 bn ³⁹⁷ (2014-2020). Supersedes the previous FP7 structure, which funded six LC ethanol pilot plants in the EU (~€76m) plus thermo-chemical and algae pilots. Very broad, but Societal Challenges Pillar addresses several bioeconomy aspects ³⁹⁸ , such as biofuels, advanced manufacturing & materials, biotech & nanotech, research infrastructure and training. Focus will be primarily R&D instead of demonstration.	Innovation barriers & financial hurdles: -funds for research and innovation programmes
Public-Private Partnership Bio-Based Industries (PPP BBI)	A new Public-Private Partnership between the EU (€975 m of H2020 funds) and the Bio-based Industries Consortium (€2.7 bn of private investment) ³⁹⁹ . Focus on five value chains, with the aim of: - Demonstrating technologies that enable new chemical building blocks, new materials, and new consumer products from European biomass (residues, wastes and forestry) - Setting-up flagship integrated biorefinery plants, demonstrating cost and performance improvements to levels that are competitive with fossil-based alternatives. - Developing new value chains for bio-based industries, from primary production to consumer markets, creating cross-sector connections and cross-industry clusters.	Investment barriers & financial hurdles: - develop full market-driven value chains - coupling deployment goal to innovation by backward integration - develop markets for bio-based products Feedstock related barriers: - biomass supply, increasing productivity - building new supply chains
European Industrial Bioenergy Initiative (EIBI)	One of the SET Plan industrial initiatives that aim to prioritise and facilitate 'first-of-a-kind' demonstration of innovative bioenergy value chains in Europe, strengthening EU technology leadership and boosting advanced biofuel contribution to 2020 EU targets. 3 selected projects funded >€5.3m (undisclosed) by ERA-NET + BESTF ⁴⁰⁰ Other related calls include ERA-NET 8 th call on integrated biorefineries, and BESTF2. EBTP define the EIBI objectives, framework and the 7 value chains in scope (2 based on sugars) ⁴⁰¹ . New implementation plan covers 2013-2017.	Investment barriers & financial hurdles: - funds for research and innovation programmes - financial support co-financing large demo plants for biofuels
European Biofuels Technology Platform (EBTP)	EBTP brings together advanced biofuels stakeholders across Europe to guide and prioritise RD&D, help meet EU transport targets and to inform the general public with accurate information on various aspects of advanced biofuels. Has a wide range of stakeholders in research, industry, government, NGOs and related professions. EBTP-SABS: Support for Advanced Biofuels Stakeholders (2013-2016) ⁴⁰²	Public perception & communication Collaboration efficiency - provide information about technology, market, policy, finance and deployment activities - connect biofuels community
European Technology Platform for Sustainable Chemistry (SUSCHEM)	An industry-led joint initiative between Cefic, DECHEMA, EuropaBio, GDCh, ESAB and RSC ⁴⁰³ ; part of the external advice of the Horizon 2020 programme, actively engaged in supporting EU-financed projects in research and innovation on sustainable chemistry ⁴⁰⁴ .	Collaboration efficiency - provide information about technology, market, policy, finance and deployment activities -connect biochemicals community

³⁹⁷ European Commission; Brussels, (2012) COMMISSION STAFF WORKING DOCUMENT *Accompanying the document* Communication on Innovating for Sustainable Growth: A Bioeconomy for Europe

³⁹⁸ <http://ec.europa.eu/programmes/horizon2020/en/what-horizon-2020>

³⁹⁹ <http://bbi-europe.eu/about/about-bbi>

⁴⁰⁰ <http://eranetbestf.net/home/>

⁴⁰¹ <http://www.biofuelstp.eu/eibi.html>

⁴⁰² <http://www.biofuelstp.eu/ebtp-sabs.html>

⁴⁰³ <http://www.internationalinnovation.com/suschem-european-technology-platform-for-sustainable-chemistry/>

⁴⁰⁴ <http://www.suschem.org/about-suschem/impact-of-suschem.aspx>

EU emissions trading system (EU ETS)	The EU ETS is an international system for trading CO ₂ allowances which aims to combat climate change by reducing industrial GHG emissions cost-effectively ⁴⁰⁵ . Covers >11,000 power stations and industrial plants in 31 countries, as well as airlines. Over-allocation of allowances and low carbon prices a persistent problem across the various Phases.	Other barriers - encourage the reduction of GHGs emissions Investment barriers & financial hurdles - high carbon price will reduce fossil competitiveness
NER 300	Funds from the sale of 300m EU ETS emission allowances from the New Entrants' Reserve, distributed to innovative CCS and renewable projects, selected through two rounds of calls for proposals, leveraging additional private funding ⁴⁰⁶ . Deadlines for project establishment now extended by 2 years ⁴⁰⁷ . - Phase 1 awarded €1.2bn to 23 projects. 2 were LC ethanol plants (€59m) ⁴⁰⁸ , only Biochemtex built yet - Phase 2 awarded €1bn to 19 projects. 2 were advanced bioethanol plants (€68m) ⁴⁰⁹ , still in planning	Investment barriers & financial hurdles - funds for scale-up activities
European Investment Bank (EIB)	The EU's long term financing institution. Autonomous body set up to finance capital investments furthering European integration by promoting EU policies ⁴¹⁰ . Involved in NER300 due diligence and monetisation of EU ETS allowances. Infrequent investment in biofuels (e.g. €65m for Biochemtex ⁴¹¹).	Investment barriers & financial hurdles - funds for scale-up activities
Renewable Energy Directive (RED)	Mandatory use of 10% renewable energy in the EU transport sector by 2020. Biofuels must have GHG savings of 35% to qualify currently, rising to 50% from 2017 for existing production (60% for new) ⁴¹² . Wastes and residues can be double counted. ILUC has led to years of debate – 1G biofuel cap and advanced sub-target revisions under discussion.	Demand side policy barriers - biofuels mandate Other barriers - biofuels sustainability (reducing GHGs emissions)
Fuel Quality Directive (FQD)	Maximum limit of 10% ethanol by volume in petrol ⁴¹³ . The FQD also has an effect on the permitted level of emissions derived from fossil fuels and includes an obligatory target of 6% of GHG savings in fuels, to be achieved by member states by 2020 ⁴¹⁴ .	Other barriers - biofuels sustainability (reducing GHGs emissions) - biofuel blending
EC sugar market regulation till 2017	Average EU raw sugar prices in June 2013 were more than 50% above world market prices. EU sugar production quotas will be abolished from Oct 2017, which is expected to boost domestic EU production, whilst at the same time lower sugar prices and make the EU market much less attractive to imports ⁴¹⁵ . The sugar quota abolition 'will ensure improved competitiveness for EU producers on the domestic and world market alike', as EU exports are currently limited by WTO rules ⁴¹⁶ .	Market - lower high import prices - improve competitiveness of intermediate and final users of sugars, potentially lowering biofuel and biochemical production costs
Lead Market Initiative (LMI)	Demand-side innovation policy coordination framework for 6 case studies, one of which was bio-based products (main achievement was elaboration of new harmonized European standards, working with industry and CEN working groups) ⁴¹⁷ . Existed 2008-2011, but did not have a dedicated budget ⁴¹⁸ .	Demand side policy barriers - Wide variety of ecolabels and no uniform standard present for sustainable and biobased products

⁴⁰⁵ http://ec.europa.eu/clima/policies/ets/index_en.htm

⁴⁰⁶ http://ec.europa.eu/clima/policies/lowcarbon/ner300/index_en.htm

⁴⁰⁷ <http://www.ner300.com/?p=353>

⁴⁰⁸ http://europa.eu/rapid/press-release_MEMO-12-999_en.htm

⁴⁰⁹ http://europa.eu/rapid/press-release_IP-14-780_en.htm

⁴¹⁰ http://www.eusew.eu/upload/events/508_6547_eib.pdf

⁴¹¹ <http://www.biofuelsdigest.com/bdigest/2013/12/16/european-investment-bank-to-loan-e65m-to-biochemtex/>

⁴¹² <http://www.biofuelstp.eu/sustainability.html>

⁴¹³ <http://www.epure.org/ethanol-for-fuel/eu-regulations>

⁴¹⁴ <http://ec.europa.eu/environment/air/transport/fuel.htm>

⁴¹⁵ http://www.srif.net.fj/web_documents/Par1%20EU%20Sugar%20Sector%20reform.pdf

⁴¹⁶ <http://agritrade.cta.int/en/Agriculture/Commodities/Sugar/Impact-of-CAP-reform-agreement-on-the-sugar-sector>

⁴¹⁷ http://ec.europa.eu/enterprise/policies/innovation/policy/lead-market-initiative/final-eval_en.htm

⁴¹⁸ <http://ec.europa.eu/DocsRoom/documents/5627/attachments/1/translations/en/renditions/native>

6.2.2. Feedstock availability and cost

Carbohydrate crops

Globally, 5.5 bn tonnes of crops are grown each year, containing 2.4 bn tonnes of carbohydrate⁴¹⁹. Figure 27 shows the production volumes of the key carbohydrate-rich commodities (wheat; coarse grains such as corn, barley, oats and sorghum; rice; sugar cane; sugar beet) grown within the EU, US, Brazil and China.

- Brazil is by far the largest sugarcane producer of the countries considered (and globally), although these raw crop tonnages do not reflect the fact that sugarcane is only ~13% sugar by weight. Brazil has comparatively little other production of carbohydrate crops
- The US is a leading region in coarse grains due to its high corn (maize) production. 40% of the US corn harvest already goes to bioethanol production⁴²⁰
- The EU leads on wheat, with modest production of barley and other coarse grains. It is also a global leader on sugarbeet^{421,422} (although sugarbeet is only ~16% sugar by weight). Raw sugarbeet production is expected to rise by up to 30 Million tonnes a year after the end of EU quotas in 2017, leading to cheaper feedstock for establishing sugar platform biorefineries within the EU^{423,424}
- China is the global leader for rice production, along with significant production levels of wheat, coarse grains (corn) and sugarcane

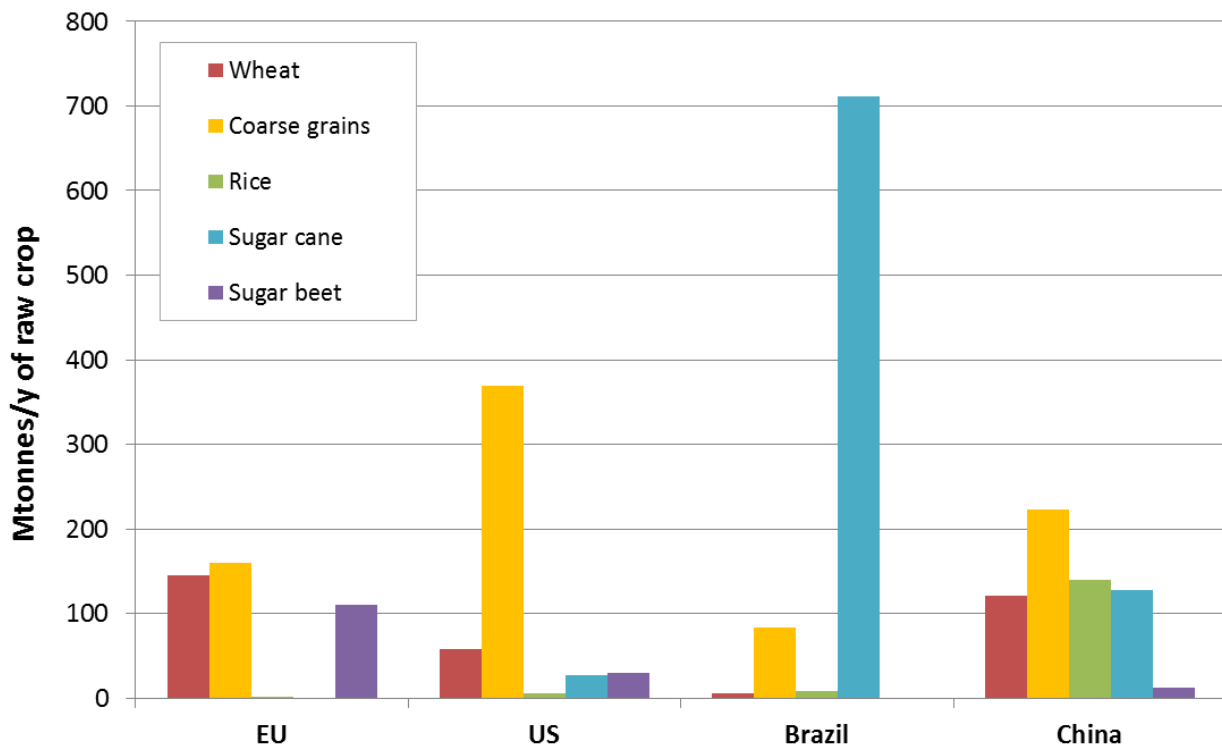

Figure 27: Carbohydrate crop production volumes in 2013, Million tonnes per year of raw crop⁴²⁵

⁴¹⁹ <https://www.rabobank.com/en/images/deloitte-fermentation-study.pdf>

⁴²⁰ <http://www.ictsd.org/bridges-news/bridges/news/european-commission-proposes-duties-on-imports-of-us-biofuels>

⁴²¹ http://ec.europa.eu/agriculture/sugar/index_en.htm

⁴²² <http://www.comitesucre.org/site/wp-content/uploads/2014/04/CEFS-Sugar-Statistics-Inquiry-2013-FINAL-DRAFTv4.pdf>

⁴²³ <http://www2.deloitte.com/content/dam/Deloitte/nl/Documents/manufacturing/deloitte-nl-manufacturing-opportunities-for-the-fermentation-based-chemical-industry-2014.pdf>

⁴²⁴ <http://www.biobasedpress.eu/2015/01/ton-runneboom-major-role-europe-biobased-chemical-industry/>

⁴²⁵ OECD-FAO Agricultural Outlook 2014-2023: <http://www.oecd.org/site/oecd-faoagriculturaloutlook/>

Raw sugar is derived from both sugar cane and sugar beet. Brazil and India are the world’s two largest sugar producers. Together, they have accounted for over half the world’s sugar cane production for the past 40 years⁴²⁶. The price of raw sugar has been around 370 \$/ton in 2014⁴²⁷ and is expected to edge moderately upward on the back of rising costs of production (although likely falling slowly in real terms). Previous years have seen sugar prices falling, in response to consecutive years of a large and growing global sugar surplus and increasing stock replenishment⁴²⁸. Sugar producing regions are therefore likely to continue to be attractive for biofuel and biochemical production.

Prices for carbohydrate crops were volatile between 2008 and 2014 but they have steadied between 300 and 450 \$/tonne carbohydrate equivalents (CHEQ), with the exception of rice which is at around 600 \$/tonne CHEQ⁴²⁹.

Agricultural commodities have global market prices, however local prices differ due to transport costs, regional premiums and semi-finished product discounts. Table 8 illustrates the most suitable first generation fermentative feedstocks in the different world regions based on production volumes and cost, which reflects the current dominant feedstocks for bioethanol production.

Table 8: Most suitable fermentative feedstocks in each world region

REGION	FEEDSTOCK
EU	Wheat and Sugar beet
US	Corn
Brazil	Sugar cane
China	Corn and Wheat

Asia produces a variety of agricultural crops suitable for the sugar platform, in particular sugar cane in India and cassava in Thailand some of the key production centres. China is more focused on production of rice, corn and wheat, which are slightly more expensive carbohydrate sources than Indian sugar cane or Thai cassava⁴³⁰. China also has legislation preventing the new use of food crops in biofuels – however, there are no restrictions on biochemical feedstocks⁴³¹.

Cellulosic sugar and residues

The availability of agricultural residues depends on food crop production volumes, yield factors and the degree of development of regional infrastructure to collect residues. Processing residues are linked to downstream industries, and post-consumer wastes to population centres. The availability of forest residues is linked to the manufacturing of wood based products.

⁴²⁶ http://www.fairtrade.net/fileadmin/user_upload/content/2009/resources/2013_Fairtrade_and_Sugar_Briefing.pdf

⁴²⁷ OECD-FAO Agricultural Outlook 2014-2023: <http://www.oecd.org/site/oecd-faoagriculturaloutlook/>

⁴²⁸ OECD – FAO Agricultural Outlook 2013-2022

⁴²⁹ <https://www.rabobank.com/en/images/deloitte-fermentation-study.pdf>

⁴³⁰ <https://www.rabobank.com/en/images/deloitte-fermentation-study.pdf>

⁴³¹ http://www.energy-trans.de/downloads/Regulatory_Landscape_and_Sustainability_Concerns_for_Biofuels_in_China.pdf

Table 9 illustrates the prices of some of the most common biomass residues in the US⁴³². Wood waste and forestry residues are cheaper than dedicated energy crops. This indicates that regions with high availability of such residues may be more attractive for the production of lignocellulosic biofuels and biochemicals. In addition, in Brazil, large quantities of bagasse are currently produced, the price of which varies significantly between \$ 8-27/tonne, depending on the harvest period and location⁴³³.

Table 9: Cellulosic biomass prices (IRENA, 2012)

Biomass type	\$/tonne
FOREST RESIDUES	15-30
WOOD WASTE from sawmills, pulp and paper mills (bark, chip, sander dust, sawdust)	10-50
AGRICULTURAL RESIDUES (corn stover, straw)	20-50
ENERGY CROPS (poplar, willow, switchgrass)	39-60

China and the rest of Asia have huge potential for producing cellulosic sugars from agricultural residues, but mechanization of agricultural residue collection is still to be implemented at large scale. The US, Brazil and Europe also have significant potentials associated with residues from agriculture and forestry. The US and Brazil have well-integrated and mechanized agricultural sectors that can supply feedstock at competitive costs. Europe generally shows higher lignocellulosic feedstock costs compared to the other regions, due to higher labour and energy costs. The worldwide introduction of dedicated energy crops is only happening slowly at present, due to their lower profitability and longer pay-back times compared to food crops that generally compete for the same land areas.

6.2.3. Level of R&D and commercial activities

The geographical distribution of manufacturing, demonstration and research centres for sugar-based biofuels and biochemicals is illustrated in Figure 28, based on the list of (in scope⁴³⁴) companies gathered in the TRL database, as presented in Section 3.

Of the commercial manufacturing plants, approximately 45% are located in China, 30% in the US, 15% in Europe, and 10% in Brazil. China therefore shows the highest average TRL for its facilities. Lignocellulosic bioethanol production already occurs at commercial scale in all four regions, with the US being the main focus of deployment activities at present. Around 20% of the companies in the TRL database operate facilities in more than one world region – companies are increasingly multi-national, and make investments where it is cheapest to do so (and not only in their home region).

Research centers and demonstration facilities of bio-based companies are instead mostly located in the US and Europe, reflecting the academic and research strengths in these regions, the availability of highly skilled personnel capable of carrying out this work, and hence an attractive environment for research investment.

⁴³² Renewable Energy Technologies: Cost Analysis Series Biomass For Power Generation June 2012 International Renewable Energy Agency

⁴³³ Renewable Energy Technologies: Cost Analysis Series Biomass For Power Generation June 2012 International Renewable Energy Agency

⁴³⁴ Excluding 1G biofuels

Brazil has relatively low levels of activity in R&D, piloting and demonstration, although does have a few early commercial projects.

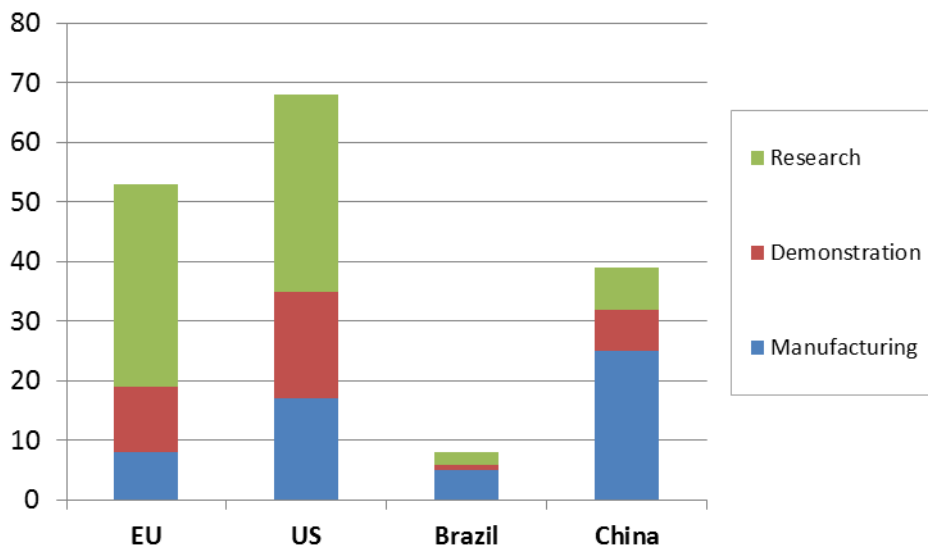

Figure 28: Number of commercial, demonstration and research facilities by region

The EU knowledge base is very well established, but currently mainly being exploited abroad. This is not a recent trend – a historical example quoted in the workshops was that of citric acid, which was established in the EU, but due to production cost competition, all but two plants have moved to China over the decades.

To date, the EU has largely invested in basic and applied research (as shown in Figure 29), more so than in demonstration activities, whilst the US has had a more balanced approach, and China has been more focused on commercial activities. Europe's position with regards to demonstration facilities is however set to improve in the coming years with H2020, NER300 and BBI funded plants (once these are identified and constructed), particularly in the area of advanced biofuels. Figure 29 therefore remains accurate in terms of funds already distributed.

However, other non EU regions have also recently been investing heavily in basic and applied research. Brazil is researching in the field of bio-based products to realize added value from the availability of cheap sugars. Asia is also improving its position in the R&D arena, demonstrated by the increased number of relevant scientific papers published in the last 5 – 10 years.

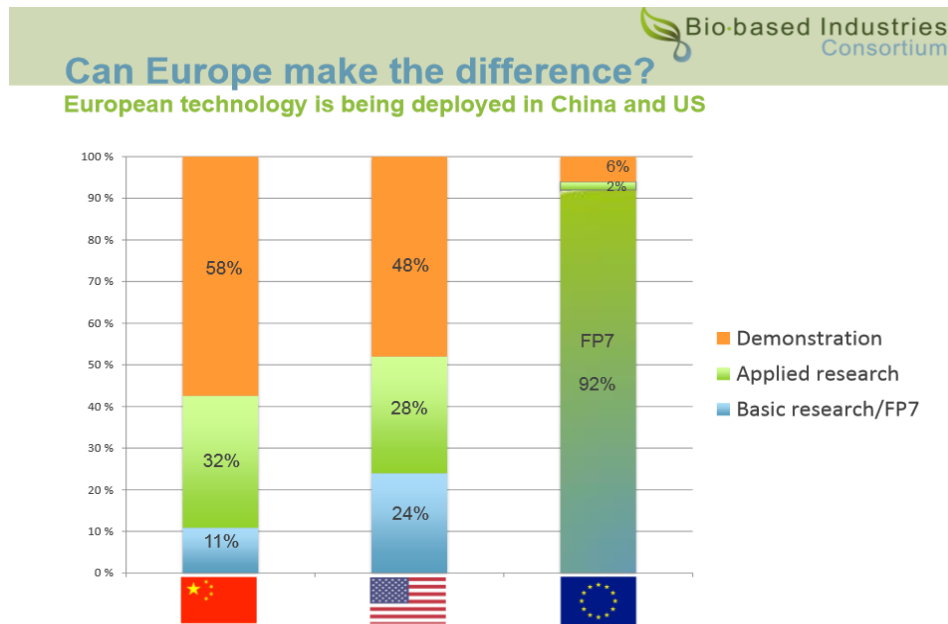

Figure 29: Relative expenditure on demonstration, applied and basic research in China, US and EU ⁴³⁵

6.2.4. Other production costs

Production costs are linked to many factors including feedstock costs and yields, capital costs and the cost of finance, operational costs such as wages, employers social contribution and energy costs. All of these factors are subject to regional variations. In this sub-section, we only examine average wages and energy costs, as finance and feedstocks have already been discussed. Stakeholders have indicated that direct labour costs are usually less important than energy costs to the overall production costs – and that indirect labour costs are mostly wrapped up within the feedstock costs already.

The average wages (\$/month) in the different world regions is shown in Figure 30. This wage survey source ⁴³⁶ highlights a significant difference between the high wages (>2800 \$/month) in Europe and the US, and the low wages (<1000 \$/month) in Brazil and China. Japan and South Korea have similar wages to Europe and the US, but other countries in Asia, e.g. Philippines and India, show very low average wages (~150 \$/month). It should be noted that this national average wage data is being used as a proxy for the wages likely to be experienced by sugar platform pathways within each country – labour force availability and a shortage/surplus of skills required in the sector could mean that the wages relevant to sugar platform pathways are different to the national averages presented. Stakeholders see labour costs and safety requirements continuing to increase rapidly in emerging economies, narrowing the wage cost gap to the more developed EU and US regions.

⁴³⁵ https://www.dsm.com/content/dam/dsm/cworld/en_US/documents/2014-03-04-presentation-significance-of-a-global-bio-based-initiative.pdf

⁴³⁶ <http://www.pwc.co.uk/assets/pdf/global-wage-projections-sept2013.pdf>

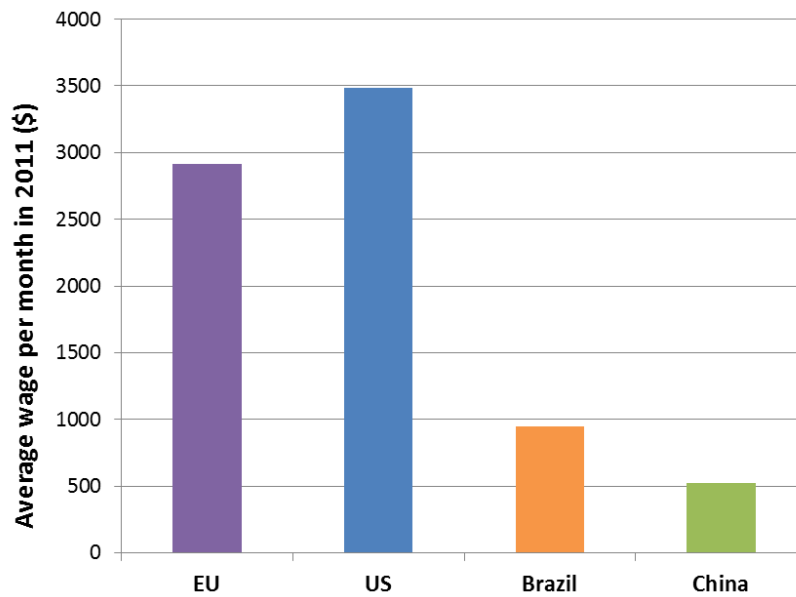

Figure 30: Average monthly wages in 2011⁴³⁷

Electricity costs (in EUR ¢/kWh), shown in Figure 31, illustrate that the US and China generally have low energy costs, whereas Brazil has very high costs. The EU figure of 11.4 ¢/kWh is an average of Member State values ranging between 8 and 21 ¢/kWh.

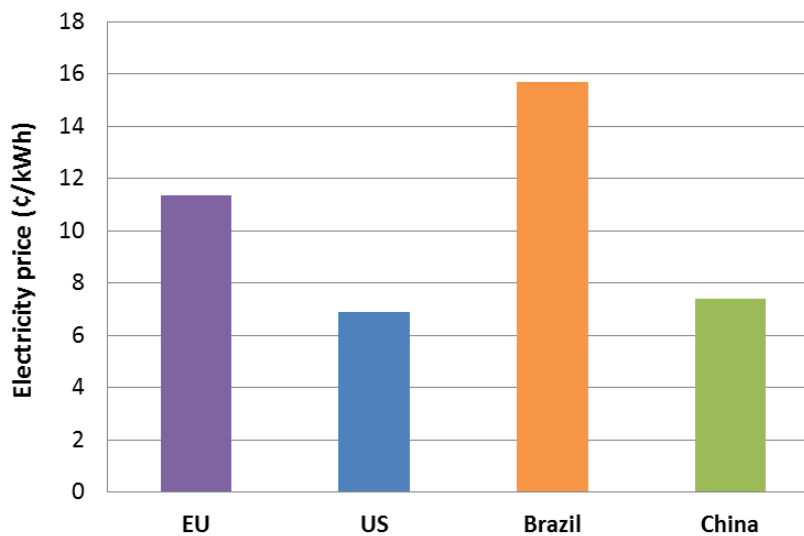

Figure 31: Electricity cost in 2013⁴³⁸

In light of this generic country analysis of average wages and energy costs, China should be the most competitive region, and the EU likely the least competitive. However, true production costs are more complex to evaluate, as they are linked to many other factors such as labour taxation, overheads etc.

⁴³⁷ <http://www.pwc.co.uk/assets/pdf/global-wage-projections-sept2013.pdf>

⁴³⁸ <http://www2.deloitte.com/us/en/pages/manufacturing/articles/2013-global-manufacturing-competitiveness-index.html>

6.2.5. Product markets

The global chemical industry has grown by 7% annually since 1980. Most of this growth has been driven by Asia which now represents almost half of global chemical sales. Increased manufacture in Asia of products within the construction, automotive, electronics, textiles and leather, paper, and personal care and cleaning sectors, has resulted in an increased demand in the region for chemical products and intermediates. In so far as the proximity to downstream users influences the location of chemical manufacturing capacity, locating biochemical manufacturing plants in Asia may therefore be attractive. However, consideration should be given to the regional distribution for specific products.

Figure 32 illustrates the production volumes for a selection of key large volume chemical products: nylon (fiber and resin); acrylonitrile & ABS; PVC, PS, PP & PET; PE (different grades); acrylic, adipic & terephthalic acid; ethylene & propylene oxide; and ethylene, propylene, butadiene, para-xylene, styrene and benzene (Bloomberg, 2014). Data is not available for individual countries, but the chart shows Asia already leading the chemical industry (particularly in alkenes), followed by North America and Europe. South America only has limited chemicals production.

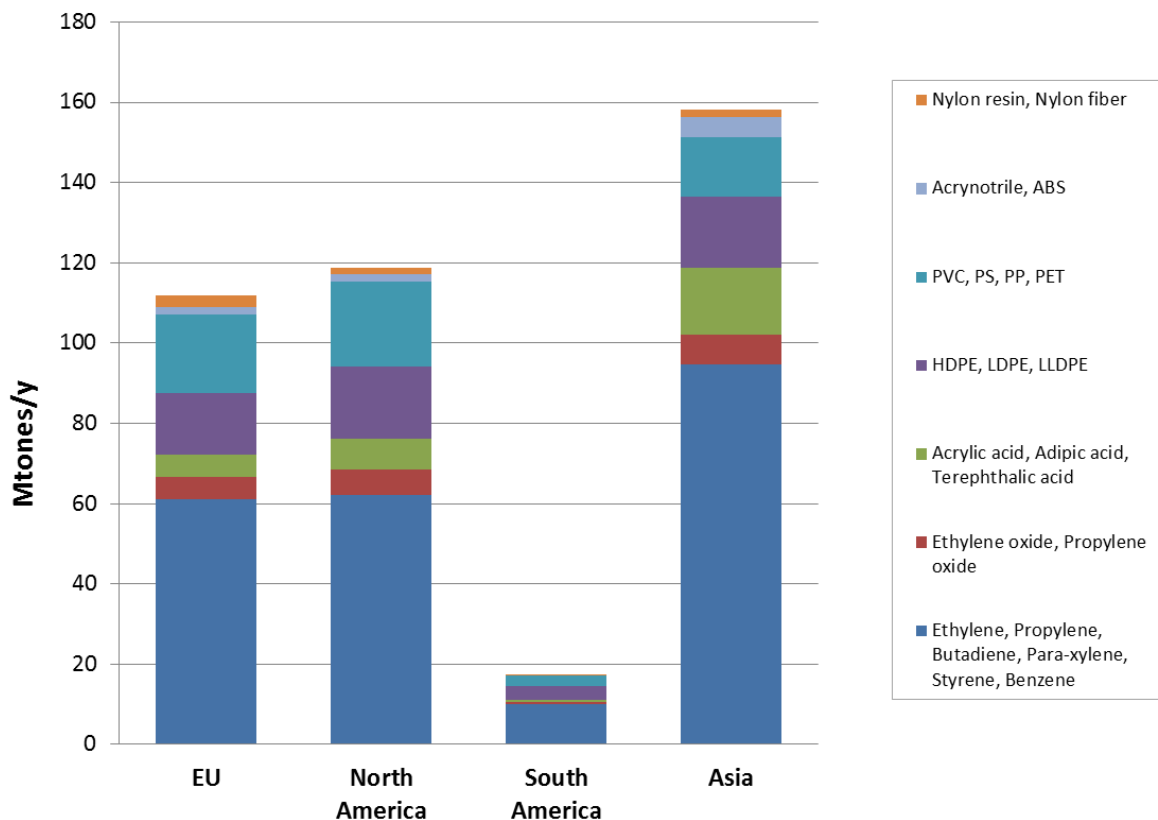

Figure 32: Production volumes in 2013 of the leading chemicals (Data from Bloomberg database)

Figure 33 presents the market value in million USD per year of the chemical products for the selected key chemical products in the different regions. According to this data, the value of the chemicals markets in North America, Asia and Europe are quite similar – i.e. higher production in Asia is offset by lower average product prices.

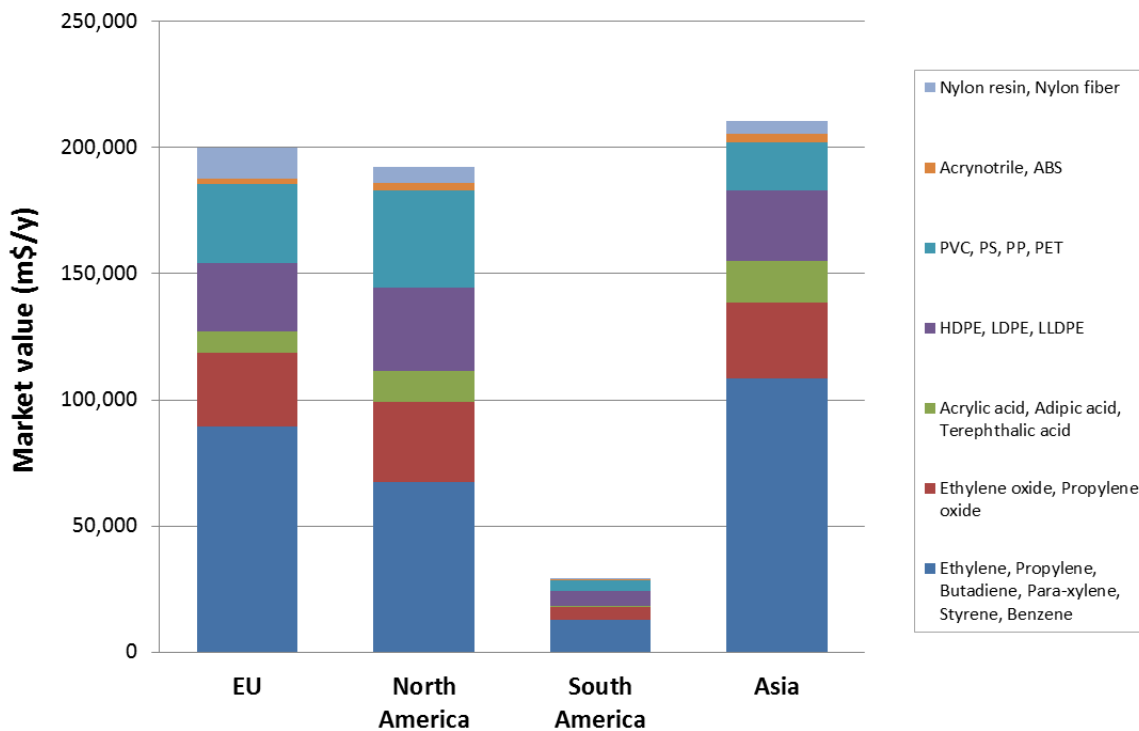

Figure 33: Market value in 2014 of different chemicals (Data from Bloomberg database)

Although price and volume data is available for the majority of fossil-based markets, at various trading hubs, most of the bio-based chemical producers still lack a transparent bio-based commodities market in which to operate, relying instead on bi-lateral agreements. This is in part due to their commercial status, and relative volumes produced vs. fossil counterfactuals.

6.3. European competitiveness

A summary of the status of EU competitiveness versus the USA, Brazil and China is summarised below in Table 10. A rating of “A” denotes a world leading strength that positively impacts the region’s competitiveness, whereas a rating of “C” denotes a competitive weakness, and hence a disadvantage compared to the other regions.

Table 10: EU competitiveness versus the US, Brazil and China (A = strong, B = average, C = weak)

Criteria	EU	US	Brazil	China	Notes
Policy	C	A	B	B	<p>The EU has a high-level bio-economy strategy, recognizing GHG savings and job creation opportunities – but still without resulting actions as to how this transition will be incentivised. The EU lacks long term stable policies in the biofuel sector, with no transport targets set beyond 2020, and those for 2020 still under debate (including caps on 1G biofuels and sub-targets for advanced biofuels).</p> <p>No direct mandates for the use or production of biochemicals exist within the EU. There have been policies such as the Lead Market Initiative to establish appropriate standards, including those on biodegradation and bio-based content. Indirect policies which stimulate the demand for bio-based products include legislation to ban or disincentivise single use plastic bags.</p> <p>In the US, the RFS is seen as one of the most stable and significant mandates for biofuels globally (although was adjusted last year). The RFS lignocellulosic biofuel targets remain high, but very undersupplied at present. The BioPreferred Programme and Biomass Crop Assistance Programme look likely to continue to generate positive impacts for deployment of bioproducts.</p> <p>Brazil and China (plus other Asian nations, notably Thailand, India & Japan) have relatively stable policy environments and some mandates for bioethanol and/or bioproducts in place that have been successful in attracting investment, along with favourite business rates.</p>
Financing	B	A	B	A	<p>Capital is always needed to overcome the technology ‘Valley of Death’, but the availability of large-scale project finance has been restricted and more difficult to obtain since the 2009 financial crisis. The cost of capital is typically lowest in China, due to very high reserves, a controlled currency and artificially low interest rates. Brazil on the other hand has one of the highest costs of capital, due to government deficits. However, BNDES provide low-cost loans and loan guarantees in Brazil, and the US DOE & USDA also provide significant loan guarantees to bio-industrial investments in the US. A lack of similar loan guarantees in the EU is seen as a key financing barrier by developers. Within the EU, high taxation, few incentives, plus a lack of a long term stable framework on biofuels and bioproducts are all seen as limiting the attractiveness of EU for large investors. However, the BBI now has a significant budget to improve the future availability of funds for EU demonstration and flagship integrated biorefineries – to date, there has been insufficient public support for scale-up activities in the EU (above TRL 5), and too much focus on R&D.</p>
Public perception & consumer demand	B	B	B	B	<p>There is little evidence available regarding how the public’s perception or understanding of biobased products varies between regions. However, US and EU customers are typically more concerned with “natural” and “environmentally friendly” products, or locally grown benefits to the rural economy. Some brand owners therefore see value in being able to use bio-based packaging, either for improved properties or for marketing/product differentiation.</p> <p>In general, this perception and demand criterion is strongly dependent on regulatory and supporting policies, combined with information campaigns aimed at improving the sensibility of the general public to these issues. 1G biofuels have come under fire in recent years, over their competition with food and ILUC impacts – the sustainability of mandated biofuels appears to be drawing more NGO and public attention than the sustainability of un-mandated biochemicals at the present time, despite the similar conventional feedstocks being used. However, public perception varies by feedstock, e.g. comparing use of palm oil vs. wastes. Sustainability requirements for biofuels do not currently exist for bio-chemicals (within the EU or elsewhere), with only some bio-product suppliers voluntarily reporting and marketing their sustainability credentials.</p>

Criteria	EU	US	Brazil	China	Notes
Level of R&D activity	A	A	B	B	<p>The EU has largely invested in applied research to date, more than in demonstration, while the US has taken a more balanced approach and China has focused primarily on manufacturing.</p> <p>Asian nations (including China) are rapidly improving their position in the R&D arena, with large increases in scientific paper output seen in the last decade, demonstrating the effort dedicated to R&D.</p> <p>Brazil has understandably focused heavily on sugarcane research, and is starting to move more into 2G ethanol and bioproducts.</p> <p>The EU research base is broad, not just focused on sugar platform pathways, with industry catalyst and material science strengths. The EU knowledge base is well established, with industrial R&D centres and academic strengths in chemical sciences and biotechnology. Biofuels and biochemicals also remain high on EU research agendas for focusing of research funds. The US shares many of these R&D strengths, and both the EU and US have large numbers of highly educated staff able (not necessarily available) to operate novel conversion plants.</p>
Level of commercial activity	C	B	C	A	<p>Existing biochemical manufacturing capacities are strongest in China, typically with the largest and highest number of plants based on conventional feedstocks. Activity in Brazil is limited to a few early commercial plants. EU manufacturing reflects a focus on down-stream value-adding processes, like polymerisation, rather than production of the basic building blocks. As in the US, there is significant existing fossil industrial infrastructure available in the EU that potentially could be used for conversion to biofuel and biochemical production facilities, potentially reducing initial investment costs – particularly for drop-in bio-based products. However, EU unlikely to be world leader if biochemicals industry focuses on retrofitting 1G biofuels facilities.</p> <p>There are first commercial lignocellulosic ethanol plants in all four regions, but with efforts being led by the US. Other lignocellulosic routes to fuels and chemicals are currently very limited.</p>
Feedstock availability & cost	B	A	A	B	<p>For first generation crops, the most important feedstocks are EU wheat, US corn, Brazilian sugarcane and Chinese corn, with significant volumes of each produced each year. China limits 1G crop use in biofuels, the US is already at its RFS mandated level for corn ethanol, and the EU will be tightening its biofuel GHG savings thresholds in 2017, plus is likely to impose a cap on 1G biofuels. However, the end of sugar quotas in 2017 could see more EU sugarbeet feedstock come onto the market</p> <p>For lignocellulosic crops, EU generally shows higher feedstock costs compared to the other regions (due to labour and energy prices), although has the infrastructure for imports. The US also has a well-integrated and mechanized agricultural sector, but is able to supply agricultural and forestry residues at more competitive costs. Brazil has decades of experience in integrating logistics of large agricultural commodities (sugar cane, soy, cereals, etc) to reduce supply cost, with bagasse and trash availability increasing. China and South East Asia have huge potential, but mechanisation of residue collection is still to be implemented at large scale</p>
Other production costs	C	B	B	A	<p>The EU has high energy and labour costs compared to the other regions of the world, which leads to high direct operational costs. Brazil has higher energy costs in general, and the US has higher average wages, but the EU scores second highest on both. The US has lowest energy costs, and China the lowest average wages.</p>

7. Assessment of technology opportunities and barriers

This Chapter discusses the opportunities and barriers faced by the different technologies involved in the initial conversion of biomass to sugars, since this pre-treatment step is common to all value chains. The remainder of the Chapter will discuss the opportunities and barriers faced by the downstream technologies for converting sugars. An overview of the most suitable biomass feedstocks for biorefineries in Europe, including their advantages and disadvantages is given in Appendix B.

7.1. Pre-treatment of lignocellulosic biomass

Both the cellulose and hemicellulose fractions are polymers of sugars, and thereby a potential source of fermentable sugars, or accessible to other processes that convert sugars into products. Hemicellulose can be readily hydrolysed under mild acid or alkaline conditions, or alternatively by appropriate hemicellulase enzymes. In several process set-ups, this hydrolysis already happens in the pre-treatment step. The cellulose fraction is more resistant and therefore requires more rigorous pre-treatment.

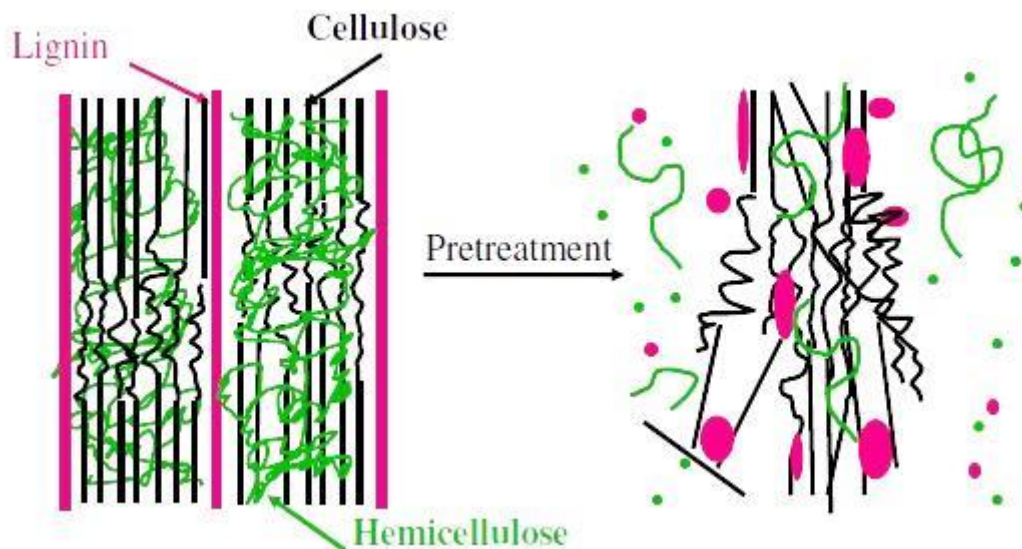

Figure 34: Simplified impact of pre-treatment on biomass (Liu & Fei, 2013)

Pre-treatment is a crucial process step for the biochemical conversion of lignocellulosic biomass. It is required to alter the structure of cellulosic biomass to make cellulose more accessible to the enzymes that convert the carbohydrate polymers into fermentable sugars (Mosier *et al.*, 2005). After initial biomass processing by milling, the production of fermentable sugars is usually approached in two steps (Harmsen *et al.*, 2010; Roderick, 2013):

- 1) **Pre-treatment:** delignification to liberate (or make accessible) cellulose and hemicellulose from their complex with lignin;
- 2) **Hydrolysis:** depolymerisation of the carbohydrate polymers to produce free sugars – for example using acids or enzymes (either produced on location or acquired from enzyme manufacturers).

Pre-treatment has been recognised as one of the most expensive processing steps in cellulosic biomass-to-fermentable sugars conversion and several recent review articles provide a general overview of the field

(Alvira *et al.* 2009; Carneiro *et al.*, 2008; Hendriks and Zeeman, 2008; Taherzadeh and Karimi, 2008; Harmen *et al.*, 2010 & 2013; Chiaramonti *et al.*, 2012). The delignification of raw material is the rate-limiting step in the sequence and the most technically difficult task.

Technical obstacles in the existing pre-treatment processes include insufficient separation of cellulose and lignin (which reduces cellulose accessibility and hence the effectiveness of subsequent hydrolysis), formation of by-products that inhibit downstream fermentation, high use of chemicals and/or energy, high costs for enzymes, and high capital costs for pre-treatment facilities. Other problems in hydrolysis include that aqueous acids often destroy many of the unlocked sugars in the process (Lin & Tanaka, 2006).

Research and demonstration activities are focussed on converting biomass into its constituents in a market competitive and environmentally sustainable way. Table 11 reviews some features of major pre-treatment pathways for lignocellulosic biomass, including their Technology Readiness Level (TRL). Generally speaking, pre-treatments can have different effects on lignocellulose biomass such as the increase of surface porosity, separation of hemicellulose, alteration and/or removal of lignin, hydrolysis of cellulose and hemicellulose, and decrystallization of cellulose. All these effects are thought to have a beneficial effect on the enzymatic degradability of cellulose and hemicellulose in lignocellulosic biomass (Kumar *et al.* 2009).

Table 11: Lignocellulosic biomass pre-treatment technologies (Harmsen et al., 2010; Garcia et al., 2014)

Technology	TRL	Opportunities	Barriers	Mitigations	Notes
Steam explosion	6 - 8	Cost-effective High glucose yields Lignin and hemicelluloses removal Low environmental impact	Often catalyst needed to optimise pre-treatment Formation of inhibitors and toxic compounds	Development of new catalysts Developing Microorganisms more tolerant to inhibitors	Suitable for variety of herbaceous and woody feedstocks At 1 st commercial plant scale
Dilute acid pre-treatment	5 - 7	Good removal of hemicelluloses	Degradation by-products (salts) and inhibitors Corrosion	Developing Microorganisms more tolerant to inhibitors Reducing intensity of pretreatment New enzyme developments	Particularly suited for low lignin feedstocks
Concentrated acid hydrolysis	4 - 5	No enzymes needed Good removal of hemicelluloses	High chemical use and capex Corrosion and toxic hazard Degradation by-products (salts) and inhibitors	Recovery and reuse of chemicals Developing new catalysts More tolerant microorganisms	Suitable for variety of feedstocks including MSW
Auto-catalysis/hydrothermal	4 - 6	No chemical use or residues High glucose yields	Higher operating temperature Inhibitor formation	Develop methods to add value to lignin	Scale up to pilot scale realised Suitable only for low % lignin
Organosolv treatment	4 - 6	Causes lignin and hemicellulose hydrolysis	High capital and operating costs Solvent may inhibit cell growth	Develop methods to add value to lignin Recovery and reuse of chemicals	High quality lignin co-product
Alkaline pre-treatment (e.g. dilute ammonia, NaOH, lime)	5 - 7	Low capital costs Low inhibitor formation High glucose yields	Residue formation Need to recycle chemicals Enzyme adjustment needed	New enzyme development Recovery and reuse of chemicals	Suitable for smaller scale plants
Ammonia Fibre Explosion (AFEX)	3 - 5	No need for small particles Low inhibitor formation High accessible surface area	High cost due to solvent	Recovery and reuse of chemicals	Suitable for smaller decentralised plants Not effective for high % lignin
Supercritical (CO₂) pre-treatment	2 - 4	Increases accessible surface area Low inhibitors or residues	Does not affect lignin and hemicelluloses V. high pressure, high capex	Develop methods to add value to lignin Improve process technology	Continuous technology Suitable for smaller scale plants
Ionic liquids	2 - 3	Effective dissolution of all lignocellulose components Low degradation products	Expensive technology and recovery required	Develop methods to add value to lignin Recovery and reuse of chemicals Develop process technology	
Microbial/fungi	3 - 4	Low energy requirement No corrosion Suitable for lignin and hemicelluloses removal	Time consuming Some saccharide losses	Development of robust microorganisms	
Mechanical milling	5 - 6	Reduces cellulose crystallinity No inhibitors or residues	High energy consumption Poor sugar yields	Process integration, combine with mild chemical treatments	

7.1.1. Feedstock constraints

Some of the pre-treatment technologies are flexible to a variety of biomass feedstocks, with many designed to operate on woody biomass feedstocks. However, there are some notable exceptions:

- Dilute acid pre-treatment requires low lignin feedstocks to be cost effective and unlock sufficient cellulose, hence is particularly suited to agricultural residues and grassy energy crops
- Hydro-thermal conversion (auto-catalysis) requires similarly low lignin feedstocks to avoid detrimental inhibitor formation
- Ammonia Fibre Explosion (AFEX) does not need small particles as input (unlike many of the other routes), however, is not effective at unlocking sufficient cellulose when using high lignin feedstocks
- Supercritical CO₂ does not impact lignin and hemicellulose fractions, so ideally levels of these should be low in the starting feedstock

The cost-effectiveness of the pre-treatment technology depends on the overall system configuration. The more mature pre-treatment technologies include steam explosion, hydrothermal pre-treatment, concentrated acid hydrolysis (van Groenestijn et al., 2006), and dilute acid pre-treatments (Mosier *et al.*, 2005).

7.1.2. Commercial activity

At the moment, the production of ethanol from lignocellulose is growing rapidly, and by looking at the industrial activities in this field more knowledge can be gained on the applied pre-treatment methods. The International Energy Agency (IEA) employs a Bioenergy Task 39 entitled 'Commercializing Conventional and Advanced Liquid Biofuels from Biomass'. From these and other more recent reviews such as Harmsen et al (2013), we present an overview of current industrial scale up activities.

- **Steam explosion** is by far the most applied pre-treatment technology by industrial companies. Abengoa (a large ethanol producer from cereals) produces ethanol from wheat straw or corn stover in demonstration plants in Spain and the US by sulphuric acid-catalysed steam explosion, and is completing construction of its first commercial plant in Hugoton, Kansas. All by-products, including lignin residues, are used for energy applications. Iogen have been operating their Canadian demonstration plant since 2011. BetaRenewables has been operating a first commercial plant in Crescentino, Italy since 2013 for the production of ethanol from Arundo Donax (giant cane) plus wheat and rice straws. The pre-treatment applied reportedly is uncatalysed steam explosion, and is licensed by Biochemtex to other companies under the name PROESA. Sugars are further converted by simultaneous saccharification and fermentation to ethanol, and residual lignin is used as energy source.
- Several companies use **dilute acid** as pre-treatment method for fractionation of lignocellulosic biomass. Blue Sugars in the US has a demonstration plant for the production of ethanol from sugarcane bagasse. They combine dilute acid with mechanical action and co-ferment the C5 and C6-sugars. Cobalt Technologies, in cooperation with Rhodia and Andritz, are building a demonstration plant in Brazil for the production of butanol from sugarcane bagasse. They combine dilute acid hydrolysis with ABE-fermentation and claim that enzymatic hydrolysis is not necessary in their process. Quad County Corn Processors have just commissioned (in July 2014) their bolt-on Adding Cellulosic Ethanol ("ACE") technology, to convert residual corn stillage into ethanol at their much larger corn grain to ethanol plant. POET-DSM is currently finishing the building of its first

commercial cellulosic ethanol plant in the US, with an expected start-up in 2014. POET is the largest ethanol producer from corn in the US and the new plant will use corn cobs and/or corn stover as biomass for their process. The pre-treatment technology is dilute acid or acid catalysed **steam explosion** followed by enzymatic hydrolysis with enzymes provided by DSM. In Europe the Swedish company Sekab is producing ethanol on demonstration scale from softwood, straw and sugarcane bagasse. The lignin fraction is dewatered to 50% dry matter and is used as solid biofuel.

- Inbicon in Denmark produces ethanol from straw by **autohydrolysis** at demonstration scale. Advantages of this process include the absence of chemicals and the low water use as they operate at high dry matter content (>30 wt%).
- On industrial scale only DuPont (Danisco) applies **alkaline** pre-treatment for their biomass pre-treatment. The pilot plant in the US produces ethanol from lignocellulosic biomass (switchgrass, corn cobs, corn stover) by dilute ammonia hydrolysis followed by enzymatic hydrolysis to produce the fermentable sugars. Their first commercial plant in Nevada, Iowa is nearing completion of construction, and is due to commission in 2014.
- To date, several companies are in the process of commercialising **concentrated acid hydrolysis** of lignocellulosic biomass. Virdia (formerly known as HCL Cleantech) produces sugars from lignocellulosic biomass by using concentrated HCl. Their CASE™ process is demonstrated at pilot scale at the moment and samples of cellulosic sugars and lignin are being produced for commercial application testing. In Europe the Norwegian company Weyland is producing sugars and lignin on pilot scale since 2010. They mainly use wood and agricultural residues as biomass source.
- **Organosolv** originates from the pulp and paper industry where it was developed as an alternative for kraft pulping. To date several companies use the organosolv technology for the fractionation of biomass. Chempolis in Finland uses a mixture of formic acid and acetic acid in water as pulping liquid. The Formico Biorefinery Technology processes non-wood biomass on demonstration scale. From the cellulose fraction ethanol and paper pulp is obtained, from the hemicellulose fraction ethanol, furfural, acetic acid and formic acid, and the lignin is used to generate power and steam. Also, CIMV in France uses formic acid and acetic acid for their organosolv process. The pilot plant is running since 2006 and processes wheat straw into a variety of intermediate products: paper pulp and glucose from cellulose, C5-sugars from hemicellulose, and lignin for the chemical industry (not as fuel). Lignol in Canada uses ethanol as solvent in their Alcell process.
- BioGasol in Denmark combines **wet oxidation** with **steam explosion** for the production of ethanol from agricultural residues. The process is called 'wet explosion' and the use of oxygen and pressure release at high temperature (170-200 °C) are combined. All by-products are further converted to energy carriers (e.g. ethanol, hydrogen, methane and solid biofuel). A demonstration plant is running in Denmark since 2011.

Overall, the main obstacles for further scale up of pre-treatment techniques are high capital costs, and high costs for enzymes. In addition, many pre-treatment pathways are developed for one feedstock, and pre-treatment conditions (as well as enzymes) need to be modified when other lignocellulosic feedstocks are used.

7.1.3. Enzymes for lignocellulosic biomass pre-treatment

As noted above, one of the major cost components in production of fermentable sugars from lignocellulose are costs for the cellulase enzymes required in enzymatic hydrolysis. The costs are high due to high enzyme dosage requirements used (in comparison with enzyme use for starch hydrolysis), as well as high costs of the enzyme cocktail obtained from a commercial suppliers.

A recently published study presented cost estimates for enzymes that would be representative of what would be used in a commercial setting (Hong et al; 2013). This estimated the cost of enzymes at \$3.80 to \$6.75 per kg of enzyme protein for on-site production, and a cost of \$4.00 to \$8.80 kg per kg of enzyme protein for off-site production. Taking into account enzyme dosages that are commonly reported for hydrolysis of pre-treated lignocellulose, enzyme costs are estimated to be in the range of \$ 0.46/gal, or \$0.12/litre – although this dosage of 11.5mg enzyme/g substrate is dependent on feedstock and enzymatic hydrolysis conditions. This agrees well with the latest survey findings from Bloomberg (2013), as shown below in Figure 35.

Therefore, enzyme costs are still a considerable cost in conversion of lignocellulose to fermentable sugars. Efforts by industry are under way to reduce costs of enzymes for lignocellulose conversion (Novozymes, 2014; DuPont, 2014), and enzyme costs have fallen rapidly in recent years as dosage requirements and pre-treatment techniques have been optimised, and lignocellulose enzyme production ramps up to mass commercial-scale.

ENZYME COST CONTRIBUTION PER LITRE OF ETHANOL PRODUCED, 2008-16 (\$ PER LITRE)

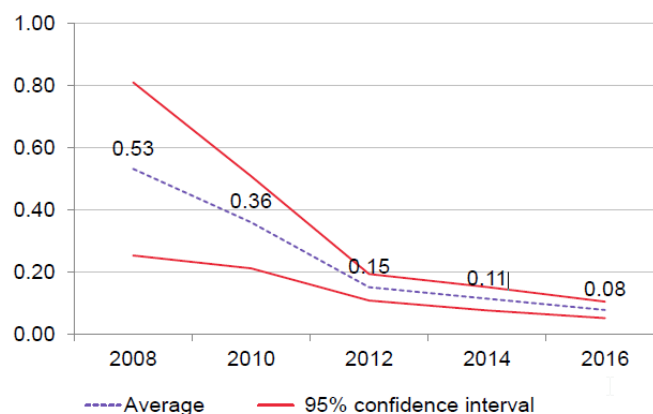

Notes: the 95% confidence interval represents the area within which 95% of the participant MESPs fall – or two standard deviations from the mean, where enzyme manufacturers have contributed survey data, it is important to note they have included a profit margin.

Source: Bloomberg New Energy Finance

Figure 35: Enzyme cost contribution per litre of LC ethanol (Bloomberg, 2013)

7.2. Downstream conversion of sugars

A large number of value chains have been selected from the mapping exercise and the literature survey, each having a fuel, chemical or polymer as an end product. Table 12 below gives the list of products selected for analysis – this contains the list of 25 primary products discussed previously, plus an additional 8 downstream bio-based polymers (with isoprene, ethylene and MEG considered within these polymers). In these pathways, the different technologies involved in converting sugars into the end products will be evaluated in terms of opportunities and barriers, along with a discussion of potential mitigation activities.

Table 12: Products selected for opportunities and barriers analysis

Alcohols	Organic acids & other	Polymers
Ethanol	Acetic acid	PLA (via lactic acid)
n-butanol	Lactic acid	PET (via p-xylene and ethylene glycol)
ABE/IBE	Itaconic acid	PBS (via succinic acid and BDO)
Isobutanol	Succinic acid	PEF (via FDCA)
1,3-propanediol (PDO)	Levulinic acid	PE (via ethylene)
1,4-butanediol (BDO)	para-xylene	PMMA (via itaconic acid)
Xylitol	3-HPA	PHAs (direct), including PHB/PHBV
Sorbitol	Acrylic acid	Polyisoprene (via isoprene)
	Adipic acid	
	Furfural	
	5-HMF	
	FDCA	
	Iso-butene	
	Farnesene	
	Algal lipids	

Given the similarities between the routes to produce each of the products within a grouping, the following sections are therefore ordered by grouping in order to better highlight the similar opportunities and barriers for each product within that grouping.

In terms of which countries and companies are responsible for the most significant advances currently happening in each product, this topic has been comprehensively covered (at some length) by a range of sources. The most useful sources include de Jong et al. (2012 & 2014), BioREF-INTEG (2010), Weastra (2013), Star-COLIBRI (2010), Balan et al. (2013), Straathof (2014), Harmsen & Hackmann (2013), and Babu et al. (2013). We also note that Table 4 shows those companies at the forefront of development and commercialisation of each product, which is a good summary of the main developers of each product.

The majority of the barriers faced by alcohol production processes in Table 13 either relate to the energy and economic cost of product separation (given the miscibility of alcohols and water), and the low concentrations of end-products in the fermentation broth due to toxicity effects of the end products on the micro-organisms.. The organic acids barriers in Table 14 are more heavily focused on purities, reducing unwanted by-products and the need to improve selectivity of the processes (particularly the chemical catalytic routes). Table 15 shows that biopolymers are particularly focused on monomer purity, production cost vs. the fossil counterfactual, as well as the ability to use drop-in molecules and/or improve properties.

Table 13: Opportunities and barriers facing alcohols production

Product	Feedstock	Process	Opportunities	Barriers	Mitigations
Ethanol	LC sugars, C6-rich fraction	Fermentation using non-GM microorganisms	High yields Process at scale	High cost and energy use in product separation	More efficient downstream processing techniques
Ethanol	C6, C5 sugars	Fermentation using GM yeasts	Efficient utilisation of sugars High yields	Strains developed so far are not stable enough High cost and energy use in product separation	New strains with improved stability More efficient downstream processing techniques
Ethanol	C6, C5 sugars	Fermentation by GM yeasts or bacteria, via consolidated bioprocessing	No or low use of external enzymes Better economic and environmental results, with lower capex	High energy use in product separation Low productivity due to substrate/product inhibition and slow degradation of substrates	Improved strains with higher productivities Efficient integration of pre-treatment with fermentation steps
n-butanol	C6, C5 sugars	Fermentation by anaerobic bacteria	n-butanol has good properties uses as fuel (jet, diesel additive) Process at scale	Low yields of product Low productivity High energy use in separation	More efficient downstream processing techniques Continuous cultivation techniques
ABE/IBE	C6, C5 sugars	Fermentation by anaerobic bacteria	ABE/IBE mix has good properties uses as precursor of fuel (jet, diesel) or lubricant	Low product yields C5 conversion technology still under development	More efficient downstream processing techniques Continuous cultivation techniques
Iso-butanol	Sugars	Fermentation by (GM) microorganisms	Retrofitting to existing 1G ethanol plants, hence potential for low capex	Low productivity Toxicity of isobutanol to microorganisms High product separation costs	More robust and tolerant strains
PDO	Sugars or glycerol	Fermentation by (GM) microorganisms	High yields Flexibility in substrates: sugars and glycerol can be used	Product separation costs are high	More efficient downstream processing techniques
BDO	C6, C5 Sugars	Fermentation by (GM) microorganisms	Drop-in for fossil BDO LC sugar routes being developed	Low productivities Product tolerance needs improving	Higher yielding and more tolerant strains
Xylitol	C5 sugars	Hydrogenation of xylose	High end concentrations High yields Utilisation of C5 sugars	Downstream processing needs further development	Efficient and selective purification methods
Sorbitol	C6 sugars	Hydrogenation of glucose	High end concentrations High yields	Costly separation Downstream processing needs further development Batch process, could be continuous	Efficient and selective purification methods

Table 14: Opportunities and barriers facing the production of organic acids and other chemicals

Product	Feedstock	Process	Opportunities	Barriers	Mitigations
Acetic acid	C6, C5 sugars	Anaerobic fermentation by bacterial strains	Use of C5, C6 sugars Both thermophilic and mesophilic microorganisms available	Low end concentration of product	Develop strains more tolerant to acetic acid Improve the separation and purification methods
Lactic acid	C6, C5 sugars	Fermentation by bacterial strains	High yields of product Lactic acid has multiple applications Process at scale	Fermentation of lignocellulosic streams under development Broth separation needs improving	Integrate biomass pretreatment and fermentation steps
Itaconic acid	C6, C5 sugars	Fermentation (fungi or bacteria)	High yields Use of C5, C6 sugars Ability to switch citric acid capacity over	Not a drop-in for maleic anhydride polyester resins - downstream conversion to MMA not yet commercial Lower production costs needed to compete	Develop applications for Itaconic acid and its products
Succinic acid	C6, C5 sugars	Fermentation by GM microorganisms	Multiple applications via BDO and PBS Process at scale. May be lower cost than fossil	Lower production costs needed to compete	Improve strains for yields and productivity
Levulinic acid	C6 sugars	Fructose dehydration to 5-HMF, hydrolysis to LA	Formic acid co-product	Unwanted salts, humins deposition Equipment acid corrosion Difficult to recycle catalysts 5-HMF instable intermediate	Improve or develop new separation and purification techniques
para-xylene	Isobutanol	Dehydrogenate to isobutene, dimerise to para-xylene	High process yields & selectivity Drop-in already used by fossil industry at scale, oxidation route to Terephthalic Acid well established	Very high purity needed, due to pure TPA requirements in PET production Equipment corrosion	Improve or develop new separation and purification techniques
3-HPA	Sugars or glycerol	Fermentation by GM microbes	Feedstock flexible	Yields need significant improvement	Develop strains with higher yields
Acrylic acid	3-HPA	Oxidation and dehydration of 3-HPA	Relatively simple chemical process	High capital costs	Improve or develop new separation and purification techniques
Adipic acid	Sugars	Fermentation by GM microorganisms	Drop-in Potential for lower cost than fossil benzene route	Extraction at purity levels needed for polyamide production needs work	Development of extraction methods from fermentation broth

Furfural	C5 sugars	Dehydration of xylose	Common degradation product from acid hydrolysis of sugars Downstream derivatives well developed	Expensive to remove impurities (in particular humins), other alcohols and organic acids Further process optimisation needed	Improve or develop new separation and purification techniques
5-HMF	C6 sugars	Dehydration of glucose or fructose	Currently extremely high production costs, but potential to drop dramatically	Expensive catalysts, toxic solvents, high pressure, costly extraction Low yields, decomposes to levulinic & formic acid	Develop ways of stabilise the product Improve or develop new separation and purification techniques
FDCA	5-HMF	Oxidation of 5-HMF	Non drop-in replacement for TPA in PET (making PEF)	Intermediate 5-HMF highly unstable	Develop ways to stabilise the product New routes avoid 5-HMF
Iso-butene	C6 sugars	Fermentation by GM bacteria	Gaseous product easy to separate Minimal toxicity to microbes Multiple applications, downstream well developed	Currently low yields, hence highly dependent on feedstock sugar costs	Develop strains with higher yields Adapt microbes to use cheaper feedstocks
Iso-butene	Isobutanol	Catalytic dehydration	Relatively simple chemical process	Availability of bio-based isobutanol feedstock	Gevo and Butamax to commercialise isobutanol plants
Farnesene	C6 sugars	Aerobic fermentation by yeast or algae	Isoprenoid properties can be tuned by GMO Product does not contain oxygen atoms	Higher yields, productivity and concentrations needed Expensive extraction	Develop strains with better performance Improve or develop new efficient extraction techniques
Algal lipids	Sugars	Fermentation by heterotrophic algae	High cell density cultivation Wide range of application of products	Low yields Extraction of lipids from wet biomass needs to be improved Purification of products needs optimisation	Develop improved strains with higher yields and selectivity of products Improve separation

Table 15: Opportunities and barriers facing polymer production

Product	Feedstock	Process	Opportunities	Barriers	Mitigations
PLA	Lactic acid	Ring opening polymerisation of the lactide (dimer)	Properties can be tuned by changing the d-l ratio Can be compostable High temperature resistant PLA is in development	Not drop-in Relatively poor mechanical properties (impact/tear strength) Poor high temperature properties limit use in coffee cups & bottles	Investing in materials development will improve mechanical and high temperature properties and extend application area
PET	Ethanol and iso-butanol	Polycondensation of ethylene glycol and terephthalic acid	Drop in, thus the same as the fossil alternative. Can also be recycled with the fossil alternative	Production of biobased terephthalic acid is not yet in place. Price is not yet fully competitive with fossil PET	Process development for production of biobased terephthalic acid is necessary
PBS	Succinic acid and BDO	Polycondensation of succinic acid and BDO	Fossil variety exists (drop in) Properties similar to PP, the second largest polymer, thus potential application area is enormous	Price, if PP market is the target.	Further optimisation of the process is likely to reduce price
PEF	Ethanol and FDCA	Polycondensation of ethylene glycol and FDCA acid	Similar to PET but with superior barrier, high temp. and tensile strength properties	Not drop in, so product development needs to be taken up	Investment in product and market development necessary
PE	Ethanol	Polyaddition of ethylene	Commercial Drop-in, the same properties as fossil PE, including recycling options	Price, PE can be made relatively simply from fossil feedstock Feedstock efficiency: >3.5 kg of sugar/kg PE	Feedstock inefficiency cannot be solved. Develop other materials (if polyesters) with same properties profile
PMMA	Itaconic acid	Polyaddition of methyl methacrylate	Drop in, same properties as fossil PMMA	Early status of the technology Several steps: decarboxylation of IA to methacrylic acid, then esterification to MMA	Further R&D required
PHAs	Sugars	Bacterial fermentation in micro-organisms	Biodegradability is an important asset Properties can be tuned by changing the chemical composition. PHB properties similar to PP	Price Down-stream processing Market applications not yet well developed. Not drop-in	Investing in better DSP will lower price. Investment in product and market development necessary
Poly-isoprene	Isoprene	Addition polymerisation	Drop in, same properties as fossil poly-isoprene	Properties of natural rubber are superior (higher purity and molecular weight)	Market development for other markets than natural rubber market necessary

8. R&D gaps and industry needs

8.1. Technical gaps in research

The previous section of this study described the technical barriers and mitigations facing each conversion processes for the production of a number of selected biofuels and biochemicals via sugars. These technical barriers refer to techniques or processes that are suboptimal and need improvement. This section discusses the R&D gaps within sugar platform pathways, i.e. those research fields where it is known that more attention/effort needs to be focused to overcoming barriers that impact multiple chains – as well as discussing those barriers which already have sufficient current efforts underway.

In terms of the number of years required to overcome a particular barrier, we have consulted literature, asked experts and consulted stakeholders via the project workshops, but none of these avenues have given numerical results – stakeholders have suggested it is too difficult to get an answer, with too many uncertain variables (not least how to accurately define when a barrier is overcome). We note that the Bio-TIC project is an order of magnitude larger exercise than this current study, focusing specifically on barriers and mitigation efforts, but they have not produced indicative timeframes for mitigating actions yet. We therefore discuss the barriers and possible mitigations below, without indicating likely timeframes.

8.1.1. Lignocellulosic biomass fractionation and pre-treatment

There are many technologies developed for the fractionation of lignocellulosic biomass: some of these have already achieved high TRL levels (>6). However, there are still a number of technical issues, resulting in R&D needs that require further attention:

Substitution of corrosive chemicals

Current processes for the pre-treatment of lignocellulosic biomass that use corrosive chemicals include steam explosion, since the biomass is usually impregnated in acid, (dilute) acid hydrolysis and alkaline hydrolysis with concentrated alkali solutions. The use of corrosive chemicals has an important impact on process economics and production costs. In particular, the need to use expensive corrosion-resistant materials in the construction of industrial plants leads to high capital costs. Further development of processes that utilise less corrosive chemicals while maintaining high yields of solubilisation of sugars, will mitigate this barrier. Some EU companies are already adopting no-chemical pre-treatment processes in their demonstration plants, so to reduce the overall investment costs.

Reduce the inhibition of downstream fermentation

Many pre-treatment processes result in the formation of compounds that have a negative effect on the downstream fermentation. For example, in pre-treatments using high temperature and low pH (steam explosion, acid hydrolysis) inhibitors are formed due to the degradation of sugars into furfurals; in alkaline pre-treatments the solubilisation of lignin monomers or organic acids forms inhibitors; and the presence of organic and inorganic acids (acid hydrolysis, organosolve) inhibits microbial growth. The presence of inhibitors results in the need for expensive purification steps, which often need to be adjusted to the specific conditions of the fermentation process. The impact may be reduced by either developing new pre-treatment processes with reduced inhibitor formation, or by new downstream fermentation strains with

greater tolerance to inhibitors. This second approach has been successfully tested in the case of fermentation of organosolve hydrolysates from wheat straw with high content of formic acid for the production of chemicals from xylose during the BIOCORE project⁴³⁹. Europe is also seen as leading the field in lignin removal, with several companies conducting pilot/demo activities on this step (e.g. BALI process).

Improve hydrolysis efficiency via tailored enzyme development

Each type of biomass typically requires a tailored enzyme cocktail for efficient degradation of sugar polymers. Enzyme cocktails are available for the most common biomass feedstocks, while for new or modified feedstocks enzyme cocktails are not yet available, resulting in less efficient hydrolysis and the need for high enzyme loadings. Industrial actors are investing effort to improve current enzymatic cocktails, which are mostly based on fungal cellulases from well-known cellulolytic fungal strains. In addition, there are many activities in the development of enzymes from a variety of microorganisms, including bacteria and less known fungal strains.

Introduce processes that are flexible with respect to feedstock

The development of production facilities where several feedstocks can be used could mitigate the risks associated with feedstock availability, including seasonality and price volatility impacts. However, biomass fractionation and pre-treatment processes are usually specifically tailored to each biomass type. Fractionation and pre-treatment approaches that could be applied to several biomass feedstocks with relatively small adjustments are needed. In addition, separation of inert materials and biomass washing can be adopted to reduce inert content and technical problems during biomass processing: this aspect also impacts on the ability of the plant to be fed with multiple different feedstocks.

8.1.2. Conversion from the sugar platform to a useful product

Increase product yields and reduced by-product formation in biological processes

Applies to the following case studies: PHAs, succinic acid, farnesene, BDO, isobutene, acrylic acid

Due to metabolic constraints, the yields of products in a biological process are normally subjected to a maximum, which is difficult to improve. In addition, feasible energetic and redox balances in microorganisms typically result in the formation of multiple products during fermentation of sugars. The toxicity of products to the microorganisms results in low product concentrations in the fermentation broth. As a result, downstream product isolation and processing have a high energy demand, leading to high production costs. These barriers can be addressed by developing advanced strains with higher yields and higher tolerance to the product of interest. However, due to metabolic constraints, the improvements using this approach are limited. Therefore, process technologies that overcome this limiting factor for example advanced reactors with “in-situ” product removal are needed. At laboratory scale, some technologies have been developed, that need to be demonstrated at pilot scale (and beyond).

Lower energy demand for product separation

Applies to the following case studies: BDO, LC-ethanol to PE or adipic acid, isobutanol to isobutene

⁴³⁹ <http://www.biocore-europe.org/>

High energy demand for the product separation stages is an overall constraint for processes in which the products are formed in aqueous solutions and normally at low concentrations. For example, the production processes for volatile alcohols use distillation for separation and purification of the products, in order to meet the requirement purity specifications of the downstream application. Distillation is a technique that requires high energy inputs, however alternative techniques are being developed at laboratory scale and are expected to be more energy efficient and/or selective in the products separated. Upscaling and demonstration of alternative advanced separation techniques is needed to validate them and bring them to commercialisation. Product separation energy therefore remains a key research gap – a fact agreed upon by all our workshop attendees.

Higher purity of the lignocellulosic sugars to be used in chemical processes

Applies to the following case studies: FDCA

In lignocellulosic streams, the sugars mix with the other components from the biomass and those chemicals added or produced during the pre-treatment. For chemical catalysis, pure sugar streams are needed in order to prevent by-product formation or inefficient catalysis (plus catalyst poisoning). The current technologies for sugar purification, such as chromatography, are still very expensive and need further development to be applied cost effectively at large scale. In general for the chemical catalysis of sugars, reactor designs need improving and to be made cheaper, along with the development of new catalysts that are more selective and robust to input quality variations. These remain research gaps holding back to the development of chemical routes from sugars.

8.1.3. Upgrading of any intermediate products to polymers

Develop purification processes to obtain high purity monomers

The purity of monomers in a polymerisation process is crucial (typically > 99.9% purity is required), otherwise the resulting polymers have inferior properties. This purity demand is usually higher than for other applications. This implies that purification processes for building blocks that are to be used in polymers need to be developed. The challenge of meeting the purity specifications can be harder for second generation feedstock pathways and may need to be considered also earlier in the process (e.g. during pre-treatment). Greater integration between the polymerisation technology and production of the monomer building blocks is required.

Development of new polymers

There is scope to improve the functionality and therefore the application range of sugar based polymers. For this materials research is needed in order to better understand and predict structure properties relations in order to develop materials for a wide range of applications. Research issues such as high temperature properties, impact behaviour, mechanical properties and rheological behaviour need to be addressed.

Scale up of polymer production

To be competitive with existing products, sugar based polymer production needs to be scaled-up, and possibly integrated with monomer production. This will include separation and polymerisation steps. Some polymers only partially bio-based currently, since the bio-based monomers are unavailable at scale.

Downstream processing may also require development and scale up, where the polymer products are not drop-in replacements for existing petrochemical products.

8.1.4. Process integration

Better process integration is required between the pre-treatment, enzymatic hydrolysis, fermentation and downstream processing sections of a bio-based process for lignocellulose and waste feedstocks. This remains a key research gap, since currently most technologies are developed independently from each other, and since many different disciplines are needed to effectively study this integration. Small changes in feedstock or pre-treatment can have really big effects on downstream processes. Only very few combinations of technologies (and feedstock) have made it to commercial scale to date.

Processes where sugar solubilisation and fermentation are linked, without (or a very reduced) need for external enzymes, also require further development, such as consolidated bioprocessing (CBP) or simultaneous saccharification and fermentation (SSF) processes. These have potential to be more economically viable, as they should be able to minimise enzyme use, lower capital costs, improve processing times and enable efficient feedstock use.

Particular R&D attention is also needed further downstream, on the integration of biotechnological conversion steps with chemical conversion steps, in order to produce target products or monomers of sufficient purity. Up to this point, R&D programmes are often either focussed on either biotechnological conversion or on chemical conversion, without focusing on the interfaces. These interfaces are crucial for a large number of theoretical pathways, but remain a research gap that needs addressing, then ultimately demonstrating at full-scale biorefinery level.

8.2. Non-technical barriers and gaps in support policy

8.2.1. Assessment of non-technical barriers

Besides the technical development of each pathway and its component parts, there are numerous other barriers faced in bringing a technology and supply chain to commercialisation. The Bio-TIC project (2014) has done considerable work recently in identifying regulatory and non-technological hurdles that may inhibit innovation and prevent the realisation of the market and technological potential of industrial biotechnology. Three of the key Bio-TIC sectors are advanced biofuels, biochemical building blocks and bioplastics (alongside bio-surfactants and CO₂ utilisation). The full list of sugar platform down-stream options in this study (alcohols, acids, polymers) is therefore also covered under the Bio-TIC scope, and hence the results from Bio-TIC are highly relevant for this study.

The Bio-TIC non-technological roadmap is based on an extensive literature study and the subsequent stakeholder discussion of its findings during eight regional workshops and more than 60 expert interviews. Several high-level barriers were highlighted throughout this process, as shown in Table 16, which would generically apply across the all sugar-based pathways.

In terms of issues specific to each sector, the following key issues have been highlighted⁴⁴⁰:

- **Biofuels:** the “food vs. fuel” debate and its effects on public acceptance, environmental concerns and ultimately the loss of future legislative support have ‘*created a trauma in the biofuels sector and hindered the development of advanced biofuels*’, with limited public support for financing demo or first commercial plants in Europe. Feedstock prices are high, partially because of regulations, tariffs and certification schemes, and collection infrastructure for many agricultural residues is missing.
- **Bio-chemicals:** the core issue appears to be the lack of general interest in production of bio-based chemicals building blocks, whether it is expressed by low levels of investment, few and unstable policies, or a lack of market incentives for biochemicals. Demonstration scale-up activities are expensive, and in many cases not being carried out due to the lack of a clear economic case versus the fossil chemical counterfactual.
- **Bio-polymers:** the business case for bio-based plastics is mainly faced with problems related to price (vs. fossil substitutes), a lack of critical mass due to immature value chains, and no real regulatory support to foster its competitiveness. A lack of recycling systems for new polymers, poor public awareness and the need for clear standards/definitions are also hampering the sector.

Based on a series of workshops and interviews conducted during 2013-2014, the Bio-TIC project has also identified and proposed solutions for key market entry barriers, going beyond recommendations already formulated by other initiatives and projects on biobased products, and preparing recommendations and an action plan for policy makers. The actions identified will be further developed (detailed description of the action, possible impact, how and who to implement, etc) within the final roadmaps, due to be published in mid-2015.

⁴⁴⁰ http://www.industrialbiotech-europe.eu/wordpress/wp-content/uploads/2014/04/Executive-Summary-of-Non-Technological-Roadmap_Draft-2_April-2014.pdf

Table 16: Overview of main non-technological hurdles (Bio-TIC, 2014)

Barrier category	Barrier	Issues
Feedstock related barriers	Logistics: securing large quantities of biomass all year round	Seasonality of biomass cropping versus need of continuous feedstock supply Inefficient transport and distribution of biomass Inefficient recovery systems for (bio)waste
	Feedstock at affordable prices	Costs of feedstock produced in Europe are too high compared to other regions Varying feedstock prices (High) import costs for certain types of feedstock No commonly accepted "sustainability" certification system
Investment barriers & financial hurdles	Capital requirements	Limited availability of public R&D funding Limited public support for scale-up activities Limited access to finance for spin-offs and start-ups Limited access to finance for SMEs Limited financial support for new production facilities
	Industrial biotech perceived as sector with high investment risk	"Investment payback" period is too long Lack of visible tangible products and blockbusters Lack of investor confidence
Public perception & communication	Poor public perception and awareness of industrial biotech and biobased products	Advantages of biobased products are not visible enough Negative messages in the media on GMO and biofuels influence perception of industrial biotechnology
Demand side policy barriers	Absence of incentives or efficient policies	No framework to promote biobased products Lack of a "green public procurement" policy promoting biobased products Wide variety of ecolabels and no uniform standard present for sustainable and biobased products
Other barriers	Human resources	Lack of personnel with right skills and curricula
	Collaboration efficiency	Insufficient cooperation and knowledge exchange between the parties in the value chain Difficulties to establish operational alliances between industry and academia Regional funding conditions hinder establishment of international networks
	Intellectual property	High patent costs hinder start-ups and SME's Lack of harmonised IP regulation
	Sustainability	Difficulties in implementing the sustainability agenda and life cycle thinking in policies, and lack of coherent policy framework for sustainability No general consensus on important definitions for the bioeconomy
	Other policy barriers	Hampered implementation of strategic approach

Each of the high-level and sector-specific barriers already has a list of possible solutions, as compiled by Bio-TIC, and a discussion of enablers seen as likely to help promote the sector (e.g. rising fossil oil prices, reuse of existing infrastructure, recycling and waste management targets, valorisation of co-products). These are discussed in detail in the Bio-TIC documentation⁴⁴¹, and hence this study will not repeat the exercise of identifying mitigating actions (one of the primary purposes of Bio-TIC).

⁴⁴¹ <http://www.industrialbiotech-europe.eu/bio-roadmaps/non-technological/>

8.2.2. *Prioritisation of non-technical barriers*

Based on the table of non-technical barriers discussed above, the combined experience of the project team, and the feedback received during the two project workshops, the barrier categories are prioritised in order of (decreasing) importance:

1. Demand side policy barriers (most important)
2. Public perception & communication
3. Investment barriers & financial hurdles
4. Feedstock related barriers
5. Other barriers (least important)

A discussion of the barriers being addressed by current EU policy and funding measures is given earlier in Table 7. Except for public perception and communication, there is good coverage regarding how the designed **biofuel** policies/measures theoretically match the key barriers above – however, stakeholders have indicated that in practice, some of the key policies/measures have suffered uncertainties in their delivery and longevity (e.g. RED with ILUC), are too heavily focused on R&D (H2020, EIBI) or are yet to be implemented fully to bring forwards construction of new projects (BBI, NER300). Very few of the policies/measures impact upon the **biochemicals** sector – potentially only H2020 and BBI.

There is therefore scope for the current set of EU policies and policy measures to be improved – workshop attendees provided a large number of suggestions around some high-level common themes, as summarised in the following Section.

8.2.3. *Potential policy improvements*

The consistency of policy, the ‘quality’ of governance including open dialogue with stakeholders and the public, plus the understanding and improvement (via innovation) of the economic competitiveness of bio-based routes, will all be the key factors in shaping a successful bio-economy⁴⁴². This final section discusses how EU policies and measures could potentially be improved to overcome the key barriers, and hence accelerate the deployment of sugar-based pathways. The evidence is based primarily on a synthesis of stakeholder inputs and debate from the two study workshops.

Level playing field for sustainable biomass use in the bio-based economy

The EU has outlined its bioeconomy strategy, and established the Bioeconomy Panel and Bioeconomy Observatory, representing major steps forward in recognising and promoting the benefits of a bioeconomy in Europe⁴⁴³. However, policymakers are yet to set out concrete policy measures or financial support mechanisms that can be invested upon with this bioeconomy vision.

Stakeholders see that the ultimate goal would be to create a level-playing field for the sustainable valorisation of biomass resources to bio-based chemicals & materials, bioenergy/biofuels and food/feed (i.e. the whole bioeconomy). Given the cross-cutting nature of the bioeconomy, such measures would

⁴⁴² <http://www.mdpi.com/2071-1050/5/6/2589/pdf>

⁴⁴³ <http://ec.europa.eu/research/bioeconomy/>

require the full support of the different DGs within the Commission. As stated within the EU Bioeconomy strategy document⁴⁴⁴;

‘Biorefineries should adopt a cascading approach to the use of their inputs, favouring highest value added and resource efficient products, such as bio-based products and industrial materials, over bioenergy.’

Currently, however, the policy framework in Europe is still mainly focused on biofuels. There are no regulatory support instruments to foster the competitiveness of sugar-derived chemicals or materials. Moreover, EU policy does not set binding targets for biobased chemicals and materials. This lack of a level playing field is seen as the major high priority gap within current European policy.

Stakeholders have called for a more specific approach to supporting bio-based chemicals, and whilst the industry generally regards mandates and similar regulatory mechanisms as the most effective means to mobilise the sector (and the required private investment), some are cautious of asking for mandates due to the additional uncertainty that they have the potential to create (such as with biofuels) – any mandates would have to be stable and long-term. Current bio-chemical businesses stand or fall on their own merits and product value propositions, in the absence of policy.

Provide long-term certainty in currently mandated sectors

The EU lacks long-term stable policies in the biofuel sector, due to there being no mandates for biofuels after 2020 (advanced or otherwise). A possible voluntary 2020 sub-target for advanced biofuels is still under discussion within the proposed changes to the RED. Advanced biofuel developers have also communicated that multiple counting has not been effective in bringing forward investment. Many are ignoring the impact of any 2020 sub-target, as it would expire in 5 years, and with planning and construction timescales, would only have a small impact on the viability of their projects. Stable targets for 2030 (or beyond) would be much more important to developers in being able to attract investment⁴⁴⁵.

The RED proposals also lack clear definitions for the ‘advanced’ feedstocks listed in ‘Annex IX’. These definitions are important to establish the list of material types and their volumes, ensure the policy is workable, allow the identification of potential risks and mitigating measures, as well as improve the consistency of definitions across the EU-28 Member States (which currently vary significantly)⁴⁴⁶. Ensuring the same advanced biofuels are eligible for the same support across the EU would allow efficient functioning of an internal market in advanced biofuels.

Policy support for sustainable biomass sourcing

This will help make sufficient bio-based resources (primary crops, residues/wastes and bio-based intermediates/commodities) available at the right time, place, quality and price to meet the EU’s bio-economy market demands. Supporting measures aimed at increasing feedstock availability can improve their contractibility and thus the likelihood of project development and investment. Key message 6 from the recent report by the European Bioeconomy Panel and the Standing Committee on Agricultural Research Strategic Working Group⁴⁴⁷ states that “*Development of a biomass strategy is desirable*”.

⁴⁴⁴ http://ec.europa.eu/research/bioeconomy/pdf/201202_commission_staff_working.pdf

⁴⁴⁵ https://www.gov.uk/government/uploads/system/uploads/attachment_data/file/277436/feedstock-sustainability.pdf

⁴⁴⁶ https://www.gov.uk/government/uploads/system/uploads/attachment_data/file/277436/feedstock-sustainability.pdf

⁴⁴⁷ http://ec.europa.eu/research/bioeconomy/pdf/where-next-for-european-bioeconomy-report-0809102014_en.pdf

Lessons should be learned from the bioenergy/biofuel sectors that have already successfully developed biomass trading and certification systems. Also, the development of certification systems for biomass sourcing would contribute to standardising the different voluntary reporting approaches used within the bio-chemicals sector at present. Guidance needs to be given regarding what accounting methodology should be used in each sector (e.g. energy/mass/price allocation and the level of system expansion/substitution) – this coincides with some of the recommended actions (A9.3, A9.4, 11.1) in the 2012 Bioeconomy working document⁴⁴⁸.

EU-wide biomass communication strategy

The current public perception of using biomass for applications other than human food production is generally negative, due to the experience with 1G biofuels. A biomass communication based on scientific facts should be started by the EC to help more positively influence the public perception on using biomass for non-food applications. This could list the different roles for biomass within the economy, the numerous advantages (e.g. more rural jobs, GHG savings, energy security) alongside the risks (and how they can be mitigated), in a fair and balanced manner. This coincides with one of the recommended actions (A5.3) in the 2012 Bioeconomy working document⁴⁴⁹.

Policies to disincentivise fossil products

The EU can improve the competitiveness of bio-based products, by acting to reduce the consumption of fossil alternatives or increase their price. An example is given by the current EU legislation on reducing use of lightweight plastic bags by 50% by 2019, and 80% by 2025 (or else introducing mandatory charging), along with allowing Member States to ban non-biodegradable plastic bags (as Italy and France have already done)⁴⁵⁰. These measures are expected to pave the way for a large uptake in compostable shopping bags⁴⁵¹. Taiwan also banned distribution of free fossil plastic bags in 2003, and introduced minimum bio-based percentages in plastic, leading it to become the world's largest market for PLA.

Improve access to capital and loan guarantees

From 2007-2013, a guarantee facility (RSI, Risk Sharing Instrument⁴⁵²) was available generally to European SMEs under the Competitiveness and Innovation framework Programme (CIP) – this has been replaced with the InnovFin Guarantee Facility⁴⁵³. Stakeholders have urged the EU to develop **dedicated** programmes aimed at providing guarantees for innovative bio-technologies and processes, and thus to facilitate business **access to finance** (as in the US and Brazil). For these large scale industrial complexes, subsidies in terms of grants do not effectively address the largest part of the investment. Borrowing can be difficult for SMEs, however, particularly if they lack collateral or if they do not have a long-enough track record or credit history. Supporting SMEs in obtaining loans from banks through guarantees (provided by public, private, or mutual guarantee institutions) can help compensate for these risks, and improve the competitiveness of the resulting project. At the same time, large industries will benefit from loan guarantee programmes, given the scale of the investments required in bio-refining.

⁴⁴⁸ http://ec.europa.eu/research/bioeconomy/pdf/201202_commission_staff_working.pdf

⁴⁴⁹ http://ec.europa.eu/research/bioeconomy/pdf/201202_commission_staff_working.pdf

⁴⁵⁰ <http://www.euractiv.com/sections/sustainable-dev/europes-historic-moment-plastics-bags-contested-industry-advocates-310336>

⁴⁵¹ http://en.european-bioplastics.org/wp-content/uploads/2014/pr/EUBP_PR_EU_approves_bag_reduction_141125.pdf

⁴⁵² http://www.eif.org/what_we_do/guarantees/RSI/

⁴⁵³ http://www.eif.org/what_we_do/guarantees/single_eu_debt_instrument/innovfin-guarantee-facility/index.htm

However, only being “green” is not necessarily a sufficient driving factor for major companies to support the development of the industry (only some are willing to pay a premium); many demand that product performance must be better and/or costs should be lower than the fossil alternatives. This is particularly challenging at the moment, with the dramatic drop in crude oil prices likely making most bio-based products economically uncompetitive, hence hindering investment.

Simplified funding mechanisms

Schemes that are too complex, bureaucratic, detailed or lengthy (e.g. 3 years) discourage industry commitment and investor engagement. Large proposal forms and procedures also present significant difficulties for SMEs due to the high time investment required. These are other important barriers for the development of new production facilities that have been mentioned by stakeholders, together with the Intellectual Property related issues when participating in cost-shared and supported actions.

The BBI is heavily focused on advanced value chains, from lignocellulosic feedstock, forestry, agricultural residues, organic waste and paper/pulp biorefineries. Biochemicals stakeholders have said that BBI funding, whilst significant, is therefore too focused on LC sugars (and needs to be opened up to 1G sugars) – there is a need to demonstrate and commercialise new biochemical technologies and integrated biorefineries with 1G sugars first, before making the difficult leap to LC sugars. Demonstrating new processes on new feedstocks is too much risk, and many lignocellulosic varieties of products will not be ready for commercial investment before 2020.

Report Appendices

- A. Literature survey
- B. Assessment of suitable feedstocks
- C. Product descriptions
- D. Potential impacts of lower crude oil prices
- E. Safety issues regarding the use of micro-organisms in biofuels processing
- F. Development of criteria for assessing socio-economic impacts on local communities
- G. Glossary of acronyms
- H. References

Appendix A - Literature survey

The teams at WUR, RE-CORD and E4tech are significant contributors to the scientific literature surrounding lignocellulosic biofuels, sugars, micro-organism fermentation and bio-refineries, and through our networks, are well aware of the state-of-the-art developments occurring across Europe, and key pieces of literature relevant to this study.

We therefore started the project by conducting a brief literature survey, collecting together documents from within the consortium, the wider academic literature and industry reports. We have collected influential documents written before 2010 (where still relevant), but focused on sources from 2010 onwards, given the pace of change in the industry in recent years. This Chapter summarises the key sources available, organised by theme.

Feedstock characterisation

We collected numerous academic papers on the properties of different individual feedstocks, however, from a meta-analysis viewpoint, the following studies are most relevant:

Saidura et al. (2011) A review on biomass as a fuel for boilers contains an in-depth characterization of different biomass, with the biochemical data used for sense-checking and gap filling in our feedstock Chapter.

Roderick (2013) A review of biomass utilization in a Northern European context analyses and suggests the most suitable lignocellulosic feedstocks for biofuel production.

García et al. (2014) Evaluation of different lignocellulosic raw materials as potential alternative feedstocks in biorefinery processes shows different pre-treatment technologies, and classifies several alternative lignocellulosic materials according to their type and origin. They use the chemical characterisation data to propose the proper exploitation as biorefinery feedstocks.

Pre-treatment technologies

A literature review of the possible pretreatment processes for lignocellulose, and a comparison of their key advantages and disadvantages, can be found in *Harmsen et al. (2010) Literature review of physical and chemical pretreatment processes for lignocellulosic biomass*

Chiaromonti et al. (2012) Review of pretreatment processes for lignocellulosic ethanol production, and development of an innovative method. This paper reviewed the main options available in biomass pretreatment for LC ethanol production. Autohydrolysis and steam explosion were then selected for further investigation. Experimental work was carried out on batch scale reactors, using *Miscanthus* as biomass feedstock, examining the effects on sugar solubilization and degradation products generation. A new process using only water and steam as reacting media was developed, experimentally tested, with inhibitor results comparing favourably to those achieved by the autohydrolysis and steam explosion processes.

Chiaromonti et al. (2010) 2nd generation lignocellulosic bioethanol: is torrefaction a possible approach to biomass pretreatment. A new approach to biomass pretreatment for LC ethanol could be mild torrefaction, since improved grindability of fibrous material reduces energy demands, and torrefaction opens the biomass structure improving enzyme access for hydrolysis. The aim of the preliminary experiments was to

achieve a first understanding of the possibility to combine torrefaction and hydrolysis for LC ethanol, and to evaluate it in terms of sugar and ethanol yields. Results showed that torrefied biomass can be enzymatically hydrolysed and fermented into ethanol, with yields comparable with grinded untreated biomass and saving electrical energy.

Bioplastic building blocks

Harmsen et al. (2014) Green building blocks for biobased plastics is the most recent paper on the topic, giving an overview of possible routes to produce the main plastics from biomass, covering polyolefins, polyesters, polyamides, polyurethanes and rubbers. The paper gives information on which building blocks are involved, how the conversion from one to the next building block can be done, which companies are developing and investing, plus the stage of development.

Harmsen & Hackmann (2013) Green Building Blocks for Biobased Plastics is an older version of the previous paper, but containing slightly more info on the companies involved. These two papers do not only cover sugars as feedstock, but most of the processes discussed do start from sugars, starch or cellulose.

de Jong et al. (2012) Biobased Chemicals - value added products from biorefineries focusses not only on sugars, but contains relevant info on the status of various biochemicals. This IEA Bioenergy Task 42 report was one of the main literature sources used in deriving our product list of 200+ fuels, chemicals and polymers, and also contains a non-exhaustive list of mainly US and EU companies (slightly outdated) working on each product considered. The same authors replicated much of the data from the IEA Task 42 project in writing *de Jong et al (2012) Product development in the biobased chemicals arena*.

An older paper underlying these studies above is *Star-COLIBRI (2010) "D 2.1 Background information and biorefinery status, potential and Sustainability: Task 2.1.2 Market and consumers; Carbohydrates"*. This report focuses solely on carbohydrates, but is a little outdated in places.

Older papers also include *Bozell & Petersen (2010) Technology development for the production of biobased products from biorefinery carbohydrates—the US Department of Energy's "Top 10" revisited*, which presents an updated evaluation of potential target materials using a similar selection methodology to the original US DOE study in 2004, as well as providing an overview of the technology developments that led to the inclusion of a given compound on the list. This list has been used as one of the key sources in selecting the 20 or so products discussed in the later sections of this report.

VanHaveren et al (2008) Bulk chemicals from biomass focuses mainly on the potential for fossil substitution at the Port of Rotterdam, giving a (now outdated) snapshot of product prices, markets and developers.

De Jong et al. (2014) Lignocellulose-based chemical products is a book chapter, rather extensively covering the variety of different chemical routes and processes. This book chapter also contains a list of industries working on cellulose based chemicals, including present status.

Two book chapters describing bio-alcohol production processes, with a focus on C4 alcohols including n-butanol and 2,3-butanediol, have also been examined: *Lopez-Contreras et al. (2012) Novel Strategies for Production of Medium and High Chain Length Alcohols* and *Lopez-Contreras et al. (2010) Production of longer-chain alcohols from lignocellulosic biomass: butanol, isopropanol and 2,3-butanediol*

Scott et al. (2013). "Rules for the bio-based production of bulk chemicals on a small scale" defines which products and processes in the petrochemical industry have high variable and capital costs, and hence which biomass feedstocks and conversion processes could be used to reduce costs.

Weastra (2013) “WP 8.1. Determination of market potential for selected platform chemicals” provides a detailed analysis - for itaconic acid, succinic acid and FDCA - of their current market volumes, value, producers, current and future applications, competitiveness and market potential. This is also accompanied by a summary slidepack.

Babu et al. (2013) “Current progress on bio-based polymers and their future trends” looks at status, market sizes, capacity by producer and expected plans for PLA, PHAs, PBS, PE, as well as starch and cellulose polymers.

Although not the main focus of the study, Kretschmer et al. (2013) “Recycling agricultural, forestry & food wastes and residues for sustainable bioenergy and biomaterials” contains a several useful middle chapters on the status of biorefineries in Europe and worldwide, discussing (and tabulating) producers, capacities and their development status, as well as discussing which bio-based chemicals have greatest potential.

Sustainability

Bos et al. (2012) *Accounting for the constrained availability of land. A comparison of bio-based ethanol, polyethylene, and PLA with regard to non-renewable energy use and land use.* This study compares non-renewable energy use, direct land use, and greenhouse gas emissions from PE, PLA and sugarcane ethanol.

Bos et al. (2010) “Sustainability aspects of biobased applications: Comparison of different crops and products from the sugar platform” contains all the background data used in the Bos et al. (2012) paper.

Hong et al. (2013) *Impact of cellulase production on environmental and financial metrics for lignocellulosic ethanol* evaluates life cycle emissions and cellulase production costs for bioethanol production, considering on-site and off-site enzyme production options, and using mass and energy balances in AspenPlus.

Falano, T.O. (2012) “Sustainability Assessment of Integrated Bio-refineries” conducts and compares full LCA analyses on bio-chemical and thermo-chemical routes to ethanol.

Rettenmaier et al. (2013). “Environmental sustainability assessment of the BIOCORE biorefinery concept (D 7.5)” assesses the environmental impacts of the Organosolv process biorefinery, based on taking pilot data of the concept and scaling up to mature technology in 2025. The largest influence on the LCA was identified as the choice of product portfolio, with greatest benefits achieved by avoiding fractionation into small molecules.

Policy and industry development

Nova (2013) “Market study on Bio-based Polymers in the World: Capacities, Production and Applications: Status Quo and Trends towards 2020” is the first market study to gather data across the whole range of products and companies active in the bio-based plastics sector. This is based on earlier work by Nova (2012) “World-wide Investments in Bio-based Chemicals”. A similar analysis identifying the current market and strengths/weaknesses of the Netherlands was also conducted by Nova (2013) “Market Developments of and Opportunities for bio-based products and chemicals”

Extensive surveying has also been conducted in the US, but with a wider focus on the whole bio-economy, as reported in USDA (2011) “Biobased economy indicators”.

AEBIOM (2013) “European Bioenergy Outlook” provides statistical data by Member State for biomass supply, and biomass consumption in heat, electricity and transport usage, plus additional insights into the

biogas and pellets markets. Bacovsky (2013) “*Status of Advanced Biofuels Demonstration Facilities in 2012*” has also collected a database of EU 2G biofuel plants.

European Commission (2012). “*Innovating for Sustainable Growth: A Bioeconomy for Europe*”, is one of the key strategy communications that impacts the area of European biochemicals and bioplastics, although stops short of specific policy actions.

Maniatis & Chiamonti (2012) Framework and perspectives of industrial lignocellulosic ethanol deployment: Introduction to the 1st International Conference on Lignocellulosic Ethanol. Within the Renewable Energy Directive (RED), the EU adopted sustainability criteria and counting rules for biofuels to be used in its market. This paper presents perspectives of industrial lignocellulosic ethanol deployment within the European context.

Balan et al. (2013) Review on US and EU initiatives toward development, demonstration, and commercialization of lignocellulosic biofuels. The review covers and compares the developments in the conversion technologies for lignocellulosic biomass to advanced biofuels in the EU and US, and provides a comprehensive list of the most relevant ongoing development, demonstration, and commercialization activities within various companies, along with the different processing strategies adopted by these projects.

Biorefinery concept

IEA (2013) TASK 42 Biorefineries: Co-production of Fuels, Chemicals, Power and Materials from Biomass. This final task report was prepared for the ExCo71 meeting in South Africa in May 2013, outlining the progress against the work programme objectives – including biorefinery classification system, identifying the most promising bio-based products, assessing biorefinery status, and providing sustainability guidance.

Jungmeier et al. (2013) Biofuel-driven biorefineries, written for IEA task 42, gives a series of case study information and data for a selection of promising biorefinery concepts, with a focus on those able to produce large volumes of road biofuels by 2025.

Two reports from the StarColibri project present a vision and a roadmap on the development of biorefineries in Europe: *StarColibri (2011) Joint European Biorefinery Vision for 2030* and *StarColibri (2011) European Biorefinery Joint Strategic Research Roadmap 2020*

2nd generation biorefineries are also studied in the Biocore project, with papers collected including *BIOCORE (2012) D1_1 Availability of lignocellulosic biomass types of interest in the study regions*, *BIOCORE (2012) D1_2 Assessment of procurement costs for the preferred feedstocks* and *BIOCORE (2014) Findings from case study*

Appendix B - Assessment of suitable feedstocks

Feedstock availability is crucial for the feasibility and economic viability of every biomass processing activity, irrespective of the final product (heat, power, transport fuel or chemicals) or whether an integrated biorefinery or standalone conversion pathway is used. However, not every feedstock (or mix of feedstocks) can be used as an input to every pre-treatment technology in the sugar platform. Some technologies are more flexible than others, but for each technology converting feedstock into sugars, there is a range of biomass feedstock characteristics that are allowable. We note that links between feedstock characteristics and the technical requirements of the pre-treatment technology are usually quite poor, i.e. this area is under researched.

These biomass characteristics typically include physical aspects such as volumetric and energy densities, moisture content and particle size, along with chemical aspects such as the make-up of cellulose, hemicellulose and lignin, plus ash, trace metals, sulphur and nitrogen contents. These requirements often exclude certain feedstock types from being used in certain pre-treatment technologies (Harmsen et al., 2010) – with the high availability of cellulose and hemicellulose, and low levels of lignin, being the key determinants of sugar and downstream product yields.

This Chapter therefore sets out to identify the different feedstock types to be considered for analysis, across a range of lignocellulosic biomass types (woody and grassy), arable food crops (starch and sugar-based), agricultural residues (straws) and solid organic wastes. Typical characterisation data has then been collected for each feedstock, along with key criteria for each pre-treatment technology. We then discuss the suitability of each feedstock group for use in the different pre-processing technologies.

Structural composition of biomass

Solid biomass feedstocks are primarily made up of carbohydrates, derived from the transformation of atmospheric carbon dioxide into simple sugars within plants and photosynthetic microorganisms. The sugar platform concept therefore focuses on the breaking down of biomass feedstocks into their different component sugars to allow the production of biofuels and biochemicals.

Biomass contains varying amounts of cellulose, hemicellulose, lignin and small amounts of lipids, proteins, simple sugars and starches. The combination of cellulose, hemicelluloses, and lignins is called 'lignocellulose', which comprises around half of the plant matter produced by photosynthesis and represents the most abundant renewable organic resource on earth (Saidura et al. 2011), with a worldwide annual production of at least 10 billion tonnes/yr (Sánchez and Cardona, 2008). The energy is stored in the structural bonds within the biomass, and can be harvested for energy and/or chemical production.

Cellulose is made up out of long chains of glucose polymers and forms the primary cell wall of green plants. Hemicellulose is made up out of shorter molecular chains consisting of a mixture of heterogeneous branched sugar monomers such as xylose and mannose. Lignin is a complex molecular compound which fills the spaces between the cellulose and hemicellulose, thereby giving structural strength to plants. The detailed structure of lignocellulose is shown in Figure 36.

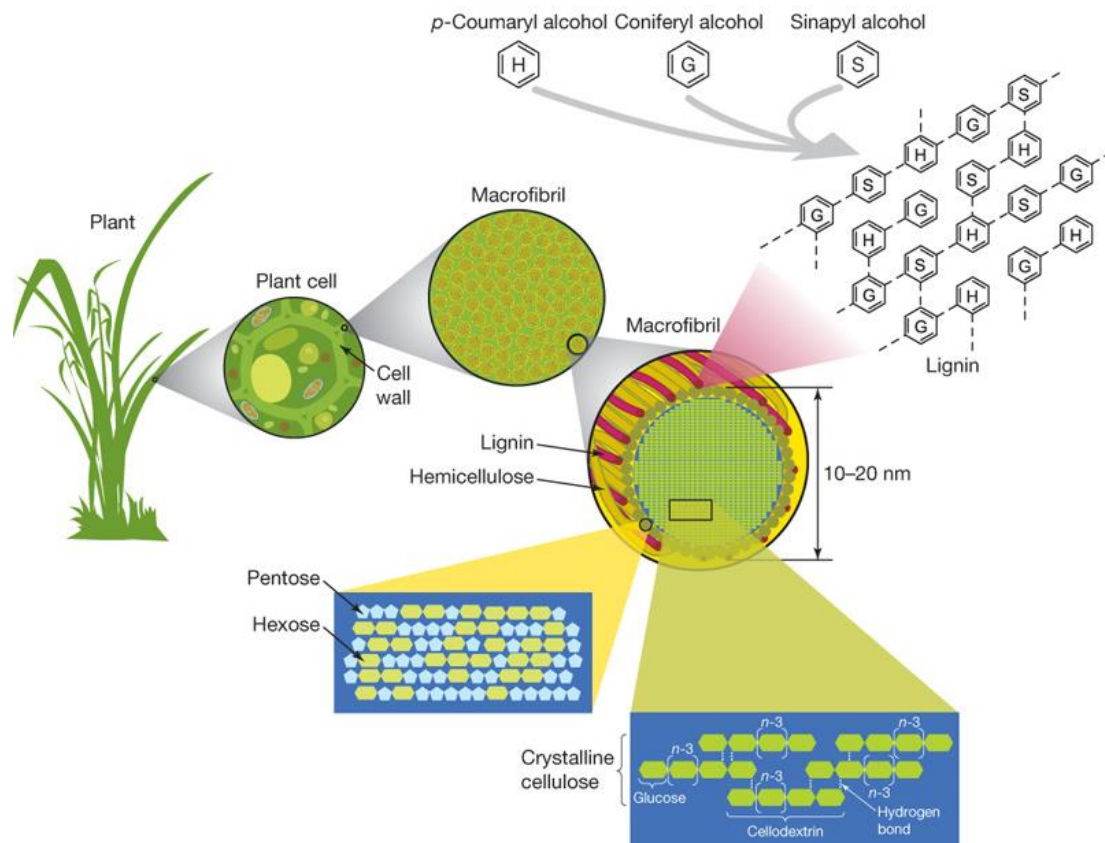

Figure 36: Structure of hemicellulose (Potters et al., 2010)

Cellulose, hemicelluloses and lignin are strongly intermeshed in lignocelluloses and are chemically bonded by non-covalent forces or by covalent cross linkages. Biomass usually also contains smaller amounts of other compounds such as ash and minerals and a fraction of water. The levels depend on the type of biomass, the soil, growing conditions and time of harvest.

The molecular composition of plant matter is an important determinant for the efficiency of biomass processing. Woody biomass is composed of firmly bound fibres with high lignin content and is well suited for thermal conversion. Plants which can be harvested yearly, e.g. grasses, have more loosely bound fibres and a lower lignin content (Roderick, 2013). The structural analysis of biomass is particularly important in the development of processes for producing other fuels and chemicals, especially in the sugar platforms and in the study of combustion phenomenon. It also plays an important role in the estimation of the higher heating value of biomass. In fact, as lignin is less oxidized than hemicelluloses, it has a higher heating value and this typically translates to lower heating values of herbaceous biomass as compared to woody biomass or some agro-industrial residues, such as olive press cakes. The lower lignin content also affects, to some extent, the combustion speed (Karampinis, 2012).

Biomass characterisation

In this section, we analyse different suitable *sugar containing feedstocks*, describing their biochemical and chemical characteristics and their impacts on pre-processing techniques. We have focused this analysis on several different biomass types available within Europe.

The main sources of biomass considered are forestry, purpose-grown energy crops, and the residues from agriculture, industry and wood processing (Saidura et al. 2011). Energy crops include woody and grassy perennial crops, short rotation forestry as well as agricultural crops grown for their calorific value (not food or feed). Residues include a wide range of biomass materials that are made as by-products, residues or wastes from other processes, operations or industries such as straw, forestry thinnings, wood shavings, shells, husks and other wastes (NREL, 2014). Many of these have a valuable energy content that can usefully be exploited (Hogg et al. 2007).

Table 17 presents typical biochemical and chemical characterisation data of the different biomass types considered in this study. These values are based on average example feedstock data, although noting that many of the values will show very considerable variability between different samples.

The biochemical analysis displays the dry weight percentage of each of the lignocellulosic components (cellulose, hemicellulose and lignin), and the sum of simple C6 and C5 sugar seen as structural polymers constituents. This structural analysis is particularly important in the development of processes for producing biofuels and chemicals, especially as the sugar platform aims to maximize the utilization of input biomass. ECN (2014) has the most complete biochemical dataset, named Phyllis2, usually covering cellulose hemicellulose and lignin, and the sum of C5 and C6 sugars contained in the biomass. For the sugar analysis, ECN uses the following formulae (Goering and Van Soest 1970):

- *Cellulose = glucan*
- *Hemicellulose = sum C5 + sum C6 - glucan - rhamman*

We note that the IEA (2014) databases do not give information about the biochemical analysis. However, Saidur et al. (2011) gives some additional information about the composition and proportions of the lignocellulosic components in different biomass and residues, hence in this review was used to compare and fill in the data missing from Phyllis2 (ECN, 2014). Some of the C5 and C6 sugar data is still however missing for the less common feedstocks.

The ultimate analysis and the ash content data were taken from both Phyllis ECN and IEA databases. This analysis gives the chemical composition of the biomass in percentage dry weight of carbon, hydrogen and oxygen (the major components) as well as sulphur and nitrogen.

Table 17: Biochemical and chemical characterisation of different biomass feedstocks (ECN, 2014; Saidur et al., 2014; IEA, 2014)

Feedstock group	Feedstock	Structural analysis (wt% dry)					Ultimate analysis (wt% daf)					Ash (wt% dry)	(Cellulose+ Hemicell) / Lignin
		Cellulose	Hemi-cellulose	Lignin	Sum C5	Sum C6	C	H	N	S	O		
Forestry	Spruce wood	45	21	28	6	63	49	5.9	0.17	0.02	45	0.9	2.3
	Pine	44	25	26	7	57	52	6.3	0.14	0.10	41	0.7	2.7
	Oak	40	20	25	18	40	50	6.3	0.61	0.09	43	1.4	2.4
	Birch	39	29	22	27	39	49	6.2	0.19	0.15	45	0.5	3.2
Forest industry residues	Bark	24	25	50	-	-	53	5.9	0.41	0.05	40	4.1	1.0
	Thinnings	37	18	34	-	-	51	5.7	0.59	0.09	42	1.5	1.7
	Sawdust & shavings	47	21	25	-	-	52	5.8	0.12	0.03	42	0.6	2.8
Short rotation forestry/coppice	Poplar	46	26	23	18	52	50	6.1	0.25	0.03	44	1.0	3.2
	Eucalyptus	43	23	25	11	52	51	6.1	0.27	0.04	42	1.6	2.6
	Willow	39	18	26	16	41	50	6.1	0.62	0.05	43	2.0	2.1
Grassy crops	Switchgrass	37	31	23	28	41	49	6.1	0.64	0.12	44	6.3	3.0
	Miscanthus	45	24	21	17	45	50	5.6	0.54	0.06	44	3.7	3.2
	Arundo donax	33	27	18	27	33	47	5.7	0.47	0.11	47	3.9	3.4
Food crops	Sorghum	39	24	9	-	-	49	5.8	0.91	0.07	44	6.9	6.7
	Corn	40	30	12	27	31	47	6.2	0.63	0.08	46	2.4	5.7
	Wheat	31	20	7	-	-	48	5.8	1.40	0.22	44	8.1	7.3
	Sugar beet	26	28	5	-	-	47	6.2	1.93	0.14	45	4.3	12.0
	Sugarcane	31	12	8	-	-	50	6.2	0.50	0.17	44	3.3	5.7
Agricultural residues	Straw	37	27	17	21	39	49	5.9	0.76	0.10	44	8.4	3.6
	Olive tree prunings	30	18	21	-	-	48	6.1	0.88	0.09	46	13.3	2.3
	Grape prunings	26	39	32	-	-	49	6.0	0.83	0.03	44	2.6	2.0
	Bagasse	39	31	18	24	41	49	6.0	0.55	0.10	44	5.8	3.9
Agroindustrial residues	Almond shell	36	29	29	29	30	50	6.2	0.89	0.04	43	3.7	2.3
	Hazelnut shell	26	30	46	-	-	49	5.9	0.77	0.46	45	1.4	1.2
	Walnut shell	23	20	43	19	26	52	6.2	0.80	0.08	41	1.8	1.0
	Orange peel	16	7	5	-	-	50	6.6	1.29	0.07	42	3.8	4.6
	Olive husk	23	25	47	-	-	51	6.9	1.22	0.07	41	5.5	1.0
Others	Macroalgae	9	7	0	-	-	31	4.3	2.00	1.50	38	30.0	NA
	Paper pulp/sludge	59	17	14	12	68	42	5.5	0.79	0.39	52	18.9	5.5
	Municipal solid waste	14	2	16	-	-	57	6.7	1.83	0.64	33	25.2	1.0
	Food industry waste	18	21	17	-	-	50	6.7	1.58	0.21	41	6.6	2.3

From data shown in Table 17, we can see that paper pulp/sludge contains the highest proportion of cellulose, at almost 60%. Macro-algae has minimal cellulose and lignin, but contains other carbohydrates such as alginates, laminaran and mannitol. The highest lignin proportions are found in residues such as bark and shells (up to 50%), whereas food crops typically have low lignin levels (5-12%).

Grassy energy crops on average contain less cellulose than woody energy crops, but they contain also less lignin (18-23% in grassy crops compared to 23-26% in woody energy crops). Residues from agriculture and agroindustry typically contain less cellulose (20-40%) than forestry or energy crops (30-50%).

Carbon, Hydrogen, Nitrogen, Sulphur and Oxygen percentages are quite similar in all the feedstocks, except for the “Others” category (containing macro-algae, paper pulp and wastes) which show elevated nitrogen and sulphur levels.

Forestry

Forestry is known to be a raw material with considerable potential for biorefineries because it is the most abundant and renewable source of lignocellulosic material in the world. Its three main components; cellulose (40–45%), hemicelluloses (20–30%), and lignin (20–30%) can all be used for further processing to new products. Today, the cellulose is principally used for pulp and papermaking, but will become increasingly important for the production of biofuels and biochemicals. Hemicelluloses have started attracting interest during the last decade as feedstock for bioethanol, biopolymers, emulsion stabilizers, and possible health applications. Lignin, as a residue, can also be used as raw material in other types of biorefinery (Krogell et al., 2013). Forestry is a very established industry, with stable prices and existing stands of trees that are typically harvested once every 30-100+ years.

Forestry industry residues

Forestry residues can arise from the maintenance and harvesting of forests, and from the processing of timber into wood products. The collection of forest thinnings and brash potentially represents a low cost source of under-exploited biomass, however, densities are typically low (transport costs can be high) and the feedstock is very heterogeneous in terms of its particle/piece size, moisture, ash and contaminants.

Forest industry residues are also included in this category, which may constitute up to 25% of the woody raw material – sawmills will typically produce 5–8% sawdust and 10–15% bark (García et al., 2014). The primary advantage of using forest residues for power generation is that an existing collection infrastructure is already set up to harvest wood in many areas. Companies that harvest wood already own equipment and transportation options that could be extended to gathering forest residues (EPA, 2007).

Separated bark is very high in lignin, but is also high in phenolics, fatty acids and resins suitable for production of chemicals. Sawmill cuttings, shavings and sawdust are typically very similar to the virgin wood, but dried, hence already have a wide variety of valuable uses in producing pellets (for sale to power or heat markets), use in animal bedding, manufactured wood products and onsite energy provision.

Woody energy crops

An energy crop is a vegetative species grown as a low-cost and low-maintenance harvest crop used for non-alimentary purposes, i.e., to produce biofuels, chemicals, cellulose pulp, boards, etc., or combusted using its energy content to generate electricity or heat (García et al., 2014). Energy crops can be classified as “woody”, such as poplar or willow, or herbaceous (“grassy”) such as switchgrass or miscanthus.

Woody energy crops are fast growing species of lignocellulosic plants. Willow and poplar are typically established in Europe as Short Rotation Coppice (SRC), and hence stems are harvested every 2-4 years, whereas Eucalyptus and other fast growing tree species are grown as Short Rotation Forestry, with clearfell harvesting every 8-20 years. Due to the faster growth, they typically have higher ash contents than Long rotation forestry, and have very high water consumption. SRC and SRF are not available in large volumes in Europe at present.

Grassy energy crops

Grassy energy crops are very fast growing species of herbaceous plants, usually with low lignin content. They are perennial non-woody crops that are harvested annually, though they may take two to three years to reach full productivity after establishment (NREL, 2014). As we can see in Table 17, even if the cellulose content of grassy energy crops (33-45%) is on average slightly lower than the woody energy crops (39-46%), the lower lignin content of grassy energy crops could be relevant for pre-treatment techniques which aim to separate lignin from the sugar precursors. However, these grassy energy crops are currently not available in large volumes, particularly in Europe, and are somewhat sensitive to frosts.

Agricultural residues

Agricultural crop residues are the plant parts, primarily stalks and leaves, not removed from the fields with the primary food or fibre product (NREL, 2014). Cereal crop farming activity generates very significant quantities of straw residues (over 60% of the total crop, dependent on water and nitrogen availability) that are usually left on the cropland to retain soil nutrients, or incinerated to prevent the spread of pests and uncontrolled fires. A certain fraction of the straw can be sustainably collected (leaving sufficient nutrients on the soil) and used within the biorefinery concept.

Agricultural crop residues are more easily treatable than wood (milder temperatures and lower reaction times), and the fermentation conditioning steps are less expensive and more efficient. Furthermore, they usually contain significant amounts of hemicellulose, whose exploitation becomes more profitable due to fractionation (García et al., 2014). The disadvantages of using these residues are high transport costs (due to low density), crop seasonality (which creates unreliable fuel supply), and competing uses for the residue (EPA 2007). For example, corn stover is normally used for animal feed or compost, and wheat straw is used for feed, animal bedding or power generation, all of which are established markets (EPA, 2007).

Horticultural waste refers to tree trunks, branches and trimmings generated during the maintenance and pruning of olive trees, fruit trees and vineyards, with a very variable volume and seasonality. Given the similarity of these horticultural feedstocks to wood, the study of their application within the biorefinery concept has been mainly focused on the production of pulp & paper, panels and bioethanol (García et al., 2014). However, accessing these feedstocks face barriers and added costs due to a lack of collection infrastructure or suitable harvesting equipment.

Agro-industrial residues

Agro-industrial residues include by-products or wastes such as those from the manufacture of olive and vegetable oils, processing of nuts, and wine industries. These are typically regional sources of carbohydrates and lignocellulose that, in the past, were treated as waste in many countries (Bocchini et al., 2011). In some countries, these materials are still disposed of, often without adequate treatment, causing environmental damage. In other countries, they are used to generate thermal energy by traditional (fires for cooking and heating) or modern methods (electricity and steam). The utilization of these materials as

sources of fermentable sugars in second generation ethanol production has been reported (Guitar, 2009), however, some feedstocks appear much more attractive than others due to the often high lignin contents.

Paper pulp

Pulp is a lignocellulosic fibrous material prepared by chemically or mechanically separating cellulose fibres from wood, fibre crops or waste paper (Gavrilescu, 2007). Pulp and paper processing converts fibrous materials, such as wood, non-wood and recycled paper, into pulp, paper and paperboard. Energy use in the pulp and paper industry is intensive and constitutes a significant portion of the pulp and paper production cost. Pulp and paper mills generate various quantities of energy-rich biomass as by-products, depending on mill technology, pulp and paper grades and wood quality. These materials are produced in all stages of the process: wood preparation, pulp and paper manufacture, chemical recovery, recycled paper processing and waste water treatment. These are all typically high in cellulose, but many pulps already have high-value uses or energy provision within the plant. Also, pulp based on recycled paper is typically high in toxic trace metals (e.g. Pb, Cd, Cu, Zn, Hg), which could limit down-stream applications.

Biomass suitability for pre-treatment

Lignocellulosic sources are seen as an important future source of renewable energy in the EU. However, the effective utilisation of lignocellulosic feedstock is not always practical because of its seasonal availability, variable quality and the high costs of transportation and storage (Lin et al., 2006).

Many physicochemical structural and compositional factors hinder the hydrolysis of cellulose present in biomass to sugars and other organic compounds that can later be converted to fuels & chemicals – this is because the carbohydrate polymers are tightly bound to the lignin, mainly by hydrogen bonds, but also by some covalent bonds. This presents an issue for many biofuel and biochemical routes - hence a pre-treatment step is required to make the biomass more suited for conversion (Roderick, 2013). The goal of pre-treatment techniques is to change the physical and chemical structure of the lignocellulosic biomass in order to make the cellulose more accessible and improve hydrolysis rates.

The use of feedstocks in a biorefinery context is therefore highly dependent on the choice of an appropriate pre-treatment method able to both release carbohydrates and maintain their molecular stability, since it has such a large impact on the yield and efficiency of the subsequent treatments (Garcia et al. 2014). **There are therefore significant benefits for biological conversion processes of selecting feedstocks with low lignin and high carbohydrate content** (Roderick 2013) – this therefore applies to the majority of the sugar platform.

In terms of the most suitable feedstocks for the extraction of sugars, the final column of Table 17 presents a common ratio in the wood treatment and waste decomposition sectors, that of “(Cellulose + Hemicellulose)/Lignin” as a useful measure of the likely bio-availability of the feedstocks sugars for fermentation (NCASI, 2004). Feedstocks with high values of this ratio therefore have low lignin and high sugar fractions, and hence are most likely to minimise the inhibition of hydrolysis enzymes (although this is also dependent on porosity and other factors), and produce the highest fractions of intermediate sugars and downstream products.

We note that the *Cellulose/Lignin* ratio is also commonly used. Untreated lignocellulose substrate (e.g. forestry feedstocks) will contain a ratio of cellulose to lignin of approximately 2:1 – and whereas woody biomass undergoing a pre-treatment aimed at removing lignin will generally increase the ratio to

somewhere between 4:1 and 10:1, the same biomass undergoing an acidic pre-treatment to remove hemicellulose will decrease the cellulose to lignin ratio below 2:1 (Qin et al., 2014).

There is therefore a relatively clear order of preference for biomass feedstocks being input into the sugar platform, based on the values of the (Cellulose + Hemicellulose)/Lignin ratio:

- Unsurprisingly, those feedstocks with the highest ratios are the food crops, and paper pulp, due to their high carbohydrates content and low lignin levels. These materials typically do not need pre-treatment techniques applied before undergoing hydrolysis to sugars (or straight extraction of sugars)
- Next most suitable are the agricultural residues (straw, bagasse) and grassy energy crops, although they have higher ash contents and lower densities
- Of medium suitability are woody energy crops and forestry, due to their higher lignin contents, but low ash and high cellulose fractions
- MSW, industrial food wastes, orange peel and macro-algae are highly variable, but generally have low cellulose and hemicellulose fractions (although may also have very low lignin contents). These biomass feedstocks are no longer purely lignocellulosic in nature.
- Least suitable appear to be many of the agro-industry residues (shells, husks) and forestry bark, due to their very high lignin contents. These however do have good calorific values for energy production, despite their high ash.

Appendix C - Product descriptions

Ethanol

A primary alcohol with 2 carbon atoms. Ethanol is a colourless, volatile, flammable liquid produced by yeast fermentation of carbohydrates, or synthetically, by hydration of ethylene. It is used chiefly as a transport fuel or fuel additive (replacing fossil gasoline), with other applications being used as heating fuel, a solvent, a chemical industry feedstock, and in beverages, antiseptics and medicines.

Bioethanol is currently produced by yeast fermentation of sugar-rich and starch-rich biomass like sugarcane (Brazil), maize (North America) or cereals (Europe). Globally ~86,000 kton/year is produced primarily for applications in biofuels. The industrial production of ethanol from second-generation lignocellulose biomass is rapidly developing, with many projects being developed in the US and EU.

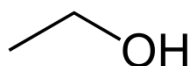

n-Butanol

A primary straight-chain alcohol with 4 carbon atoms, systematically named as butan-1-ol. n-butanol is an important chemical building block, particularly for the manufacture of butyl acetate, and therefore has uses as a solvent in paints and coatings for wood products, but also appearing as a food flavouring. Most industrial initiatives in the field of n-butanol, however, are aimed at the biofuels market (replacing fossil gasoline) in light of the better fuel properties of n-butanol compared to ethanol, as a result of higher energy content, lower water miscibility and less corrosive properties.

The production of n-butanol has historically taken place via acetone, butanol and ethanol (ABE) fermentation. Some strains reduce the acetone produced directly into isopropanol, resulting in the IBE fermentation. This process was industrialised in the last century, however it became more economical to produce these solvents chemically via fossil propylene. Currently, many companies are actively trying to re-introduce the ABE or IBE process commercially again, particularly in China. Much progress has been achieved on improving the economics of the process (strains with better product ratios, higher productivities and greater resistance to the products), however, bottlenecks in the separation on the products remain to be solved completely.

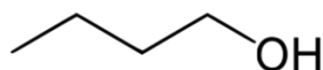

Isobutanol

A branched chain alcohol with 4 carbon atoms, systematically named as 2-methylpropan-1-ol. Isobutanol is a colourless, flammable liquid with a characteristic smell. In the petrochemical sector, it is manufactured by the carbonylation of propylene, and is an important platform chemical with broad applications, particular use as a solvent. Its manufacture via GMO fermentation of sugars will allow the direct replacement of petroleum-derived isobutanol as a drop-in molecule.

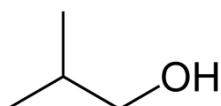

Isobutene

A 4-carbon branched alkene, systematically named as 2-methylpropene (but also known as isobutylene). It is a colourless and volatile gas. Due to its toxic properties isobutene is a highly regulated chemical and stringent measures need to be followed to prevent leakage into the environment.

Isobutene is a key precursor for numerous chemicals. Isobutene is added to methanol to produce MTBE (methyl tert-butyl ether) and with ethanol to produce ETBE (ethyl tert-butyl ether) which are the main types of fuel additives in the market. Isobutene is used in the production of isooctane, which is a fuel additive used in the aviation fuel. It is also extensively used in the manufacturing process of rubber used to produce tyres and tubes for the automotive industry.

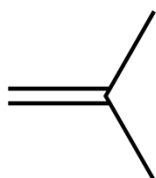

Propane-1,3-diol (PDO)

A diol with 3 carbon atoms. PDO is a colourless viscous liquid that is miscible with water. It is mainly used as a chemical building block in the production of polymers such as polytrimethylene terephthalate (PTT). PDO can also be formulated into a variety of industrial products including composites, adhesives, laminates, coatings, moldings, aliphatic polyesters, copolyesters. It is also a solvent and used as an antifreeze and in wood paint.

PDO has a global market volume of 125 kt/yr. A large part of this production volume is already biobased, since biobased PDO has been an industrial process for quite some time. The current global production capacity of biobased PDO is ~90 kt/yr with an expected increase to over 100 kt/yr in 2016, of which the largest share is produced by DuPont.

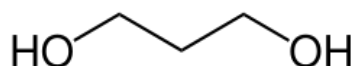

Butane-1,4-diol (BDO)

A diol with 4 carbon atoms. BDO is a colourless, viscous liquid. In the petrochemical industry, it can be produced in various ways from acetylene, propylene oxide, although a large percentage is currently being produced from maleic anhydride via a process that is owned by Davy Process Technologies.

BDO is used industrially as a solvent and in the manufacture of some types of plastics, elastic fibers and polyurethanes. In organic chemistry, 1,4-butanediol is used for the synthesis of γ -butyrolactone (GBL). In the presence of phosphoric acid and high temperature, it dehydrates to the important solvent tetrahydrofuran (THF). Various large companies and consortiums are working on the development and upscaling of biobased BDO; the current production is still at demonstration level. Bio-based BDO will be a direct drop-in replacement for fossil BDO.

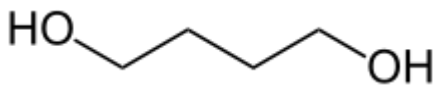

Xylitol

A sugar alcohol, or polyol, containing 5 carbon atoms, systematically named as (2*R*,3*r*,4*S*)-Pentane-1,2,3,4,5-pentol. Xylitol is a clear solid, also known as wood or birch sugar. It is a rare sugar, naturally found in low concentrations in the fibres of many fruits and vegetables, and can be extracted from various berries, oats, and mushrooms, as well as fibrous material such as corn husks and sugar cane bagasse. Industrial production starts from xylan (a hemicellulose) extracted from hardwoods or corncobs, which is hydrolyzed into xylose and catalytically hydrogenated into xylitol.

It has attracted global interest due to its use as a diabetic sweetener – with a similar taste to sucrose, but less calories. Xylitol has applications and potential for use in food (confectioneries and chewing gums), odontological (anticariogenicity, tooth rehardening and remineralization) and pharmaceutical applications.

Xylitol represents a high value product that can be produced in a biorefinery from xylose. Several microorganisms have been developed for this biotechnological conversion. However, technological bottlenecks exist in the areas of the fermentability of the lignocellulosic streams used as feedstock, and in a costly separation of xylitol from the fermentation broth.

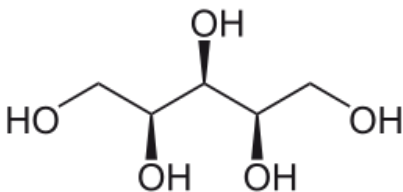

Terephthalic acid

A cyclic dicarboxylic acid with 8 carbon atoms, systematically named as 1,4-benzenedicarboxylic acid. Terephthalic acid is a white solid, used principally as a precursor to the polyester PET for clothing and plastic bottles. In the petrochemical industry, there are several routes to producing terephthalic acid, with oxidation of para-xylene being the most commonly used. The purity of the terephthalic acid is an important criteria for the down-stream synthesis of PET, hence different processes are focused on the minimising of by-products and impurities. Purified Terephthalic Acid is known by the acronym PTA. Bio-based routes to terephthalic acid are all focused on the production of bio-based para-xylene.

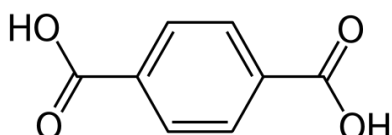

Succinic acid

A dicarboxylic acid with 4 carbon atoms, systematically named as butanedioic acid. It is a white, odourless solid. Succinic acid is produced by several methods – common petrochemical routes include hydrogenation of maleic acid, oxidation of 1,4-butanediol, and carbonylation of ethylene glycol.

Succinic acid is a platform chemical that has a broad range of applications, from high-value niche applications such as personal care products and food additives (used in the food and beverage industry as an acidity regulator), to large volume applications such as plasticizers, polyurethanes, resins and coatings. The possible applications for succinic acid expected to register strong demand growth in the near future are plasticizers, polyurethanes, bio- plastics, and chemical intermediates, with a particular focus on routes to BDO, PBS/PBST and polyester polyols.

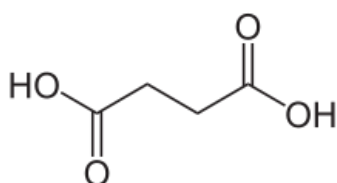

Lactic acid

An organic acid with 3 carbon atoms, systematically named as 2-hydroxypropanoic acid. In industry, lactic acid fermentation is performed by lactic acid bacteria, which convert glucose and sucrose to lactic acid. Lactic acid is a bulk product with applications originally in the food, pharmaceutical and personal care market. Two molecules of lactic acid can be dehydrated to lactide, a cyclic lactone, which can then be polymerized to make polylactic acid (PLA), one of the key drivers for lactic acid market growth.

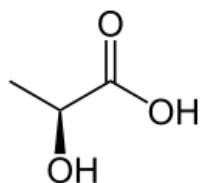

Itaconic acid

A branched dicarboxylic acid with 5 carbon atoms, also known as methylenesuccinic acid, but systematically named as 2-methylidenebutanedioic acid. Itaconic acid is a naturally occurring, non-toxic, and readily biodegradable white crystalline powder. Historically, itaconic acid was obtained by the distillation of citric acid. Since the 1960s, it has been produced industrially by the fermentation of carbohydrates.

Itaconic acid is an important building block in the chemical industry, used mainly in the production of lubricants and as a co-monomer in the production of acrylonitrile-butadiene-styrene and acrylate latexes (with applications in the paper and architectural coating industry). However, it still occupies only a niche market due to the fact that only few end use applications with high volume markets have been identified, but not developed until recently.

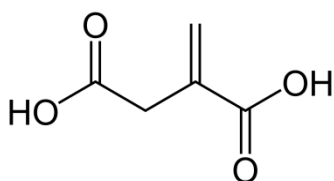

Levulinic acid

An organic acid with 5 carbon atoms, systematically named as 4-oxopentanoic acid. This white crystalline solid is soluble in water and polar organic solvents. Levulinic acid is usually obtained by the hydrolysis of sucrose to glucose, isomerisation to fructose, then dehydration of fructose to hydroxymethylfurfural (HMF), followed by hydrolysis resulting in levulinic acid with formic acid as a by-product.

Presently, levulinic acid finds applications in pharmaceuticals, pesticides, cosmetics, food additives and minor uses in nylons, synthetic rubbers and plastics. It has been identified critical building block to act as a precursor to specialty chemicals including fuel additives such as Methyltetrahydrofuran (MTHF), pesticides such as D-amino levulinic acid (DALA) and Diphenolic Acid (DPA). Potential biofuels can also be prepared from levulinic acid including methyltetrahydrofuran, valerolactone, and ethyl levulinate.

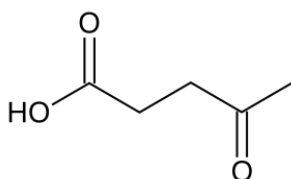

Furfural

A heterocyclic aldehyde with 5 carbon atoms. It is a colourless oily liquid, toxic and a skin irritant. It is derived from a variety of agricultural byproducts, including corncobs, oat, wheat bran, and sawdust. Under heat and acid conditions, xylose and other C5 sugars undergo dehydration, losing three water molecules to become furfural. Furfural and water evaporate together from the reaction mixture, and separate upon condensation. For crop residue feedstocks, between 3% and 10% of the mass of the original plant matter can be recovered as furfural, depending on the type of feedstock.

Furfural is an important chemical solvent and chemical building block. Hydrogenation of furfural provides furfuryl alcohol (FA), which is a useful chemical intermediate and which may be further hydrogenated to tetrahydrofurfuryl alcohol (THFA). It is also used to make other furan chemicals, such as furoic acid (via oxidation), and furan (via decarbonylation).

China is the biggest supplier of furfural, and accounts for the greater part of global capacity. The other two major commercial producers are Illovo Sugar in the Republic of South Africa and Central Romana in the Dominican Republic.

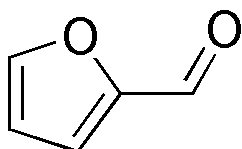

Furan-2,5-dicarboxylic acid (FDCA)

A heterocyclic diol with 6 carbon atoms, also known as dehydromucic acid. It is a white solid, and highly stable. There are numerous routes to its production, including dehydration of hexose derivatives, oxidation of 2,5-disubstituted furans, catalytic conversion of furan derivatives and biological conversion of HMF. FDCA is therefore an oxidized furan derivative.

FDCA is an important renewable building block for polymerisation. It can also substitute for terephthalic acid in the production of polyesters (such as PET), giving rise instead to a new class of Polyethylene Furanoate (PEF) polymers. FDCA could also substitute other materials such as adipic acid, levulinic acid and succinic acid.

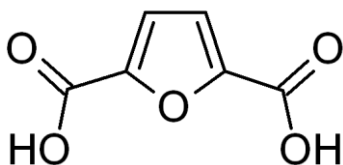

Acrylic acid

An organic acid with 3 carbon atoms, systematically named as prop-2-enoic acid. It is a clear, colourless, corrosive liquid with a characteristic acrid or tart smell. The petrochemical industry produces acrylic acid from the oxidation of propylene (produced from the cracking of naphtha). Asia Pacific is the biggest market for acrylic acid, accounting for 47% of the market in 2013. It is also the fastest growing market for acrylic acid due to a demand from end use industries.

Acrylic acid and its esters readily combine with themselves (to form polyacrylic acid) or other monomers (e.g. acrylamides, acrylonitrile, vinyl, styrene, and butadiene) by reacting at their double bond, forming homopolymers or copolymers which are used in the manufacture of various plastics, coatings, adhesives, fibres and textiles, resins, detergents and cleaners, elastomers (synthetic rubbers), as well as floor polishes, and paints. Acrylic acid is also widely used as a chemical intermediate in multiple industrial processes.

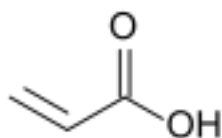

Adipic acid

A dicarboxylic acid with 6 carbon atoms, systematically named hexanedioic acid. This is a white, odourless crystalline solid.

Historically, adipic acid was prepared by oxidation of various fats, and initial petrochemicals routes either involved phenol, cyclohexane or benzene. However, shifts in the hydrocarbons market have eliminated phenol as a feedstock for producing adipic acid, with cyclohexane being primarily used as replacement. Cyclohexane processes now account for over 90% of total adipic acid produced globally. Bio-based alternatives for producing adipic acid are in the development stage.

From an industrial perspective, at 2.5 million tonnes/yr produced, adipic acid is the most important dicarboxylic acid. It is mainly used for the production of nylon 6,6 for composite materials, with growing demand for nylon fibre and nylon resins from industries such as automotive and footwear expected to remain a key factor driving the global market over the next six years. Other applications of adipic acid include paints and coatings, plastic additives, polyurethane resins, low temperature lubricants, food additives and synthetic fibres.

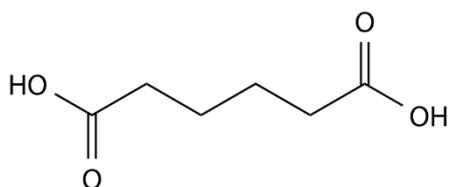

Farnesene

A branched chain alkene with 15 carbon atoms. The term farnesene refers to a set of six closely related chemical compounds which all are sesquiterpenes. (E,E)- α -Farnesene is the most common isomer in nature,

found in the coating of apples, and other fruits, and it is responsible for the characteristic green apple odour.

Trans- β -farnesene (systematic name 7,11-dimethyl-3-methylene-1,6,10-dodecatriene) can be produced by the fermentation of sugars by GM yeast. This is a building block with applications including use in solvents, emollients and polymer additives. It has also been demonstrated as an aviation fuel and in diesel buses (thereby substituting fossil kerosene or diesel). The chemical structure is shown below.

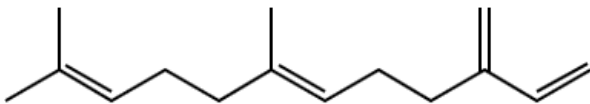

Polyethylene (PE)

PE is the most widely manufactured polymer globally, with a market size of ~85million t/yr. Its primary use is in packaging (plastic bags, plastic films, geomembranes, containers including bottles, tubes, etc.) PE can be made by dehydrating ethanol to ethylene and subsequently polymerising the ethylene. PE is classified into several different categories based mostly on its density and branching. Its mechanical properties depend significantly on variables such as the extent and type of branching, the crystal structure and the molecular weight.

Biobased PE has been in the market for several years, and with several plans for new production facilities, biobased production is expected to increase to ~750 kt/year by around 2015, making bioPE by far the largest fully bio-based plastic in terms of volume.

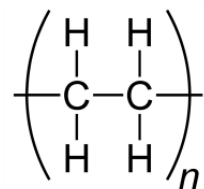

Poly(lactic acid) (PLA)

Poly(lactic acid), or polylactide, is a thermoplastic polyester. It is a fully bio-based plastic, derived from corn starch (in the US), tapioca roots, chips or starch (in Asia) or sugarcane (in the rest of the world). PLA is biodegradable/compostable under certain circumstances.

PLA was originally developed for medical applications (Netherlands in the 70s). Commercialization of a lower priced grade was carried out in the 90s by Nature Works. Production occurs via fermentation of sugars to lactic acid, then dehydration to form lactide, which can then be polymerized to make PLA.

PLA is suitable for packaging materials, insulation foam, car parts, fibres (textile and non-woven). The PLA market is now expanding, and although the down-stream processing has improved significantly over recent years (lowering the price), it is still slightly more expensive than fossil alternatives that serve similar markets.

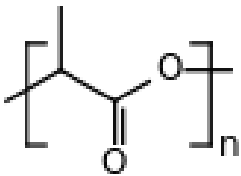

Poly(butylene succinate) (PBS)

PBS is a relatively new thermoplastic polyester. The material is biodegradable and used for blending with starch polymers to improve properties. PBS is most commonly manufactured via the esterification of succinic acid and butane-1,4-diol. PBS has previously been of fossil origin, but developments to produce it from bio-based succinic acid and bio-based BDO are on their way.

PBS has a properties profile similar to that of polypropylene (PP), the second largest polymer (~55million t/yr world-wide), thus the potential application area is enormous. However, PP is very low priced, so this market will be out of reach for the coming years.

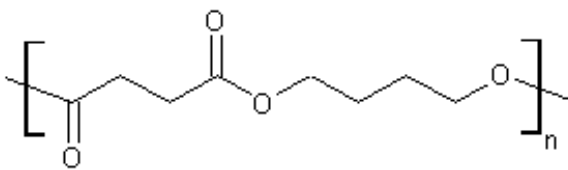

Polyethylene terephthalate (PET)

PET comprises approximately 8% of the total polymer market at ~20million t/yr world-wide, but is the largest polyester in the market (hence the common name 'polyester'). It is a very versatile material, highly suitable for packaging (bottles and containers), fibres (fleeces and other clothing) and other engineering composite resins. PET can be easily recycled, with the potential to apply solid state post-condensation to match properties of the recycled PET with those of virgin material.

The PET monomer, ethylene terephthalate, is typically manufactured either via the esterification of ethylene glycol and terephthalic acid, or via the esterification of ethylene glycol and dimethyl terephthalate. Partly bio-based PET is already in the market, with Coca Cola's Plant Bottle, in which the ethylene glycol is biobased. New routes to producing bio-based terephthalic acid (via para-xylene) are also being explored, in order to make 100% bio-based PET.

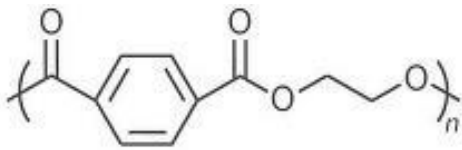

Polyethylene furanoate (PEF)

PEF, also named polyethylene furandicarboxylate, is similar to PET, but with the terephthalic acid replaced by 2,5 furandicarboxylic acid (FDCA) in the esterification step. The properties of PEF are similar to those of PET, but the material has superior barrier properties (both for O₂ and CO₂) which makes it an attractive candidate for soft-drink bottles. PEF also has higher tensile strength and better high temperature properties. However, the fact that PEF is not a drop-in polymer to replace PET implies that a new market needs to be developed, which may take time.

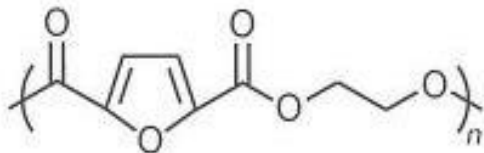

Polyethyl methacrylate (PEMA)

PEMA or 'Perspex' is mainly used in the construction sector, as it is a very strong and transparent material, offering a lightweight and shatterproof alternative to glass. Biobased PEMA can be produced by decarboxylation of itaconic acid to methacrylic acid, and then subsequent esterification to methyl methacrylic acid, before polymerisation. Commercial production of biobased PEMA is expected for 2016-2018.

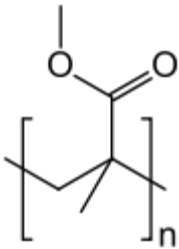

Polyhydroxyalkanoates (PHAs) and PHB/PHBV

Polyhydroxyalkanoates or PHAs are a class of linear polyesters produced in nature by the direct bacterial fermentation of sugar or lipids. They are produced by the bacteria to store carbon and energy, usually under conditions of physiological stress. These plastics are biodegradable (suitable for home composting) and can either be thermoplastic or elastomeric materials. More than 150 different monomers can be combined within this family to give materials with extremely different properties. PHAs are increasingly used for blending, for instance to increase the impact resistance of PLA.

PHAs were originally developed in the 1990s. PHBV has been commercial from early 1990s but due to its high price it has not been able to gain a large market share. The properties of the material can be tuned by changing the chemical composition. Polyhydroxybutyrate (PHB) and polyhydroxyvalerate (PHBV) are common types of PHAs seen in nature. PHB is similar in its material properties to polypropylene (PP), has a good resistance to moisture and aroma barrier properties. The chemical structure is shown below.

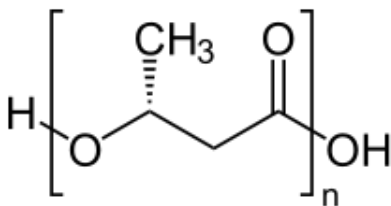

Polyisoprene

Polyisoprene is a synthetic rubber, mainly used for car tyres, but also for hoses, belts, medical gloves, golf balls and glues. Natural rubber is the polymerisation product of cis-1,4-isoprene, and has very high stereochemical purity and molecular weight, which cannot be matched by the synthetic polymerisation of isoprene. Natural rubber has therefore maintained a high market share of around one third of the total 15 million t/yr rubber market.

Polyisoprene from isoprene based on sugars is being developed by various companies to replace fossil-derived rubber products (such as styrene-butadiene rubbers). Fossil based isoprene is most readily available industrially as a by-product of the thermal cracking of naphtha or oil, as a side product in the production of ethylene.

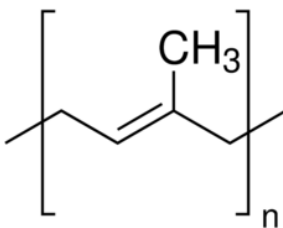

Algal oils

The means of algal oil production referred to here is the heterotrophic fermentation of sugar feedstocks to oils by algae. The process takes place in the absence of light. Early commercial dark fermentation processes use sugarcane or other sugary feedstocks as substrates, but organic wastes can be used in theory as well. The phototrophic production of oil by microalgae is not considered here as this route is not as close to commercialisation and also does not go via the sugar platform.

There are many potential uses for the algal oils produced, including conversion into biodiesel for fuel, in cosmetics, for food, for personal care and industrial products.

Different strains of algae may be used to produce different types of oil; e.g. triglycerides (an example shown below) or a mix of hydrocarbons similar to light crude petroleum.

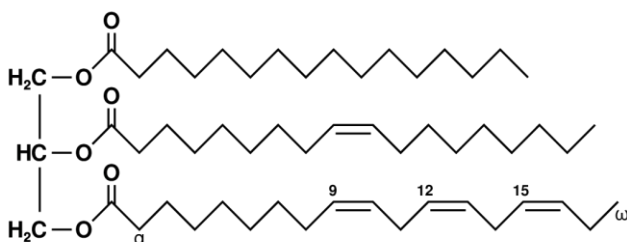

Appendix D - Potential impacts of lower crude oil prices

The market analysis carried out in the study (as discussed in Section 4 of the main report) collected product prices and market volumes using references mainly from 2013 and 2014. The dramatic drop in the price of crude oil globally (of ~50%) within the last 6 months means that if these lower prices are now sustained, the price of many of the fossil chemicals and materials listed in the study could end up significantly cheaper than those quoted in the report.

This Appendix does not set out to estimate the latest fossil chemical prices based on a much lower crude price, rather to qualitatively discuss which fossil products (and hence the competitiveness of sugar platform equivalents) are most likely to be influenced by a sustained fall in global crude oil prices. In many cases, the fossil feedstock cost (crude oil or natural gas) is a significant proportion of the total production cost for a particular chemical or fuel (Ray et al, 2014). Some of the major production pathways are shown below in Figure 37.

Some biochemicals and biopolymers, such as **isobutene** and **adipic acid**, are drop-in replacements for predominately crude oil derived chemicals and polymers, and hence the economic competitiveness of these bioproducts is therefore likely to have been significantly (negatively) impacted by the reduced production costs of their fossil competitor.

However, other chemicals and polymers are typically derived from natural gas, which has not seen the same dramatic drop in prices in the last 6 months (there have been more modest falls in the US, and little change in the EU). The economic competitiveness of bio-based based drop-in replacements for predominately natural-gas derived products such as **polyethylene** is therefore unlikely to have significantly shifted. Other products are usually produced from a variety of natural gas and crude oil pathways, and hence the economic impact of falling crude prices is likely to be modest, or regionally dependent – for example, **succinic acid**, **BDO** and **acrylic acid**.

It is worth noting that there are typically a number of different methods of producing each product, some of which may be crude oil based and others natural gas based. The relative economics of oil vs. gas, and the compositions of some of the remaining marginal oil and gas reserves (such as tar sands, tight oils and shale gas) will determine the proportion of C2-C4 molecules that are produced via naphtha cracking or natural gas processing – for example, whether the butane for succinic acid production, or the propylene for acrylic acid, originates from natural gas or crude oil. The picture is therefore not straightforward – the above indications of price impacts are based on the predominant fossil production routes in operation currently.

The shale gas boom in the US produced large volumes of ethane, meaning that naphtha cracking activity was reduced, which led to reduced availability of C3-C5 fractions (IHS, 2014). However, with crude oil prices falling sharply relative to natural gas in many regions, this means that naphtha cracking to produce light ends (C2-5s) may start becoming more economically competitive again, and hence increase the availability of C3-C5 molecules. This is the opposite situation to that described by Jogdand (2014).

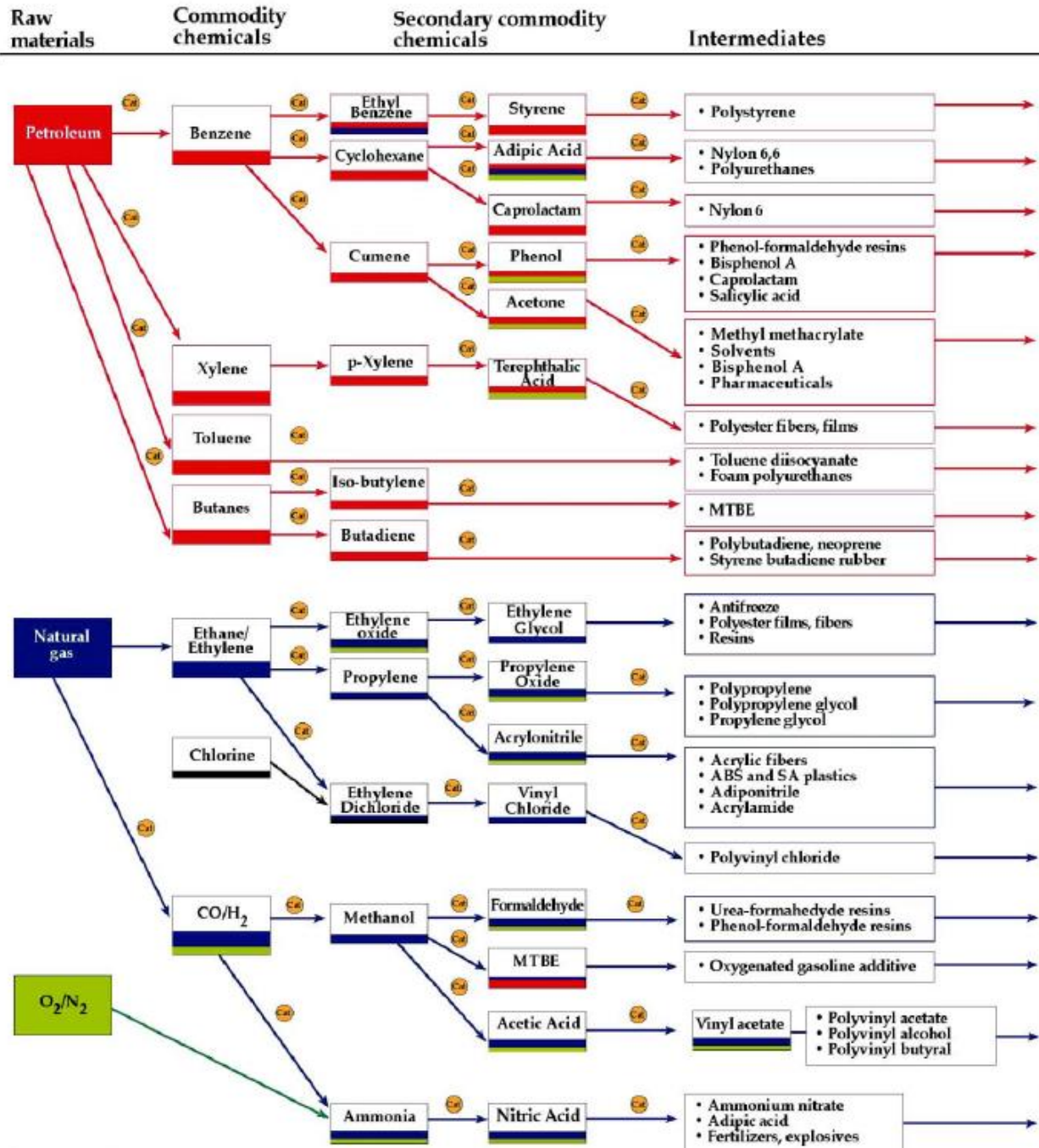

Figure 37: Example flow-chart for products from fossil-based feedstocks (Source: Werpy & Peterson, 2004)

Of course, some biochemicals and biopolymers are not drop-in replacements for fossil-derived products, and either trade in markets without fossil competitors, or have certain unique properties that may help support their competitiveness versus fossil counterfactuals. **FDCA** is mainly competing against fossil terephthalic acid in PET and PBT production, but the resulting PEF and PBF have significantly improved properties that should help to offset the dramatic drop in terephthalic acid prices. The bio-degradability and tuneability of **PHAs** and **PLA** will to some extent help insulate them from price decreases in comparable fossil polymers (e.g. PS and PET) – and less price movement is expected in PE and PP comparators (as these are mainly natural gas based). The largest markets for **farnesene** (fossil diesel, jet, oils and tyres) will have fallen in price, although farnesene does offer some advantages – and its niche markets (e.g. cosmetics, fragrances) have few competitors with the same characteristics.

We also note that biomass feedstock costs typically comprise a large part of the total production cost for a particular biochemical, biofuel or biopolymer. Lower crude oil prices will generally lead to lower diesel costs (dependent on taxation), and hence cheaper biomass harvesting and transportation, which will help reduce production costs for sugar platform products. However, this benefit is likely to be smaller than the impact on the fossil counterfactual price, as biomass production is more labour intensive than fossil production, and with several other costly inputs besides diesel (e.g. fertiliser, seeds).

Appendix E - Safety issues regarding the use of micro-organisms in biofuels processing

Introduction

The majority of processing pathways from sugars to biofuels and biochemicals involve the use of micro-organisms which are able to convert sugars into the desired product or intermediate. The micro-organisms are either natural (wild type) or genetically modified (GM). In general, this is a one step process mostly performed in stirred tanks called fermenters. The scale of production is dependent on the product but can be in the range of 1,000-1,000,000 Litres. After the production process, in which the micro-organisms are cultivated, the final product will be separated from the culture broth leaving a microbe containing waste stream. In the case of a non-GMO process, this waste stream is often upgraded and marketed as protein and fibre rich feed.

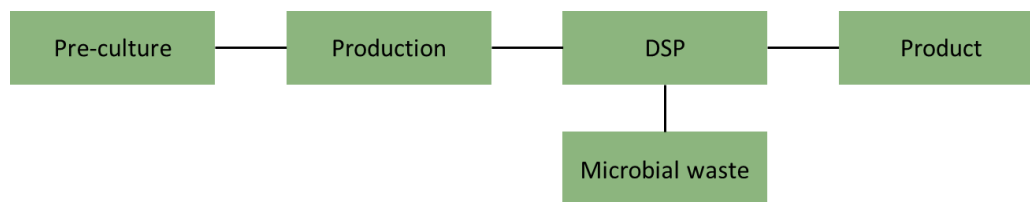

Figure 38: Process for the use of micro-organisms in biofuels processing

In this chapter, EC regulations on the use of microorganisms and safety and environmental issues concerning the use of microorganisms in the biofuels and biochemicals production process are assessed.

EC directives on the use of micro-organisms

There are three main directives that impact the use of microorganisms in the Sugar Platform:

- EC regulations on the use of microorganisms have been laid down in Directive 2000/54/EC – on the protection of workers from exposure to biological agents.
- EC regulation on working with genetically modified organisms (GMOs) has been laid down in two directives;
 - Directive 2009/41/EC - on the contained use of genetically modified micro-organisms (GMMs)
 - Directive 2001/18/EC - on the deliberate release into the environment of genetically modified organisms.

If the microbial waste is to be used for feed purposes, Regulation (EC) No 1829/2003 on genetically modified food and feed may also be applicable, but this issue is beyond the scope of this report.

An overview on “The EU Legislation on GMOs” is given in EUR 24279 EN - 2010 a report from the European Commission Joint Research Centre (JRC)⁴⁵⁴.

⁴⁵⁴http://publications.jrc.ec.europa.eu/repository/bitstream/111111111/14655/1/reqno_jrc57223_2010-08-12_eu_gmo_legislation_report_final.pdf%5b1%5d.pdf

Directive 2000/54/EC applies to the processes described in this report in which wild type micro-organisms are used and Directive 2009/41/EC applies when genetically modified are used since the process plant can be considered a contained growth system.

Some aspects of Directive 2001/18/EC may be taken into consideration when emergency plans are being set up or when (local) authorities ask for an additional risk assessment.

These EC directives are the backbone of the safety regulations in the EU Member States. In 2011, a “Survey on the implementation of Directive 2009/41/EC” was commissioned by the Netherlands Commission on Genetic Modification (COGEM). One of the main conclusions is that although there are some significant differences in the procedural, administrative and technical implementation of Directive 2009/41/EC in the 11 Member States, in general, the representatives of CAs (Competent Authorities), advisory bodies, inspectorates and applicants interviewed are of the opinion that the procedures and technical requirements for contained use of GMMs and GMOs in their Member States do not pose insurmountable challenges. The full report is available at the COGEM website⁴⁵⁵.

A 1992 OECD report on “Safety Considerations for Biotechnology” set out general principles and criteria for safe large-scale industrial production and small-scale experimental field research in biotechnology⁴⁵⁶. The report elaborates on the principle of Good Industrial Large Scale Practice (GILSP) for fermentation derived biotechnology products and defines Good Developmental Principles (GDP) for the design of safe small scale field research with plants and micro-organisms with newly introduced traits. It acts as the foundation for all regulations relating to the industrial use of GM micro-organisms (GMMs).

Current and historic use of micro-organisms

Traditionally, only a few species of micro-organisms have been used in (large scale) biofuels and biochemicals processing. These are:

- *Saccharomyces cerevisiae* also known as baker’s yeast
- *Escherichia coli* K12, a Gram-negative, facultative anaerobic, rod-shaped bacterium
- *Wildtype Clostridium acetobutylicum*, a Gram-positive obligate anaerobic bacteria was used during World War I for the production of acetone, butanol and ethanol⁴⁵⁷.
- Lactic acid bacteria, which comprise a clade of Gram-positive, acid-tolerant, generally non-sporulating, non-respiring rod or cocci shaped bacteria, are the traditional producers of lactic acid⁴⁵⁸
- *Aspergillus oryzae* and *Aspergillus niger*, fungi belonging to the Ascomycota phylum, respectively used for fermentation and the production of citric acid⁴⁵⁹.

From recent scientific developments a number of new industrial production processes emerged in which new, often genetically modified, microorganisms are being used.

⁴⁵⁵ <http://www.cogem.net/index.cfm/en/publications/publicatie/survey-on-the-implementation-of-directive-2009-41-ec>

⁴⁵⁶ <http://www.oecd.org/science/biotech/2375496.pdf>

⁴⁵⁷ Jones, DT; Woods, DR (1986). Acetone-butanol fermentation revisited. Microbiological reviews 50 (4): 484–524

⁴⁵⁸ Kenji Okano & Tsutomu Tanaka & Chiaki Ogino & Hideki Fukuda & Akihiko Kondo (2010) Biotechnological production of enantiomeric pure lactic acid from renewable resources: recent achievements, perspectives, and limits. Appl Microbiol Biotechnol 85:413–423

⁴⁵⁹ E. Schuster, N. Dunn-Coleman, J. C. Frisvad, and P. W. M. van Dijck (2002) On the safety of *Aspergillus niger* – a review. Appl Microbiol Biotechnol (2002) 59:426–435

Safety of micro-organisms used in biofuels and biochemicals processing

The characteristics of the micro-organisms used in biofuels and biochemical processing determine, to a great extent, the level of protection necessary for safe use, as described in directives 2000/54/EC and 2009/41/EC.

A risk assessment is the starting point for applying GMM safety regulations (the national implementation of the EC Directives in this case). The first and most important aspect for a risk assessment relevant to the processes described in this report is whether the organism is considered to be a pathogen (causing a disease).

For pathogenicity the EC has categorized four risk groups;

- Group 1: An agent that is unlikely to cause human disease
- Group 2: An agent that can cause human disease and might be a hazard to workers; it is unlikely to spread to the community; there is usually effective prophylaxis or treatment available
- Group 3: An agent that can cause severe human disease and present a serious hazard to workers; it may present a risk of spreading to the community, but there is usually effective prophylaxis or treatment available
- Group 4: An agent that causes severe human disease and is a serious hazard to workers; it may present a high risk of spreading to the community; there is usually no effective prophylaxis or treatment available

Several sources provide information on the risk group of certain microorganisms e.g. Annex III to Directive 2000/54/EC, the American Biological Safety Association (ABSA), NIH Guidelines appendix B, or the Deutsche Sammlung von Mikroorganismen und Zellkulturen (DSMZ). Table 18 shows the risk group of the organisms used in biofuels and biochemical production. *Aspergillus niger* is especially known for its citrate production but is now also being modified for other organic acid production processes. It is sometimes assigned to risk group 2, however after lengthy studies, specific industrial strains are considered safe (risk group 1) according to the US EPA^{460,461}. We note Annex III to Directive 2000/54/EC classifies *Aspergillus niger* as risk group 1.

All microorganisms mentioned in Table 18 belong to pathogenicity risk group 1 which means that they are regarded non-pathogenic (safe). For non GMM strains Annex VI to DIRECTIVE 2000/54/EC states that:

“Containment for industrial processes for work with group 1 biological agents including life attenuated vaccines, the principles of good occupational safety and hygiene should be observed”.

Therefore, basic investment with respect to containment will suffice in this case.

⁴⁶⁰ http://www.epa.gov/biotech_rule/pubs/fra/fra006.htm

⁴⁶¹ E. Schuster, N. Dunn-Coleman, J. C. Frisvad, and P. W. M. van Dijck (2002) On the safety of *Aspergillus niger* – a review. Appl Microbiol Biotechnol (2002) 59:426–435

Table 18: An overview of products from bioprocesses and the microorganisms used

Product [#]	Organism	Risk group	GMM	Companies*
Ethanol	<i>Saccharomyces cerevisiae</i>	1	No	
Ethanol	<i>Kluyveromyces marxianus</i>	1	No	
Ethanol	<i>Zymomonas mobilis</i>	1	Yes	DuPont
Acetone and butanol	<i>Clostridium acetobutylicum</i>	1	No	Butamax, GreenBiologics
Butanol	<i>Clostridium acetobutylicum</i>	1	No	GreenBiologics
Citric acid	<i>Aspergillus niger</i>	1		
Farnesene	<i>Saccharomyces cerevisiae</i>	1	Yes	Amyris
PHA	<i>Alcaligenes eutrophus</i>	1		MHG Meridan
PHA	<i>Escherichia coli</i>	1	Yes	Metabolix
Lactic acid	<i>Lactobacillus sp.</i>	1	No	Purac, Galactic, NatureWorks LLC
Lactic acid	<i>Saccharomyces cerevisiae</i>	1	Yes	VTT
	<i>Pichia kudriavzevii</i>	1	Yes	VTT
	<i>Issatchenkia orientalis</i>	1	Yes	NatureWorks LLC
Succinic acid	<i>Escherichia coli</i>	1	Yes	
	<i>Corynebacterium glutamicum</i>	1	Yes	
	<i>Aspergillus niger</i>	1	Yes	DSM
	<i>Saccharomyces cerevisiae</i>	1	Yes	DSM
Acrylic acid	<i>Escherichia coli</i>	1	Yes	Metabolix
1,4 Butanediol	<i>Escherichia coli</i>	1	Yes	Genomatica
Itaconic acid	<i>Aspergillus niger</i>	1	Yes	
Isobutanol	<i>Escherichia coli</i>	1	Yes	Gevo
Isobutanol	<i>Saccharomyces cerevisiae</i>	1	Yes	Butamax
Fatty acids	<i>Protetheca moriformis</i>	1	Yes	Solazyme
	<i>Prototheca krugani</i>	1	Yes	Solazyme
	<i>Chlorella protothecoides</i>	1	Yes	Solazyme

some processes are still in the experimental or start-up phase

* only mentioned in case of a clear leading company or companies

As mentioned previously, Directive 2009/41/EC applies when GMMs are used in biofuels or biochemicals processing. Directive 2009/41/EC defines four levels of containment. Level 1 in case of no or negligible risk, level 2 at low risk, level 3 at moderate risk, and level 4 at high risk.

Since level 1 containment has the lowest impact in terms of containment and other protective measures and thus on investment costs, it is important to take a view on whether the microorganisms listed in Table 18 meet the requirements of containment level 1. It should be noted that for GMMs, not only the characteristics of the organism itself (the host) determines the level of safety, but also the characteristics of the modified genetic material.

According to Directive 2009/41/EC Annex III, only GMMs which show the following characteristics would be considered appropriate for level 1 containment:

- the recipient or parental micro-organism (host) is unlikely to cause disease to humans, animals or plants

- the nature of the vector and the insert (the new genetic material introduced) is such that they do not endow the GMM with a phenotype likely to cause disease to humans, animals or plants, or likely to have deleterious effects on the environment
- the GMM is unlikely to cause disease to humans, animals or plants and is unlikely to have deleterious effects on the environment

All organisms mentioned in Table 18 belong to risk group 1 (non-pathogenic), some of which also have a long history of safe use. As far as the available information shows they are genetically modified with genes which do not encode toxins or other pathogen related proteins. The organisms are common in the environment with no known deleterious effect, and would therefore fall into level 1 containment. The impact of this low risk classification is discussed below.

For other micro-organisms to be applied in biotechnological processes a similar risk assessment can be made according to Directive 2009/41/EC (or its implementation at a member state level).

Implications of the use of (GM)-micro-organisms in industrial processes

As described in the previous paragraph the risk assessment of the micro-organism according to the EC Directives leads to a required level of containment for the use in a bioprocess. This containment level is linked to minimum requirements and measures necessary for safe use for workers and the environment.

As stated before the outcome for non-GMO is risk group 1 for which the principles of good occupational safety and hygiene should be observed.

For the GMMs assessed, the outcome is level 1 for which the minimum containment and other protective measures are defined in Annex IV of Directive 2009/41/EC.

In addition to the principles of good microbiological practice and the principles of good occupational safety and hygiene defined in the aforementioned Annex IV (which apply for all activities involving GMMs), additional measures are defined for specific activities. The table below gives an example of such specific activities for equipment and waste treatment for level 1 and level 2 containment. Again one has to bear in mind that national (or sometimes even local) authorities can impose additional measures.

Table 19: Additional safety measures for level 1 and level 2 containment

Equipment	Level 1	Level 2
Surfaces resistant to water, acids, alkalis, solvents, disinfectants and decontamination agents, and easy to clean	Required(bench)	Required(bench)
Entry to lab via airlock	Not required	Not required
Negative pressure relative to the pressure of the immediate environment	Not required	Not required
Extract and input air from the laboratory should be HEPA – filtered	Not required	Not required
Microbiological safety post	Not required	Optional
Autoclave	On site	In the building
Waste		
Inactivation of GMMs in effluent from hand washing sinks or drains and showers and similar effluents	Not required	Not required
Inactivation of GMMs in contaminated material and waste	Optional	Required

According to Directive 2009/41/EC (for contained micro-organisms), an Environmental Risk Assessment (ERA) is not obligatory, while in Directive 2001/18/EC – “on the deliberate release into the environment of genetically modified organisms” an ERA is required.

In practice some national or local authorities do request additional information on risks for the environment in case of accidental release of the GMMs, especially in those cases where level 2 containment is applied. An ERA is then the proper way to define these risks. According to Directive 2001/18/EC the objective of an ERA is, “*on a case by case basis, to identify and evaluate potential adverse effects of the GMO, both direct and indirect, immediate or delayed, on human health and the environment which the deliberate release or the placing on the market of GMOs may have*”.

The ERA should be conducted with a view to identifying if there is a need for additional risk management and if so, the most appropriate methods to be used. In Annex II to Directive 2001/18/EC the elements to be considered and the general principles and methodology to be followed to perform the environmental risk assessment are described. Guidance notes supplementing this Annex II outline the objectives and principles as well as the methodology for the ERA in detail.

Important elements which need to be provided in an ERA and which are not part of the risk assessment on contained use are:

- The survival of the GMMs in the environment and the effect on the eco system
- The risk of horizontal gene transfer, especially when antibiotic resistance marker genes are present in the GMMs

Summary

- The micro-organisms used in the biofuel and biochemicals processes mentioned in this chapter belong to the pathogenicity risk group 1, which means that they are considered safe
- For processes using non-GMMs, the principles of good occupational safety and hygiene should be observed
- For GMMs, the combination of the microorganism and the genes used for genetic modification mentioned in this report leads to the application of GMO level 1 containment
- Level 1 containment is the minimal level required and will not impose major investments compared with non-GMM processes
- National or local authorities may ask for an environmental risk assessment which, given the containment used and the use of safe microorganisms, should not impose many difficulties or large investment
- If containment cannot be applied (open systems), Directives on introduction in the environment apply and the obligatory environmental risk assessment becomes an important and often time consuming issue.

Appendix F - Development of criteria for assessing socio-economic impacts

In understanding the criteria that could be used to assess the socio-economic impact of developing a sugar platform on local communities in different parts of the supply chain, we reference the Indicators and Criteria developed by the Roundtable on Sustainable Biomaterials.

Of particular relevance here is Principle 5, which states that: *“In regions of poverty, operations shall contribute to the social and economic development of local, rural and indigenous people and communities”*

Although Principle 5 relates specifically to regions of poverty, the indicators that demonstrate adherence with this principle serve just as well for assessing whether the socio-economic impacts in any community are positive or negative.

Having reviewed the RSB Principle 5 Criteria and indicators, and the RSB Rural and Social Development Guidelines⁴⁶², we have summarised below criteria that could be used to assess whether the socio-economic impacts associated with the development of a sugar platform project have been largely positive or negative. Furthermore, this summary can be used as a checklist for developing a project that implements best practice in relation to socioeconomic issues (although not all of these will be applicable outside regions of poverty):

- Does the core business model generate value for the participating operator and the local communities on an ongoing basis (e.g. outgrower schemes⁴⁶³, joint ventures)?
- In regions of poverty, does the project make voluntary contributions to social services and infrastructure? E.g. wells, schools, health clinics, rural electrification, mills or other labour saving devices
- Have smallholder farmers been involved in feedstock production, either through contract farming or simply committing to purchase a certain percentage of feedstock annually from local farmers at a fair price?
- Can it be demonstrated that household incomes are raised through employment creation, while finding way to safeguard the economic, nutritional and subsistence values of existing livelihoods, e.g. land set asides, flexible working hours during the labour demanding periods of the agricultural cycle?
- With respect to employment,
 - Are local workers preferred over migrant workers?
 - Are permanent jobs created and continue to be created?
 - Is skill training taking place to support the employment of permanent and local workers?
 - If mechanization is optimal from an environmental, economic and social perspective, is the transition from labour intensity to mechanisation done in a fair and equitable way, involving retraining of workforce?

⁴⁶² See <http://rsb.org/sustainability/rsb-tools-guidelines/>

⁴⁶³ An out-grower scheme is a partnership and agreement between a grower/land owner and a company who will buy the product, typically at a price agreed in advance

- Does the project partner with government service providers, NGOs or other international initiatives in supporting income generating activities, particularly those targeting women and other vulnerable groups?
- If in developing countries or regions of poverty, does the social plan for the project include special measures to benefit women, youth, minorities and vulnerable people? For example:
 - Development of value added industries that are operated and managed by women and youth?
 - Specification of jobs that are suitable for vulnerable people or those unable to do hard manual labour?
 - Ensuring that women, youth and the vulnerable are given ample opportunity to apply for work, through careful attention to the ways jobs are advertised and interviews are conducted?
- Is it ensured that some of the economic benefits are channelled to those households most negatively affected by operations (e.g. those losing access to crop and grazing land or economically important forest products)?
- Are there activities to enable directly affected households and vulnerable groups to provide goods and services to the facility (e.g. food for workers, cleaning and cooking services, etc.)?

The measures implemented to ensure socioeconomic benefits should be agreed in advance with the communities, so that they can confirm that the measures will provide the communities with socio-economic benefits.

Appendix G - Glossary of acronyms

Ordered alphabetically, Table 20 below provides the common name of the abbreviations and acronyms found throughout the main report document and Appendices.

Table 20: List of general acronyms and abbreviations

Acronym	Description
1G	1st generation
2G	2nd generation
ABSA	American Biological Safety Association
AFEX	Ammonia fibre explosion/expansion
BCAP	Biomass Crop Assistance Program
BBI	Bio-Based Industries Joint Undertaking
BESTF	BioEnergy Sustaining the Future
BIC	Bio-based Industries Consortium
BNDES	Brazilian Development Bank
BTL	Biomass to liquids
Btu	British thermal unit
CA	Competent authority
CAGR	Compound annual growth rate
CBP	Consolidated bioprocessing
CCS	Carbon capture and storage
CEN	European Committee for Standardization
CHEQ	Carbohydrate equivalents
CIP	Competitiveness and Innovation framework Programme
COGEM	Netherlands Commission on Genetic Modification
CTC	Centro de Tecnologia Canavieira
DSMZ	Deutsche Sammlung von Mikroorganismen und Zellkulturen
DSP	Downstream processing
EBTP	European Biofuels Technology Platform
EC	European Commission
ECN	Energy research Centre of the Netherlands
EFSA	European Food Safety Authority
EIB	European Investment Bank
EIBI	European Industrial Bioenergy Initiative
EPA	US Environmental Protection Agency
ERA	Environmental risk assessment
ERA-NET	European Research Area Network
ETS	Emissions Trading Scheme
EU	European Union
FDA	Food and Drug Administration
FINEP	Financiadora de Estudos e Projetos

FP7	Seventh Framework Programme (EC)
FQD	Fuel Quality Directive
GDP	Gross Domestic Product
GHG	Greenhouse gas emissions
GJ	Gigajoule
GM	Genetically modified
GMM	Genetically modified micro-organism
GMO	Genetically modified organisms
HR	Human resources
IB	Investment barrier
IEA	International Energy Agency
ILUC	Indirect Land Use Change
IP	Intellectual Property
IPO	Initial public offering
JV	Joint venture
kg	Kilogram
kt/yr	Kilotonne per year
ktpa	Kilotonne per annum
L	Litre
LC	Lignocellulosic
LCA	Life-Cycle Assessment
LMI	Lead Market Initiative
MJ	Megajoule
MSW	Municipal Solid Waste
Mtpa	Million tonnes per annum
NA	Not available
NER	New Entrants Reserve
NGO	Non-governmental organization
NIMBY	Not in my back yard
NREL	National Renewable Energy Laboratory
PAISS	Joint Plan for Supporting Industrial Technological Innovation in the Sugar-based Energy and Chemical Sectors
'Platforms'	Intermediate products from biomass feedstocks towards products or linkages between different biorefinery concepts or final products
PPP	Public Private Partnership
R&D	Research and Development
RD&D	Research, Development and Demonstration
RE-CORD	Consorzio per la Ricerca e la Dimostrazione sulle Energie Rinnovabili
RED	Renewable Energy Directive
RFS	Renewable Fuels Standard
RSB	Roundtable on Sustainable Biomaterials
SET Plan	Strategic Energy Technology Plan
SME	Small to medium enterprise
SRC	Short rotation coppice

SRF	Short rotation forestry
SSF	Simultaneous saccharification and fermentation
'Sugar platform'	The collection of platforms that involve any combination of C5, C6 and/or C12 sugars, that exist as intermediates within pathways from biomass feedstock towards final biofuel or biochemical products
SUSCHEM	European Technology Platform for Sustainable Chemistry
t	Tonne
tpa	Tonnes per annum
TRL	Technology Readiness Level
UK	United Kingdom
US/USA	United States (of America)
USDA	United States Department of Agriculture
US DOE	United States Department of Energy
WTO	World Trade Organisation
WUR	Wageningen University and Research Centre

Ordered alphabetically, Table 21 below gives the common names (not IUPAC names) of the chemicals associated with each acronym. Table 22 gives a similar list for the polymer acronyms.

Table 21: List of chemical acronyms

Acronym	Product
2-KGA	2-Ketogluconic acid
3-HP/3-HPA	3-hydroxypropionic acid
5-HMF	5-Hydroxymethylfurfural
ABE	Acetone, n-Butanol, Ethanol
ADA	Adipic acid
BD	Buta-1,3-diene
BDO	Butane-1,4-diol
BMF	5-bromomethylfurfural
BSA	Bio-based succinic acid
BTX	Benzene, Toluene, Xylene
CMF	5-chloromethylfurfural
CO	Carbon monoxide
CO ₂	Carbon dioxide
dALA	d-Aminolevulinic acid
DEG	Diethylene glycol
DFF	2,5-diformylfuran
DHA	Docosahexaenoic Acid
DME	Dimethyl ether
DMF	2,5-Dimethylfuran
DPA	Diphenolic acid
ECH	Epichlorohydrin

EDC	1,2-Dichloroethane
EG	Ethylene glycol
EL	Ethyl levulinate
EMF	5-ethoxymethylfurfural
ETBE	Ethyl tert-butyl ether
FA	Furfuryl alcohol
FAEE	Fatty acid ethyl esters
FAME	Fatty acid methyl esters
FDCA	2,5-Furandicarboxylic acid
GBL	γ -butyrolactone
GVL	gamma-Valerolactone
HDO	Hexane-1,6-diol
HMDA	Hexamethyldiamine
IBE	Isopropanol, butanol, ethanol
IPP	Isopentyl pyrophosphate
LFR	Farnesene Liquid Rubber
KA oil	Ketone-alcohol oil
MAN	Maleic anhydride
MEG	Monomer ethylene glycol
ML	Methyl levulinate
MMA	Methyl methacrylate
MMF	Methoxymethylfurfural
MTBE	Methyl tert-butyl ether
MTHF	Methyltetrahydrofuran
N ₂ O	Nitrous oxide
NaOH	Sodium hydroxide
p-xylene	Para-xylene
PDO	Propane-1,3-diol
PIA	Purified isophthalic acid
PTA	Pure terephthalic acid
THF	Tetrahydrofuran
THFA	Tetrahydrofurfuryl alcohol
TPA	Terephthalic acid

Table 22: List of polymer acronyms

Acronym	Polymer
ABS	Acrylonitrile butadiene styrene
EPDM	Ethylene propylene diene monomer (M-class) rubber
EPS	Expanded polystyrene
HDPE	High-density polyethylene
LDPE	Low-density polyethylene
LLDPE	Linear low-density polyethylene
PA	Poly(acetylene)
PA 4,6	Polyamine Nylon 4-6
PA 6,6	Polyamine Nylon 6-6
PAA	Poly(acrylic acid)
PBD	Poly(butadiene)
PBF	Poly(butylene furandicarboxylate)
PBS	Poly(butylene succinate)
PBT	Poly(butylene terephthalate)
PC	Polycarbonates
PE	Poly(ethylene)
PEF	Poly(ethylene furanoate)
PEG	Poly(ethylene glycol)
PET	Poly(ethylene terephthalate)
PGA	Poly(glycolic acid)
PHAs	Polyhydroxyalkanoates
PHB	Polyhydroxybutyrate
PHBV	Poly(3-hydroxybutyrate-co-3-hydroxyvalerate)
PIA	Poly(itaconic acid)
PIB	Polyisobutylene
PIP	Polyisoprene
PLA	Poly(lactic acid)
PDLA	Poly-D-lactide
PLLA	Poly-L-lactide
PMMA	Poly(methyl methacrylate)
PP	Polypropylene
PS	Polystyrene
PTHF	Poly(tetramethylene ether) glycol
PTT	Poly(trimethylene terephthalate)
PU	Polyurethanes
PVA	Poly(vinyl acetate)
PVC	Poly(vinyl chloride)
UPR	Unsaturated polyester resin

Appendix H - References

Chapter 1 - Introduction

EurObserv'ER (2014) "Biofuels Barometer", Available at: http://www.energies-renouvelables.org/observ-er/stat_baro/observ/baro222_en.pdf

Nova Institute (2013) "Market Developments of and Opportunities for biobased products and chemicals", Authors: Dammer, L., Carus, M., Raschka, A. and Scholz, L., Available at: <http://bit.ly/1zZRmTk> [Accessed 08/07/14]

Chapter 2 - Mapping of the different possible pathways

de Jong, E, Higson A, Walsh P, Wellish M (2012) *Bio-based Chemicals; Value added products from biorefineries*, IEA Bioenergy, Task 42 Biorefinery. Available at: <http://www.ieabioenergy.com/wp-content/uploads/2013/10/Task-42-Biobased-Chemicals-value-added-products-from-biorefineries.pdf>

Harmsen, P. and M. Hackmann (2013) "Green building block for biobased plastics", Available at: http://www.iea-bioenergy.task42-biorefineries.com/upload_mm/d/7/6/54c63506-4be9-4892-b5b2-7b658c10305e_GreenBuildingBlocks%20for%20Biobased%20Plastics%20HR.pdf

Nova Institute (2013) "Market Developments of and Opportunities for biobased products and chemicals", Authors: Dammer, L., Carus, M., Raschka, A. and Scholz, L., Available at: <http://bit.ly/1zZRmTk> [Accessed 08/07/14]

Wettstein S.G., Alonso D.M., Gurbuz E.I. and Dumestic J.A. (2012) "A roadmap for conversion of lignocellulosic biomass to chemicals and fuels". *Current Opinion in Chemical Engineering* 1: 218–224

Chapter 3 - Assessment of technology development status

BioREF-iNTEG (2010) "Identification and market analysis of most promising added-value products to be co-produced with the fuels", Deliverable 2 total, FP7 project. Available at: http://www.bioref-integ.eu/fileadmin/bioref-integ/user/documents/D2total_including_D2.1_D2.2_D2.3_.pdf

Bio-TIC (2014) "Overcoming hurdles for innovation in industrial biotechnology in Europe: Non-Technological Roadmap: Draft 2", Available at: <http://www.industrialbiotech-europe.eu/bio-roadmaps/non-technological/>

de Guzman, D. (2013). "Bio-based Chemical Feedstocks", Available at: http://cpmaindia.com/pdf/apice2013_02_doris_de_guzman.pdf [Accessed 08/07/14]

de Jong, E and Gosselink, R.J.A. (2014) Ligno-cellulose-based chemical products. In book: *Bioenergy Research: Advances and Applications*, Chapter: 17, Publisher: Elsevier, Amsterdam, the Netherlands, Editors: Gupta, V.K., Kubicek, C.P., Saddler, J, Xu, F, Tuohy, M.G., pp.277-313

de Jong, E, Higson A, Walsh P, Wellish M (2012) *Bio-based Chemicals; Value added products from biorefineries*, IEA Bioenergy, Task 42 Biorefinery. Available at: <http://www.ieabioenergy.com/wp-content/uploads/2013/10/Task-42-Biobased-Chemicals-value-added-products-from-biorefineries.pdf>

Harmsen, P. and M. Hackmann (2013) "Green building block for biobased plastics", Available at: http://www.iea-bioenergy.task42-biorefineries.com/upload_mm/d/7/6/54c63506-4be9-4892-b5b2-7b658c10305e_GreenBuildingBlocks%20for%20Biobased%20Plastics%20HR.pdf

Jogdand (2014) "Current Status of bio-based chemicals", Available at:

<http://www.slideshare.net/induniva/current-status-of-biobased-chemicals>

Kretschmer, B., *et al.* (2013). "Recycling agricultural, forestry & food wastes and residues for sustainable bioenergy and biomaterials", Available at:

http://www.europarl.europa.eu/RegData/etudes/etudes/join/2013/513513/IPOL-JOIN_ET%282013%29513513%28SUM01%29_EN.pdf [Accessed 08/07/14]

Nexant (2014). "Renewable Chemicals & Materials Opportunity Assessment: Major Job Creation and Agricultural Sector Engine", Available at:

http://www.usda.gov/oce/reports/energy/USDA_RenewChems_Jan2014.pdf [Accessed 08/07/14]

Nova Institute (2012) "World-wide investments in bio-based chemicals". Available at http://www.nova-institut.de/download/Investments_list

Scottish Power Energy Networks (2007) "Innovation Funding Incentive: Annual Report", available at:

www.ofgem.gov.uk/Networks/Techn/NetwrkSupp/Innovat/ifi/Documents1/SP%20IFI%20Projects%200607%20-%20Issue%201.pdf

Weastra, S.R.O. (2013) "WP 8.1. Determination of market potential for selected platform chemicals: Itaconic acid, Succinic acid, 2,5-Furandicarboxylic acid", Report for BioConSepT FP7 project. Available at http://www.bioconcept.eu/wp-content/uploads/BioConSepT_Market-potential-for-selected-platform-chemicals_report1.pdf

Werpy, T. and Petersen, G. (2004) "Top value added chemicals from biomass: Volume I— Results of screening for potential candidates from sugars and synthesis gas", US DOE report produced by PNNL, NREL and EERE. Available at <http://www1.eere.energy.gov/bioenergy/pdfs/35523.pdf>

Chapter 5 – Case studies

All chapter 5 references containing website links were verified on 11/12/2014.

Acrylic acid

Clark, S. (2014) "Global acrylic acid market (Derivative types, applications, geography) - Size, share, global trends, company profiles, demand, insights, analysis, research, report, opportunities, segmentation and forecast, 2013 – 2020", Allied Market Research. Available at <http://www.alliedmarketresearch.com/acrylic-acid-market>

de Jong, E, Higson A, Walsh P, Wellish M. (2012) "Bio-based Chemicals; Value added products from biorefineries", IEA Bioenergy, Task 42 Biorefinery. Available at: <http://www.ieabioenergy.com/wp-content/uploads/2013/10/Task-42-Biobased-Chemicals-value-added-products-from-biorefineries.pdf>

Le, B. (2014) "Bio-based acrylic acid: Considerations for commercial viability and success", Nexant. Available at <http://www.nexant.com/blog/bio-based-acrylic-acid-considerations-commercial-viability-and-success>

Tullo, A.H. (2013) "Hunting for biobased acrylic acid", Chemical & Engineering News 91(46): 18-19. Available at <http://cen.acs.org/articles/91/i46/Hunting-Biobased-Acrylic-Acid.html?h=1016647717>

Adipic acid

Bigelow, B. V. (2014) "Verdezyne Gets \$48M to Advance Industrial Biotechnology in Malaysia", Xconomy.com. Available at <http://www.xconomy.com/san-diego/2014/04/29/verdezyne-gets-48m-to-advance-industrial-biotechnology-in-malaysia/>

- BioAmber (2011) "BioAmber and CELEXION Announce Exclusive Licensing Partnership". Available at <http://investor.bio-amber.com/2011-03-15-BioAmber-and-CELEXION-Announce-Exclusive-Licensing-Partnership>
- Biochemtex (2013) "A new era begins: Crescentino – World's first advanced biofuels facility". Available at <http://www.biofuelstp.eu/presentations/crescentino-presentation.pdf>
- Biochemtex (2014) "Cellulosic Ethanol Proesa". Available at <http://www.biochemtex.com/proesa>
- BioFPR (2014) "New Interview - Read about the latest technological developments in DSM's bio-based chemical portfolio". Available at http://www.biofpr.com/details/news/5862411/New_Interview_-_Read_about_the_latest_technological_developments_in_DSMs_bio-bas.html
- BiofuelsDigest (2011) "DSM, BP invest in Verdezyne". Available at <http://www.biofuelsdigest.com/bdigest/2011/05/10/dsm-bp-invest-in-verdezyne/>
- Boussie, T. (2013) "Scale-up and commercialization of bio-based adipic acid and HMD", Rennovia, 4th Biobased Chemicals Commercialization & Partnering Meeting. Available at <http://www.rennovia.com/LinkClick.aspx?fileticket=D7OAWvdK8YY%3D&tabid=62>
- Chemicals-technology.com (n.d.) "Verdezyne adipic acid pilot plant, Carlsbad, California, United States of America". Available at <http://www.chemicals-technology.com/projects/verdezyne-adipic-acid-plant-california/>
- De Bari, I. (2014) "Biorefineries and green chemistry: Italian country report", ENEA Trisaia Research Center. Available at http://www.iea-bioenergy.task42-biorefineries.com/upload_mm/5/0/1/6191bfee-277e-449c-8458-8168fe31894f_de_bari_italy_country_report_2014.pdf
- De Guzman, D. (2011) "AE Biofuels enters renewable chems", ICIS Chemical Business. Available at <http://www.icis.com/blogs/green-chemicals/2011/11/ae-biofuels-enters-renewable-c/>
- De Guzman, D. (2011) "BioAmber enters adipic acid", ICIS Chemical Business. Available at <http://www.icis.com/blogs/green-chemicals/2011/03/bioamber-enters-adipic-acid/>
- De Guzman, D. (2013) "Rennovia produces 100% bio-based nylon". Available at <http://greenchemicalsblog.com/2013/10/02/rennovia-produces-100-bio-based-nylon/>
- Genomatica (n.d.) "Nylon intermediates: extensive IP, early validation". Available at <http://www.genomatica.com/products/nylon-intermediates/#sthash.XcVXkvpD.dpu>
- Grand View Research (2014) "Adipic acid market analysis and segment forecasts to 2020". Available at <http://www.grandviewresearch.com/industry-analysis/adipic-acid-market>
- Grand View Research (n.d.) "Global Adipic Acid Industry to 2020 – Market Estimate, Competitive Landscape, Industry Size". Available at http://www.academia.edu/6467449/Global_Adipic_Acid_Industry_to_2020_-_Market_Estimate_Competitive_Landscape_Industry_Size
- Harmsen, P. and Hackmann, M. (2013) "Green building blocks for biobased plastics: Biobased processes and market development". Available at <http://www.groenegrondstoffen.nl/downloads/Boekjes/16GreenBuildingblocks.pdf>
- ICIS Chemical Business (2010) "Green chemicals: Bio-based adipic acid to enter market in 2014". Available at <http://www.icis.com/resources/news/2010/09/27/9396199/green-chemicals-bio-based-adipic-acid-to-enter-market-in-2014/>
- ICIS Chemical Business (2011) "Green Chemicals: DSM adds adipic acid to bio-based chemicals portfolio". Available at <http://www.icis.com/resources/news/2011/10/10/9498186/green-chemicals-dsm-adds-adipic-acid-to-bio-based-chemicals-portfolio/>

IHS (2012) "Report 284: Bio-Based Adipic Acid". Available at

<http://www.ihs.com/products/chemical/technology/pep/bio-based-adipic-acid.aspx>

Lane, I. (2014) "Rennovia and Johnson Matthey Davy Technologies to collaborate for glucaric acid, adipic acid project", BiofuelsDigest. Available at <http://www.biofuelsdigest.com/bdigest/2014/03/23/rennovia-and-johnson-matthey-davy-technologies-to-collaborate-for-glucaric-acid-adipic-acid-project/>

Lane, J. (2013) "Verdezyne: Biofuels Digest's 5-Minute Guide", BiofuelsDigest. Available at <http://www.biofuelsdigest.com/bdigest/2013/01/30/verdezyne-biofuels-digests-5-minute-guide/>

Lane, J. (2014) "ADM invests \$25M in Rennovia: the complete story", BiofuelsDigest. Available at <http://www.biofuelsdigest.com/bdigest/2014/02/12/adm-invests-25m-in-rennovia-the-complete-story/>

Murphy, V. (2013) "Sustainable Cost-Advantaged Chemical Intermediates for 100% Bio-Based Nylon-6,6", Rennovia, bioplastek forum 2013. Available at

<http://www.rennovia.com/LinkClick.aspx?fileticket=SbQO8hcNOW8%3D&tabid=62>

PlasticsToday (2011) "Engineered plastics' global demand back on the rise". Available at <http://www.plasticstoday.com/articles/engineered-plastics-global-demand-back-on-rise>

Schen, L., Haufe, J. and Patel, M.K. (2009) "Product overview and market projection of emerging bio-based plastics", PRO-BIP 2009 report. Available at http://en.european-bioplastics.org/wp-content/uploads/2011/03/publications/PROBIP2009_Final_June_2009.pdf

Tecnon OrbiChem (2013) "Bio-Materials & intermediates including Bio-Based chemicals, Bio-polymers & their petrochemical equivalents", Issue No. 000. Available at http://www.orbichem.com/userfiles/Promotions/bm_000.pdf

The Chemical Company (n.d.) "Adipic acid overview". Available at <https://www.thechemco.com/chemical/adipic-acid/>

Transparency Market Research (2012) "Synthetic And Bio-Based Adipic Acid Market - Global Industry Analysis, Market Size, Share, Growth And Forecast, 2012 – 2018" Available at <http://www.transparencymarketresearch.com/synthetic-and-bio-based-adipic-acid.html>

Van Duuren, J.B.J.H., Brehmer, B., Mars, A.E., Eggink, G., dos Santos, V.M., Sanders, J.P.M. (2011) "A limited LCA of bio-adipic acid: Manufacturing the nylon-6,6 precursor adipic acid using the benzoic acid degradation pathway from different feedstocks", Biotechnology and Bioengineering 108(6): 1298-1306.

Venture Capital Post (2014) "The agricultural titan of US, ADM invests \$25M in Rennovia". Available at <http://www.vcpost.com/articles/21870/20140224/us-agricultural-giant-adm-invests-25m-in-rennovia.htm>

Verdezyne, Inc. (2013) "Verdezyne Collaborates With Malaysian Biotechnology Corporation To Ensure Opportunities In Asia". Available at http://verdezyne.com/wp-content/uploads/Verdezyne_BiotechCorppressreleaselatest6.17.18-FINAL.pdf

Verdezyne, Inc. (n.d.) "Investors". Available at <http://verdezyne.com/company/investors/>

1,4-Butanediol (BDO)

Burk, M.J. (2010) "Sustainable production of industrial chemicals from sugars", International Sugar Journal 112(1333): 30-35. Available at http://www.genomatica.com/uploads/pdfs/ISJ_markburke.pdf

De Guzman, D. (2013) "Bio-BDO commercialization race is on", Green Chemicals Blog. Available at <http://greenchemicalsblog.com/2013/06/12/bio-bdo-commercialization-race-is-on/>

European Plastics News (2013) "Novamont BDO plant to come on stream in 2014". Available at <http://www.europeanplasticsnews.com/subscriber/headlines2.html?id=3637&ks=1>

- F.O. Licht (2011) "Genomatic enters strategic partnership with M&G". Available at <http://renewablechemicals.agra-net.com/genomatica-enters-strategic-partnership-with-mg/>
- Genomatica (2013) "BASF licenses Genomatica's GENO BDO process; now producing". Available at <http://www.genomatica.com/partners/basf/>
- Genomatica (2012) "BDO plant in Europe". Available at <http://www.genomatic.com/partners/novamont>
- Genomatica (2012) "SM approves BDO for use in Arnitel product lines". Available at <http://www.genomatica.com/partners/dsm-pbt/>
- Grand View Research (2014) "1,4-butanediol market analysis and segment forecasts to 2020". Available at <http://www.grandviewresearch.com/industry-analysis/1-4-butanediol-market>
- Grand View Research (2014) "Global 1,4-butanediol market expected to reach USD 6,947.1 million by 2020". Available at <http://www.grandviewresearch.com/press-release/global-1-4-butanediol-market>
- Ingram, A. and Le, B. (2013) "1,4-butanediol/tetrahydrofuran (BDO/THF)", Nexant Chemsystems. Available at http://thinking.nexant.com/sites/default/files/report/field_attachment_abstract/201304/2012_3_abs.pdf
- Lane, J. (2013) "4C-able future: Biobased butanol, butadiene and BDO are having a hot year", Biofuels Digest. Available at <http://www.biofuelsdigest.com/bdigest/2013/08/21/4c-able-future-biobased-butanol-butadiene-and-bdo-are-having-a-hot-year/>
- Markets and Markets (2012) "1,4-butanediol (BDO) market by technology (Reppe process, Davy process, Butadiene process, Propylene Oxide process & others), applications, & geography: Global industry trends & forecasts to 2017". Available at <http://www.marketsandmarkets.com/Market-Reports/1-4-butanediol-market-685.html>
- Nova Institute (2013) "Market study on bio-based polymers in the world: Capacities, production and applications: Status quo and trends towards 2020". Press release available at http://www.bio-based.eu/market_study/media/files/13-07-24PRMarketStudynova.pdf
- Tecnon OrbiChem (2013) "Chem-Net facts: 1,4-butanediol". Available at http://www.orbichem.com/userfiles/CNF%20Samples/bdo_13_11.pdf
- Toray (2013) "Toray succeeds in production of bio-based PBT and part samples". Available at <http://www.toray.com/news/pla/nr130425.html>
- United States Environmental Protection Agency (2011) "2011 Greener synthetic pathways award: Genomatica". Available at <http://www2.epa.gov/green-chemistry/2011-greener-synthetic-pathways-award>
- Weastra, S.R.O. (2013) "WP 8.1. Determination of market potential for selected platform chemicals: Itaconic acid, Succinic acid, 2,5-Furandicarboxylic acid", Report for BioConSepT FP7 project. Available at http://www.bioconcept.eu/wp-content/uploads/BioConSepT_Market-potential-for-selected-platform-chemicals_report1.pdf
- Farnesene*
- Amyris (2014) "Amyris receives green chemistry innovation award from U.S. Environmental Protection Agency". Available at <http://www.amyris.com/amyris-receives-green-chemistry-innovation-award-from-u-s-environmental-protection-agency/>
- Amyris (2014) "Braskem joins Amyris and Michelin to accelerate the industrialization and commercialization of renewable isoprene". Available at <http://www.amyris.com/braskem-joins-amyris-and-michelin-to-accelerate-the-industrialization-and-commercialization-of-renewable-isoprene/>
- Amyris (2014) "Our company". Available at <http://www.amyris.com/Company/151/BusinessStrategy>
-

Amyris (2013) "Breaking the barriers with breakthrough jet fuel solutions", Paris Air Show 2013. Available at http://www.alternativefuelsworldwide.com/presentations/TOTAL%20AMYRIS%20presentation%20Paris%20Air%20Show%2020-25%20min_v2.pdf

Bloomberg (2011) "Amyris partners with Kuraray to develop renewable polymers". Available at <http://www.bloomberg.com/apps/news?pid=newsarchive&sid=asX64.ZxtZAM>

Chatsko, M. (2014) "Should Amyris investors fear Intrexon's farnesene?", The Motley Fool. Available at <http://www.fool.com/investing/general/2014/07/07/should-amyris-investors-fear-intrexons-farnesene.aspx>

Chatsko, M. (2014) "What will Amyris gain and sacrifice to court tire manufacturers for expansion?", The Motley Fool. Available at <http://www.fool.com/investing/general/2014/05/01/what-will-amyris-gain-and-sacrifice-to-court-tire.aspx>

Chromatin (2014) "Chromatin, Inc. announces production of farnesene in Sorghum". Available at <http://www.chromatininc.com/news/Chromatin-Inc.-Announces-Production-of-Farnesene-in-Sorghum>

Green Air (2014) "Lufthansa operates commercial flight using new sugar-based biofuel and signs jatropha agreement". Available at <http://www.greenaironline.com/news.php?viewStory=1981>

Intrexon (2014) "Intrexon's industrial products division achieves bioconversion of methane to farnesene". Available at <http://investors.dna.com/phoenix.zhtml?c=249599&p=irol-newsArticle&ID=1943576&highlight=>

Lane, J. (2014) "Amyris' date with destiny: Better late than never". Available at <http://www.altenergystocks.com/archives/biomass/biochemicals/>

Mills, S.R. (2013) "Amyris investor presentation", 2013 Credit Suisse Small & Mid Cap Conference Future of Energy Track. Available at <http://files.shareholder.com/downloads/ABEA-4QL2IU/0x0x691918/2aaeadc4-124f-4730-b72f-10030d9624fa/Investor-Presentation.pdf>

National Advanced Biofuels Consortium (2012) "Fermentation of lignocellulosic sugars process strategy". Available at http://www.nabcprojects.org/fermentation_lignocellulosic_sugar.html

Quon, K. (2014) "Amyris advances, but at what cost?", Seeking Alpha. Available at <http://seekingalpha.com/article/2051433-amyris-advances-but-at-what-cost>

Schofer, S.J. *et al.* (2014), "Biofene, a renewable monomer for elastomer materials with novel properties: Polymer development, characterisation and use", Rubber World. Available at http://digital.ipcprints.com/article/Biofene,_a_renewable_monomer_for_elastomer_materials_with_novel_properties%3A_Polymer_development,_characterization_and_use/1785778/221347/article.html

Tutor Perini Corporation (2014), Jefferies 2014 Global Industrials Conference. Available at http://investors.tutorperini.com/files/doc_presentations/2014/TPC%20Jefferies%202014%20Global%20Industrials%20Conference%20Presentation_v001_b289ex.pdf

U.S. Department of Energy (2012) "Amyris integrated biorefinery". Available at http://www1.eere.energy.gov/bioenergy/pdfs/ibr_arra_amyris.pdf

Voegele, E. (2014) "Amyris reports reduced farnesene production costs in 2013 results", Biomass Magazine. Available at <http://biomassmagazine.com/articles/10056/amyris-reports-reduced-farnesene-production-costs-in-2013-results>

2,5-Furandicarboxylic Acid (FDCA)

Avantium (2014) "Avantium raises €36M investment from Swire Pacific, The Coca-Cola Company, Danone and ALPLA". Available at <http://avantium.com/news/Avantium-Raises--36M-Investment-from-Swire-The-Coca-Cola-Company-Danone-and-ALPLA>

Deligio, T. (2014) "100% biobased polyester charts course to commercialization", *Plastics Technology*. Available at <http://www.ptonline.com/blog/post/100-biobased-polyester-charts-course-to-commercialization#/cdn/cms/Avantium%20Bottles.jpg>

Eerhart, A.J.J., Faaij, A.P.C. and Patel, M.K. (2011) "Energy and GHG emission balance of furanics-based biopolyesters". Available at ftp://ftp.geog.uu.nl/pub/posters/2011/Energy_and_GHG_emission_balance_of_Furanics-based_biopolyesters-Eerhart_Faaij_Patel-June2011.pdf

European Food Safety Authority (2014) "Scientific Opinion on the safety assessment of the substance, furan-2,5-dicarboxylic acid, CAS No 3238-40-2, for use in food contact materials". Available at <http://www.efsa.europa.eu/en/efsajournal/pub/3866.htm>

Food Ingredients 1st (2013) "Purac to acquire BIRD Engineering B.V.". Available at <http://www.foodingredientsfirst.com/news/Purac-to-Acquire-BIRD-Engineering-BV.html>

Grand View Research (2014) "Furandicarboxylic acid (FDCA) market potential analysis and segment forecasts to 2020". Available at <http://www.grandviewresearch.com/industry-analysis/FDCA-Industry>

Grand View Research (2014) "World FDCA (furandicarboxylic acid) market expected to reach USD 498.2 million by 2020". Available at <https://www.prbuzz.com/energy/244843-world-fdca-furandicarboxylic-acid-market-expected-to-reach-usd-498-2-million-by-2020-grand-view-research-inc.html>

Harmsen, P. and Hackmann, M. (2013). "Green building blocks for bio-based plastics: Biobased processes and market development". Available at <http://www.groenegrondstoffen.nl/downloads/Boekjes/16GreenBuildingblocks.pdf>

Hoetmer, G. (2013) "Corbion biochemicals strategy". Available at <http://www.corbion.com/media/168355/cmd-2013-biochemicals.pdf>

Lane, J. (2014) "Avantium: Biofuels Digest's 2014 5-minute guide", *Biofuels Digest*. Available at <http://www.biofuelsdigest.com/bdigest/2014/02/25/avantium-biofuels-digests-2014-5-minute-guide/>

Schäfer, T (2012) "Biological solutions in a chemical world", *Green Polymer Chemistry 2012*. Available at <http://www.slideshare.net/thomasschafer5688476/biological-solutions-in-a-chemical-world-green-polymer-chemistry-2012>

Voegele, E. (2014) "AVA Biochem produces renewable 5-HMF", *Biomass Magazine*. Available at <http://biomassmagazine.com/articles/10001/ava-biochem-produces-renewable-5-hmf>

Weastra, S.R.O. (2013) "WP 8.1. Determination of market potential for selected platform chemicals: Itaconic acid, Succinic acid, 2,5-Furandicarboxylic acid", Report for BioConSepT FP7 project. Available at http://www.bioconsept.eu/wp-content/uploads/BioConSepT_Market-potential-for-selected-platform-chemicals_report1.pdf

Whitworth, J. (2014) "Avantium passes EFSA food contact application". Available at <http://www.foodproductiondaily.com/Innovations/EFSA-panel-backs-monomer-that-produces-PEF>

Isobutene

Butamax (2014) "About Butamax advanced biofuels". Available at <http://www.butamax.com/biofuel-company.aspx>

Butamax (2014) "Butamax and Highwater Ethanol complete phase 1 of biobutanol retrofit project including installation of novel corn oil separation technology. Available at http://www.butamax.com/Portals/0/pdf/2_ButamaxandHighwaterEthanolCompletePhase1ofBiobutanolRetrofitProject.pdf

China New Energy (n.d.) "Lianyungang Lianhua Chemicals Co., Ltd". Available at http://en.zkty.com.cn/en/projects.asp?n_type1=case&case_id=270&cur=Biobutanol+production+from+the+mixed+material+of+cassava+and+corn

De Guzman, D. (2014) "Global Bioenergies commercialization in momentum". Available at <http://greenchemicalsblog.com/2014/08/11/global-bioenergies-commercialization-in-momentum/>

De Guzman, D. (2013) "Global Bioenergies partners with Arkema". Available at <http://greenchemicalsblog.com/2013/06/08/global-bioenergies-partners-with-arkema/>

De Guzman, D. (2010) "Lanxess invests in bio-butanol firm Gevo". Available at <http://www.icis.com/blogs/green-chemicals/2010/05/lanxess-invests-in-bio-butanol/>

Gevo (2014) "Our business: Production". Available at <http://www.gevo.com/about/our-business/production-sites/>

Global Bioenergies (2014) "Applications: Olefin market". Available at http://www.global-bioenergies.com/index.php?option=com_content&view=article&id=73&Itemid=172&lang=en

Global Bioenergies (2014) "FAQs". Available at http://www.global-bioenergies.com/index.php?option=com_content&view=article&id=81&Itemid=185&lang=en

Global Bioenergies (2014) "Fermentation pilot received in Pomacle ". Available at http://www.global-bioenergies.com/communiques/140722_pr_en.pdf

Global Bioenergies (2012) "Global Bioenergies on track with the development schedule of its bio-isobutene production process ". Available at http://www.global-bioenergies.com/cp/cp_120502_production_isobutene_uk.pdf

Harmsen, P. and Hackmann, M. (2013). "Green building blocks for bio-based plastics: Biobased processes and market development". Available at <http://www.groenegrondstoffen.nl/downloads/Boekjes/16GreenBuildingblocks.pdf>

Lanxess (2011) "Lanxess steps up commitment to biobased raw materials". Available at <http://lanxess.com/en/corporate/about-lanxess/company-news/lanxess-steps-up-commitment-to-biobased-raw-materials/>

Speciality Chemicals Magazine (2011) "Lanxess furthers biobased isobutene focus". Available at http://www.specchemonline.com/news/view/lanxess-furthers-biobased-isobutene-focus#.VHL8szSG_Sh

Stefan, D. (ed.) (2014) "Linde to build bio-based isobutene pilot plant for Global Bioenergies". Available at http://www.process-worldwide.com/engineering_construction/plant_design/basic_detail_engineering/articles/437380/

Transparency Market Research (2013) "Isobutene market – global industry analysis, size, share, growth, trends and forecast, 2013 – 2019". Available at <http://www.transparencymarketresearch.com/isobutene-market.html>

van Leeuwen, N.M., van der Wulp, A.M., Duijnste, I., van Maris, A.J.A., Straathof, A.J.J. (2012) "Fermentative production of isobutene", Applied Microbiology and Biotechnology 93(4): 1377–1387.

Polyhydroxyalkanoates (PHAs)

Biocycle (n.d.) "A new gold rush" Available at http://www.biocycle.com.br/imprensa_ing_02.htm

Biomer (n.d.) "Injection molded articles made of renewable raw materials!". Available at <http://www.biomer.de/IndexE.html>

Bio-on (n.d.) "Home". Available at <http://www.bio-on.it/index.php?lin=inglese>

Bioplastics.org (n.d.) "Bioplastic types – polyhydroxyalkanoates". Available at <http://www.bioplastics.org/en/information--knowledge-a-market-know-how/bioplastic-types/polyhydroxyalkanoates>

Chen G.Q. (ed.) 2009 "Plastics from Bacteria: Natural Functions and Applications", Microbiology Monographs 14(1): 17-36.

De Guzman, D. (2013) "Metabolix expands collaboration with Samsung Fine Chemicals". Available at <http://greenchemicalsblog.com/2013/08/01/metabolix-expands-collaboration-with-samsung-fine-chemicals/>

De Guzman, D. (2013) "Newlight, Biomer on PHA deal". Available at <http://greenchemicalsblog.com/2013/03/12/newlight-biomer-on-pha-deal/>

European Plastics News (2013) "Global PP market to reach 62.4 million metric tonnes". Available at <http://www.plasticsnews.com/article/20130909/NEWS/130909948/global-pp-market-to-reach-62-4-million-metric-tons#>

"Global polypropylene market is expected to cross US\$124 bln in 2019" (2014). Available at [http://www.plastemart.com/Plastic-Technical-Article.asp?LiteratureID=2072&Paper=global-polypropylene-PP-market-expected-to-cross-US\\$124-billion-in-2019](http://www.plastemart.com/Plastic-Technical-Article.asp?LiteratureID=2072&Paper=global-polypropylene-PP-market-expected-to-cross-US$124-billion-in-2019)

Hermann, B. G., Blok, K., and Patel, M. K. (2007), "Producing bio-based bulk chemicals using industrial biotechnology saves energy and combats climate change", Environmental Science and Technology 41(1):7915-7921.

Kim, S. and Dale, B.E. (2008), "Energy and greenhouse gas profiles of polyhydroxybutyrates derived from corn grain: A life cycle perspective", Environmental Science and Technology 42(20):7690-7695.

Koller, M., Hesse, P., Kutschera, C., Bona, R., Nascimento, S.O., Agnelli, J.A., Braunnegg, G. (2009) "Sustainable embedding of the bioplastic Poly-(3-Hydroxybutyrate) into the sugarcane industry: Principles of a future-oriented technology in Brazil", The Handbook of Environmental Chemistry, Springer, Berlin. Available at <http://bit.ly/1u71Qwa>

Metabolix (2012) "Metabolix signs letter of intent with Antibióticos for Production of Mirel Biopolymer Resin". Available at <http://ir.metabolix.com/releasedetail.cfm?ReleaseID=695943>

PHBottle (n.d.) "The partnership". Available at <http://www.phbottle.eu/socios.htm>

Platts (n.d.) "Platts global polypropylene (PP) price index". Available at <http://www.platts.com/news-feature/2012/pgpi/polypropylene>

"4.4 Polyhydroxyalkanoates (Including Polyhydroxybutyrate (PHB) and Copolymers)" (n.d.). Available at <http://info.smithersrapra.com/downloads/chapters/Mouldable%20Particle%20Section%204.4.pdf>

PRNewsWire (2014) "Global polypropylene market is expected to reach USD 124.01 billion in 2019: Transparency Market Research". Available at <http://www.prnewswire.com/news-releases/global-polypropylene-market-is-expected-to-reach-usd-12401-billion-in-2019-transparency-market-research-247241851.html>

Ravenstijn, J. (2014) "PHA.....Is it here to stay?". Available at <http://www.kcpk.nl/algemeen/bijeenkomsten/presentaties/20140508-jan-ravenstijn-pha-is-it-here-to-stay>

Smock, D. (2013), "NN, Anoxkaldnes move closer to PHA plant in the Netherlands". Available at <http://www.themoldingblog.com/2013/03/13/knn-anoxkaldnes-move-closer-to-pha-plant-in-the-netherlands/>

Snijder, M. (2012) "PHB resin and compounds from TGBM - biobased and biodegradable materials for film-, foil-, foam-, fibre- and injection moulding applications", 5th International Congress on Bio-based Plastics and Composites, Köln. Available at www.nova-institut.de/download/MartinSnijder-GreenGran

Tianjin GreenBio Materials (n.d.) "Sogreen P (3,4HB) Resin 00A". Available at <http://www.tjgreenbio.com/en/Product.aspx?cid=50&title=Resin%20Material>

Polyethylene

Braskem (n.d.) "Braskem". Available at <http://ciber.gatech.edu/Braskem.pdf>

Braskem (n.d.) "Green products". Available at <http://www.braskem.com.br/site.aspx/green-products-USA>

Braskem (n.d.) "I'm Green™ polyethylene". Available at <http://www.braskem.com/site.aspx/lm-greenTM-Polyethylene>

European Bioplastics (2014) "Fact sheet - Benefits of biobased rigid packaging". Available at http://en.european-bioplastics.org/wp-content/uploads/2013/publications/EuBP_FS_Rigid%20Packaing_March2013.pdf

European Bioplastics (2014) "Material innovations – biobased low-density polyethylene", EP Bulletin 2014(1). Available at <http://en.european-bioplastics.org/blog/2014/02/11/material-innovations-biobased-low-density-polyethylene/>

Gotro, J. (2013) "Bio polyethylene: Drop-in replacement". Available at <http://polymerinnovationblog.com/bio-polyethylene-drop-in-replacement/>

Grand View Research (2014) "Bio-based polyethylene (PE) market analysis, market size, application analysis, regional outlook, competitive strategies and forecasts, 2014 to 2020". Available at <http://www.grandviewresearch.com/industry-analysis/bio-based-polyethylene-pe-market>

Harmsen, P. and Hackmann, M. (2013). "Green building blocks for bio-based plastics: Biobased processes and market development". Available at <http://www.groenegrondstoffen.nl/downloads/Boekjes/16GreenBuildingblocks.pdf>

IRENA (2013) "Production of bio-ethylene: Technology brief". Available at http://www.irena.org/DocumentDownloads/Publications/IRENA-ETSAP%20Tech%20Brief%2013%20Production_of_Bio-ethylene.pdf

Jagger, A. (2011) "APLA: Brazil grows bio-based materials effort". Available at <http://www.icis.com/Articles/2011/11/07/9505416/APLA-Brazil-grows-bio-based-materials-effort.html>

Lauzon, M. (2013) "Tetra Pak using bio-based polyethylene". Available at <http://www.plasticsnews.com/article/20130626/NEWS/130629946/tetra-pak-using-bio-based-polyethylene>

Lepoutre, P. (n.d.) "The manufacture of polyethylene". Available at <http://nzc.org.nz/ChemProcesses/polymers/10J.pdf>

Peoples, O. (2013) "Bioplastics: Global status", GPEC, New Orleans. Available at <http://sperecycling.org/sites/sperecycling.org/files/papers/GPEC2013/l2peoples.pdf>

Plastemart.com (n.d.) "Biobased polymers will triple in capacity from 2011 to 12 million tons by 2020". Available at <http://www.plastemart.com/Plastic-Technical-Article.asp?LiteratureID=1978&Paper=biobased-polymers-bioploymers-triple-capacity-by-2020-12-million-tons>

Sapp, M. (2013) "Dow and Mitsui postpone plans for green plastic but still OK for ethanol". Available at <http://www.biofuelsdigest.com/bdigest/2013/01/14/dow-and-mitsui-postpone-plans-for-green-plastic-but-still-ok-for-ethanol/>

Sugarcane.org (2014) "Bioplastics". Available at <http://sugarcane.org/sugarcane-products/bioplastics>

Tetra Pak (2011) "Nestlé, Tetra Pak and Braskem launch package with a cap using renewable raw material". Available at <http://www.tetrapak.com/about-tetra-pak/press-room/news/cap-renewablerawmaterial>

Toon, H. (2012) "Environmental, social and economic sustainability of biobased plastics, bio-polyethylene from Brazil and polylactic acid from the U.S.". Available at http://ivem.eldoc.ub.rug.nl/FILES/ivempubs/dvrapp/EES-2012/EES-2012-128T/EES-2012-128T_ToonHaer.pdf

Toyota Tsusho Corporation (2013) "What's green polyethylene". Available at <http://green-polyethylene.com/whats.html>

Weiss, J. (2014) "Most innovative companies 2014: 41. Braskem". Available at <http://www.fastcompany.com/most-innovative-companies/2014/braskem>

Ziem, S., Chudziak, C., Taylor, R., Bauen, A., Murphy, R., Guo, M., Akhurst, M. (2013) "Environmental assessment of Braskem's biobased PE resin: Summary of the life cycle assessment, land-use change and water footprint reports". Available at <http://www.braskem.com.br/Portal/Principal/Arquivos/ModuloHTML/Documentos/1204/20131206-enviro-assessment-summary-report-final.pdf>

Polylactic acid

Business Wire (2013) "Research and markets: China lactic acid and derivative industry report, 2013". Available at <http://www.businesswire.com/news/home/20130905005691/en/Research-Markets-China-Lactic-Acid-Derivative-Industry#.VCmkFmddV1Y>

Cellulac (2013) "Cellulac to produce up to 100,000 tonnes of lactic acid per year". Available at <http://cellulac.co.uk/en/aenean-nec-eros/cellulac-to-produce-up-to-100000-tonnes-of-lactic-acid-per-year/>

Corbion Purac (2013) "High heat PLA: Unlocking bioplastic potential for durable applications". Available at http://www.corbion.com/media/77166/corbionpurac_high_heat_pla_leaflet.pdf

Datta, R. and Henry, M., 2006, Lactic acid: recent advances in products, processes and technologies - a review, *Journal of Chemical Technology and Biotechnology*, vol. 81, no. 7, pp. 1119-1129.

de Jong, E, Higson A, Walsh P, Wellish M. (2012) "Bio-based Chemicals; Value added products from biorefineries", IEA Bioenergy, Task 42 Biorefinery. Available at: <http://www.ieabioenergy.com/wp-content/uploads/2013/10/Task-42-Biobased-Chemicals-value-added-products-from-biorefineries.pdf>

Direvo (2013), "Direvo completes laboratory scale development of low cost lactic acid production technology". Available at http://www.direvo.com/fileadmin/user_upload/DIREVO-PressRelease_No6_2013.pdf

European Bioplastics (2013) "Thyssen Krupp invests into production processes for biodegradable plastics", EP Bulletin 2013(4). Available at <http://en.european-bioplastics.org/blog/2013/09/09/thyssen-krupp-invests-into-production-processes-for-biodegradable-plastics/>

Food Product Design (2012) "Jungbunzlauer begins lactic acid production". Available at <http://www.foodproductdesign.com/News/2012/01/Jungbunzlauer-Begins-Lactic-Acid-Production.aspx?topic=lactic-acid>

F.O. Lichts (n.d.) "Thai PTT acquires 50% stake in NatureWorks". Available at <http://renewablechemicals.agra-net.com/thai-ptt-acquires-50-stake-in-natureworks/>

Futero (n.d.) "Technology". Available at <http://www.futero.com/technology.html>

Galactic (2014) "Our history". Available at <http://www.lactic.com/en-us/aboutus/ourhistory.aspx>

“Global polypropylene market is expected to cross US\$124 bln in 2019” (2014). Available at [http://www.plastemart.com/Plastic-Technical-Article.asp?LiteratureID=2072&Paper=global-polypropylene-PP-market-expected-to-cross-US\\$124-billion-in-2019](http://www.plastemart.com/Plastic-Technical-Article.asp?LiteratureID=2072&Paper=global-polypropylene-PP-market-expected-to-cross-US$124-billion-in-2019)

GlycosBio (2010) “Glycos Biotechnologies announces successful production of biochemicals in pilot plant size environment”. Available at <http://www.glycosbio.com/glycos-biotechnologies-announces-successful-production-of-biochemicals-in-pilot-plant-size-environment/>

Grand View Research (2013) “Lactic acid And poly lactic acid (PLA) market analysis by application (packaging, agriculture, transport, electronics, textiles) and segment forecasts to 2020”. Available at <http://www.grandviewresearch.com/industry-analysis/lactic-acid-and-poly-lactic-acid-market>

Hermann, B. G., Blok, K., and Patel, M. K. (2007), “Producing bio-based bulk chemicals using industrial biotechnology saves energy and combats climate change”, *Environmental Science and Technology* 41(1):7915-7921.

Inkinen, S. (2013) “The journey of poly(lactic acid):From commodities to special applications”. Available at <http://www.funmat.fi/SABmeeting2013/42-Inkinen.pdf>

Jamshidian et al. (2010) “Poly-lactic acid: Production, applications, nanocomposites, and release studies”, *Comprehensive Reviews in Food Science and Food Safety* 9(5): 552-571.

Jonker, J. (2013) “Corbion PLA”. Available at <http://www.corbion.com/media/168367/cmd-2013-pla.pdf>

Khalid, K. (2011) “A review of novel feedstock for the production of polylactic acid (PLA)”, *Journal of Chemistry* 2(1): 11-16. Available at <http://icoci.org/index.php/joc/article/viewFile/116/107><http://www.icis.com/blogs/green-chemicals/2012/03/increasing-bioplastic-capacity/>

Lancaster, M. (2010) “Green chemistry: An introductory text”, 2nd edn, The Royal Society of Chemistry, Cambridge.

Lane, J. (2014) “All-renewable plastic bottles creep closer: Gevo shipping renewable PX to Toray”. Available at <http://www.biofuelsdigest.com/bdigest/2014/06/02/all-renewable-plastic-bottles-creep-closer-gevo-shipping-renewable-px-to-toray/>

Mehta et al. (2005) “Synthesis of poly(lactic acid): A review”, *Journal of Macromolecular Science, Part C: Polymer Reviews* 45(4): 325-349.

Morales, J. (2014) “North American resin markets trends”. Available at <http://westernplastics.org/wp-content/uploads/2014/01/Joel-Morales-Presentation.pdf>

NatureWorks (2013) “NatureWorks and 3Dom collaborate to bring Ingeo PLA filament to the 3D printing market”. Available at <http://www.natureworkslc.com/News-and-Events/Press-Releases/2013/12-10-13-NatureWorks-3DOM-collaborate-on-Ingeo-PLA-filament-for-3D-printing>

NatureWorks (2011) “NatureWorks attracts \$150 million equity investment from leading Thailand company PTT Chemical”. Available at <http://www.natureworkslc.com/News-and-Events/Press-Releases/2011/10-12-11-NatureWorks-attracts-PTT-Chemical-equity-investment>

NatureWorks (2010) “Eco-profile”. Available at <http://www.natureworkslc.com/the-ingeo-journey/Eco-Profile-and-LCA/Eco-Profile.aspx#GHG>

NNFCC (2011) “Factsheet: Lactic acid”. Available at https://www.google.co.uk/url?sa=t&rct=j&q=&esrc=s&source=web&cd=2&cad=rja&uact=8&ved=0CCgQFjAB&url=http%3A%2F%2Fwww.nnfcc.co.uk%2Fpublications%2Fnnfcc-renewable-chemicals-factsheet-lactic-acid%2Fat_download%2Ffile&ei=VuMrVNSIH-Hd7gbDh4DIAw&usq=AFQjCNGYPVhmJd-9FOGnbj9y48gnv9IvLg&sig2=b1OAKUPo8A9fLhcgLq3mUw&bvm=bv.76477589,d.ZGU

Nova Institute (2013) "Market study on bio-based polymers in the world: Capacities, production and applications: Status quo and trends towards 2020". Press release available at http://www.bio-based.eu/market_study/media/files/13-07-24PRMarketStudynova.pdf

Nova Institute (2012) "World-wide investments in bio-based chemicals". Available at http://www.nova-institut.de/download/Investments_list

Plaxica (2014) "Technology demonstration". Available at <http://www.plaxica.com/technology/technology-demonstration/>

PRNewsWire (2014) "Global polypropylene market is expected to reach USD 124.01 billion in 2019: Transparency Market Research". Available at <http://www.prnewswire.com/news-releases/global-polypropylene-market-is-expected-to-reach-usd-12401-billion-in-2019-transparency-market-research-247241851.html>

Sall, K. (2014) "Corbion Purac collaboration taking bioplastics into even more uses". Available at <http://www.plasticsnews.com/article/20141017/NEWS/141019943/corbion-purac-collaboration-taking-bioplastics-into-even-more-uses>

Tin Sin, L., Rahmat, A.R., Rahman, W.A.W.A. (2012) "Overview of poly(lactic acid)", in Ebnesajjad (ed.) Handbook of biopolymers and biodegradable plastics, Elsevier, Oxford: 11-70. Available at <http://books.google.co.uk/books?id=ohpaDQZF5JcC&pg=PA30&lpg=PA30&dq=Pyramid+Bioplastics+PLA+plant&source=bl&ots=3fScYeGeE1&sig=WLDsMiYNGNdYjpRzviYR8SVDgRM&hl=en&sa=X&ei=MXQZVK-WO8mp7AbnIYGICg&ved=0CEUQ6AEwBA#v=onepage&q=Pyramid%20Bioplastics%20PLA%20plant&f=false>

Uhde Inventa-Fischer (2014) "PLAneo® Process". Available at <http://www.uhde-inventa-fischer.com/polylactic-acid/planeoc2ae-process/>

Verbruggen, M. (2014) "NatureWorks and Ingeo: rethink what you think you know...". Available at http://www.innovationtakesroot.com/~media/ITR2014/2014/presentations/plenary-wed/04_One-Decade-of-Progress_Verbruggen_pdf.pdf

Verlag, G. (2014) "Thailand: NatureWorks expects 2014 decision on Thai Ingeo biopolymer facility". Available at <http://www.gupta-verlag.com/general/news/industry/14880/THAILAND-NatureWorks-expects-2014-decision-on-Thai-Ingeo-biopolymer-facility>

Vink et al. (2010) "The eco-profile for current Ingeo polylactide production", Industrial Biotechnology 6(4): 212-224.

Wintergerste, T. (2012) "Great advances in bioplastics", Sulzer Technical Review 2012 1(1): 13-14. Available at http://www.sulzer.com/en/-/media/Documents/Cross_Division/STR/2012/STR_2012_1_13_14_Wintergerste_e.pdf

Succinic acid

BioAmber (2014) "BioAmber signs take-or-pay contract for three bio-succinic acid plants". Available at <http://investor.bio-amber.com/2014-07-07-BioAmber-Signs-Take-or-Pay-Contract-For-Three-Bio-Succinic-Acid-Plants>

BioAmber (2014) "Life cycle analyses (LCA)". Available at <http://archive.today/WgAeM>

"Canada invests 12 million \$ to support BioAmber Sarnia new bio-based succinic acid plant" (n.d.). Available at <http://www.chinabiobasedtech.com/d276426225.htm>

Chang, J. (2013) "Myriant in talks to build bio-BDO plant in Asia: exec". Available at <http://www.icis.com/resources/news/2013/07/02/9684067/myriant-in-talks-to-build-bio-bdo-plant-in-asia-exec/>

Cok, B., Tsiropoulos, I., Roes, A.L., Patel, M.K. (2013), "Succinic acid production derived from carbohydrates: An energy and greenhouse gas assessment of a platform chemical toward a bio-based economy", *Biofuels, Bioproducts and Biorefining* 8(1): 16-29.

De Guzman, D. (2014), "PTT-MCC signs bio-succinic acid contract with BioAmber". Available at <http://greenchemicalsblog.com/2014/05/19/ptt-mcc-signs-bio-succinic-acid-contract-with-bioamber/>

De Guzman, D. (2012) "To Succinity and beyond!". Available at <http://greenchemicalsblog.com/2012/10/05/to-succinity-and-beyond/>

Dowsett, O. (2013) "Biopolymers industry hampered by production costs". Available at http://resource.co/article/Futurevision/Biopolymers_industry_hampered_production_costs-3680

European Biotechnology News (2012) "Evonik and BioAmber team up". Available at <http://www.european-biotechnology-news.com/news/news/2012-03/evonik-and-bioamber-team-up.html>

Harmsen, P. and Hackmann, M. (2013). "Green building blocks for bio-based plastics: Biobased processes and market development". Available at <http://www.groenegrondstoffen.nl/downloads/Boekjes/16GreenBuildingblocks.pdf>

Kabasci, S. (ed.) (2014), "Bio-based Plastics: Materials and applications", John Wiley & Sons, UK.

LifeSci Advisors (2013) "BioAmber Inc: Initiation of coverage". Available at http://www.lifesciadvisors.com/clientinfo/bioamber/BioAmber_Initiation_Report_10-08-2013_clientinfo.pdf

Reverdia (2014) "Reverdia showcases Biosuccinium™ 100% bio-based succinic acid and underlines its importance for the Chinese plastics market". Available at <http://www.reverdia.com/press-releases/reverdia-showcases-biosuccinium-100-bio-based-succinic-acid-underlines-importance-chinese-plastics-market/>

Ravenscroft, M. (2013) "Industrial biotechnology: Chemical building blocks from renewable resources, IHS Chemical Week. Available at http://www.chemweek.com/lab/Industrial-biotechnology-Chemical-building-blocks-from-renewable-resources_54373.html

Succinity (2014) "Our product: Succinity". Available at http://www.succinity.com/biobased_succinic_acid/our_product/

Succinity (2014) "Succinity produces first commercial quantities of biobased succinic acid". Available at <http://www.succinity.com/news/140303.htm>

Weastra, S.R.O. (2013) "WP 8.1. Determination of market potential for selected platform chemicals: Itaconic acid, Succinic acid, 2,5-Furandicarboxylic acid", Report for BioConSepT FP7 project. Available at http://www.bioconsept.eu/wp-content/uploads/BioConSepT_Market-potential-for-selected-platform-chemicals_report1.pdf

Chapter 6 – Current European industry competitiveness

Competitiveness assessment criteria

Guan, J. C., Yam, R.C.M., Mok C.K., and Ma N. (2006) "A study of the relationship between competitiveness and technological innovation capability based on DEA models", *European Journal of Operational Research* 170: 971–986

Competing regions assessment

- Agritrade (2013) "Impact of CAP reform agreement on the sugar sector". Available at <http://agritrade.cta.int/en/Agriculture/Commodities/Sugar/Impact-of-CAP-reform-agreement-on-the-sugar-sector>
- BESTF (n.d.) "Home". Available at <http://eragnetbestf.net/home/>
- Bio-based Industries Consortium (2014) "About us". Available at <http://bbi-europe.eu/about/about-bbi>
- Bio-based Industries Consortium (2014) "The significance of a global Bio-based Initiative - Realising the European Bio-economy Potential via BBI, a Public Private Partnership on Bio-based Industries". Available at https://www.dsm.com/content/dam/dsm/cworld/en_US/documents/2014-03-04-presentation-significance-of-a-global-bio-based-initiative.pdf
- Centre for Strategy & Evaluation Services (2011) "Final Evaluation of the Lead Market Initiative, The Waste Framework Directive - Waste management in the Flemish region". Available at <http://ec.europa.eu/DocsRoom/documents/5627/attachments/1/translations/en/renditions/native>
- Chiamonti (2013) Leaders of Sustainable Biofuels presentation, 8th May, Brussels
- Comite Europeen des Fabricants de Sucre (2014) "CEFS sugar statistics 2013". Available at <http://www.comitesucre.org/site/wp-content/uploads/2014/04/CEFS-Sugar-Statistics-Inquiry-2013-FINAL-DRAFTv4.pdf>
- Deloitte (2014) "Opportunities for the fermentation-based chemical industry: An analysis of the market potential and competitiveness of North-West Europe". Available at <https://www.rabobank.com/en/images/deloitte-fermentation-study.pdf>
- Deloitte (2013) "Global manufacturing competitiveness index: An in-depth analysis of survey responses". Available at <http://www2.deloitte.com/us/en/pages/manufacturing/articles/2013-global-manufacturing-competitiveness-index.html>
- Dezem, V (2014) "Brazilian Senate Approves Higher Ethanol Mandate", Bloomberg Business. Available at <http://www.bloomberg.com/news/2014-09-03/brazilian-senate-approves-higher-ethanol-mandate.html>
- ePure (2014) "EU Regulations – FQD, RED". Available at <http://www.epure.org/ethanol-for-fuel/eu-regulations>
- European Biofuels Technology Platform (n.d.) "Biofuels and sustainability issues". Available at <http://www.biofuelstp.eu/sustainability.html>
- European Biofuels Technology Platform (n.d.) "EBTP-SABS European Biofuels Technology Platform - Support for Advanced Biofuels Stakeholders". Available at <http://www.biofuelstp.eu/ebtp-sabs.html>
- European Biofuels Technology Platform (n.d.) "European Industrial Bioenergy Initiative (EIBI)". Available at <http://www.biofuelstp.eu/eibi.html>
- European Commission (2014) "Climate action: Commission uses polluters' revenues to fund clean energy projects across Europe". Available at http://europa.eu/rapid/press-release_IP-14-780_en.htm
- European Commission (2014) "Transport & Environment: Fuel quality monitoring". Available at <http://ec.europa.eu/environment/air/transport/fuel.htm>
- European Commission (2013) "Final evaluation of the Lead Market Initiative". Available at http://ec.europa.eu/enterprise/policies/innovation/policy/lead-market-initiative/final-eval_en.htm
- European Commission (2013) "Sugar". Available at http://ec.europa.eu/agriculture/sugar/index_en.htm
- European Commission (2012) "Commission staff working document, *Accompanying the document* Communication on Innovating for Sustainable Growth: A Bioeconomy for Europe", Available at http://ec.europa.eu/research/bioeconomy/pdf/201202_commission_staff_working.pdf

- European Commission (2012) "Questions and answers on the outcome of the first call for proposals under the NER300 programme". Available at [http://europa.eu/rapid/press-release MEMO-12-999_en.htm](http://europa.eu/rapid/press-release_MEMO-12-999_en.htm)
- European Biofuels Technology Platform (n.d.) "R&D&D funding". Available at <http://www.biofuelstp.eu/funding.html>
- European Commission (n.d.) "The EU Emissions Trading Scheme (EU ETS)". Available at http://ec.europa.eu/clima/policies/ets/index_en.htm
- European Commission (n.d.) "NER 300 programme". Available at http://ec.europa.eu/clima/policies/lowcarbon/ner300/index_en.htm
- European Commission (n.d.) "What is Horizon 2020?". Available at <http://ec.europa.eu/programmes/horizon2020/en/what-horizon-2020>
- Fairtrade Foundation (2013) "Fairtrade and sugar, Commodity briefing". Available at [http://www.fairtrade.net/fileadmin/user_upload/content/2009/resources/2013 Fairtrade and Sugar Briefing.pdf](http://www.fairtrade.net/fileadmin/user_upload/content/2009/resources/2013_Fairtrade_and_Sugar_Briefing.pdf)
- Gawander, J. (2013) "EU Sugar Sector Reform and Possible Implications for Fiji and other ACP Sugar Suppliers", SRIF. Available at http://www.srif.net.fj/web_documents/Par1%20EU%20Sugar%20Sector%20reform.pdf
- Harvard Business Review Analytic Services (2013) "Bioeconomy: An agenda for Brazil", Harvard Business Review. Available at http://arquivos.portaldaindustria.com.br/app/conteudo_24/2013/10/18/411/20131018135824537392u.pdf
- International Centre for Trade and Sustainable Development (2013) "European Commission proposes duties on imports of US biofuels". Available at <http://www.ictsd.org/bridges-news/bridges/news/european-commission-proposes-duties-on-imports-of-us-biofuels>
- International Innovation (n.d.) "SusChem – European Technology Platform for Sustainable Chemistry". Available at <http://www.internationalinnovation.com/suschem-european-technology-platform-for-sustainable-chemistry/>
- International Renewable Energy Agency (IRENA) (2012) "Biomass for power generation", Renewable Energy Technologies: Cost Analysis Series. Available at http://www.irena.org/DocumentDownloads/Publications/RE_Technologies_Cost_Analysis-Biomass.pdf
- KPMG (2011) "China's 12th five-year plan (2011-2015)", KPMG Insight Series. Available at <http://www.kpmg.com/cn/en/issuesandinsights/articlespublications/publicationseries/5-years-plan/pages/default.aspx>
- Kuruppallil, Z. (2011), "Green plastics: An emerging alternative for petroleum based plastics?", Proceedings of The 2011 IAJC-ASEE International Conference. Available at http://ijme.us/cd_11/PDF/Paper%2036%20ENT%20202.pdf
- Kutas, G. (2013) "Session 5: Global approaches to support for advanced biofuels - how the need for a comprehensive policy framework is being addressed", Fifth Stakeholder Plenary Meeting of EBTP, Brussels. Available at <http://www.biofuelstp.eu/spm5/pres/kutas.pdf>
- Lane, I. (2013) "European Investment Bank to loan €65M to Biochemtex". Available at <http://www.biofuelsdigest.com/bdigest/2013/12/16/european-investment-bank-to-loan-e65m-to-biochemtex/>
-

- Linfoot, C (2014) "Factsheet: The Brazilian bio-based industry at a glance". Available at <http://www.greenpowerconferences.com/EF/?sSubSystem=Prospectus&sSessionID=5ock61hc8861hb9e006nnml050-12708618&sEventCode=BF1409BR&sDocument=Factsheet>
- NER300.com (2014) "Extensions to NER300 deadlines". Available at <http://www.ner300.com/?p=353>
- OECD (2014) "OECD-FAO Agricultural Outlook 2014-2023". Available at <http://www.oecd.org/site/oecd-faoagriculturaloutlook/>
- OECD (2013) "OECD-FAO Agricultural Outlook 2013-2022". Available at <http://www.oecd.org/site/oecd-faoagriculturaloutlook/highlights-2013-EN.pdf>
- Ortega Shlingmann, F. (2013) "Financing innovative biofuel/bioenergy industrial demonstration plants", 2013 EIBI conference, Brussels. Available at http://www.eusew.eu/upload/events/508_6547_eib.pdf
- Ohlrogge Oliveira, L. (2012) "Brazil's new industrial policy". Available at <http://www.equilibri.net/nuovo/es/node/2041>
- Presidency of the Republic of Brazil (2007) "Decree No. 6,041, OF 8 FEBRUARY 2007. Establishing the Development Policy Biotechnology, creating the National Committee on Biotechnology and other measures", Available at: http://www.mct.gov.br/upd_blob/0016/16386.pdf
- Pugatch Consilium (2014) "Building the Bioeconomy - Examining National Biotechnology Industry Development Strategies, A Briefing Paper". Available at http://www.abiquim.org.br/download/comunicacao/apresentacao/building_the_bioeconomy_pugatch_consilium_april_2014.pdf
- PWC (2013) "Global wage projections to 2030". Available at <http://www.pwc.co.uk/assets/pdf/global-wage-projections-sept2013.pdf>
- Sapp, M. (2014) "BNDES approves \$618 million in loans for cane ethanol innovation". Available at <http://www.biofuelsdigest.com/bdigest/2014/02/18/bndes-approves-618-million-in-loans-for-cane-ethanol-innovation/>
- Schaaper, M. (2009) "Measuring China's innovation system, National specificities and international comparisons", STI Working Paper 2009/1. Available at STI WORKING PAPER 2009/1 <http://www.oecd.org/sti/42003188.pdf>
- Schroeder, J. (2014) "PAISS program to help Brazilian sugarcane industry". Available at <http://domesticfuel.com/2014/02/17/paiss-program-to-help-brazilian-sugarcane-industry/>
- Sugaronline.com (2014) "Thailand: Government approves loan to jumpstart bioplastics industry". Available at http://www.sugaronline.com/website_contents/view/1237127
- SusChem (n.d.) "Impact of SusChem: SusChem and the European Research & Innovation Agenda". Available at <http://www.suschem.org/about-suschem/impact-of-suschem.aspx>
- The White House (2012) "National Bioeconomy Blueprint". Available at http://www.whitehouse.gov/sites/default/files/microsites/ostp/national_bioeconomy_blueprint_april_2012.pdf
- United States Department of Agriculture Rural Development (n.d.) "Bio-refinery Assistance Program Guaranteed Loans (9003)". Available at http://www.rurdev.usda.gov/supportdocuments/sc_9003.pdf
- United States Department of Agriculture Farm Service Agency (2014) "FSA biomass crop assistance program". Available at <https://www.fsa.usda.gov/FSA/webapp?area=home&subject=ener&topic=bcap>
- United States Department of Agriculture (2014) "BioPreferred", Available at: <http://www.biopreferred.gov/BioPreferred/faces/Welcome.xhtml>
-

United States Congress (2005) "Energy Policy Act of 2005", Available at:

http://energy.gov/sites/prod/files/2013/10/f3/epact_2005.pdf

United States Department of Energy (2014) "Loan guarantee solicitation announcement – Federal loan guarantees for renewable energy". Available at

<http://energy.gov/sites/prod/files/2014/07/f17/Renewable%20Energy%20and%20Efficient%20Energy%20Projects%20Solicitation%20FINAL.pdf>

United States Environmental Protection Agency (2014) "Renewable Fuel Standard (RFS)". Available at

<http://www.epa.gov/oms/fuels/renewablefuels/>

Wubbolts, M. (2014) "The significance of a global bio-based initiative, Realising the European bio-economy potential via BBI, a public private partnership on bio-based Industries". Available at

https://www.dsm.com/content/dam/dsm/cworld/en_US/documents/2014-03-04-presentation-significance-of-a-global-bio-based-initiative.pdf

Yue, T. (2013) "Regulatory landscape and sustainability concerns for biofuels in China", Maastricht University. Available at [http://www.energy-](http://www.energy-trans.de/downloads/Regulatory_Landscape_and_Sustainability_Concerns_for_Biofuels_in_China.pdf)

[trans.de/downloads/Regulatory_Landscape_and_Sustainability_Concerns_for_Biofuels_in_China.pdf](http://www.energy-trans.de/downloads/Regulatory_Landscape_and_Sustainability_Concerns_for_Biofuels_in_China.pdf)

Chapter 7 – Assessment of technology opportunities and barriers

Pre-treatment of lignocellulosic biomass

Alvira, P., E. Tomas-Pejo, et al. (2009). "Pretreatment technologies for an efficient bioethanol production process based on enzymatic hydrolysis: A review." *Bioresource Technology*

Bloomberg (2013) "Highlights: Cellulosic ethanol costs", Bloomberg New Energy Finance Industry Survey, 2013. Presentation by Claire Currey, 05 April 2013

Carrillo, F., M. J. Lis, et al. (2005). "Effect of alkali pretreatment on cellulase hydrolysis of wheat straw: Kinetic study." *Process Biochemistry* 40(10): 3360-3364.

Carvalho, F., Duarte, L.C and F.M. Girio (2008) " Hemicellulose biorefineries: a review on biomass pretreatments", *Journal of Scientific & Industrial Research* Vol. 67, November 2008, pp.849-864

Chiaromonti, D., Prussi, M., Ferrero, S., Oriani, L., Ottonello, P., Torre, P., Cherchi, F. (2012) "Review of pretreatment processes for lignocellulosic ethanol production, and development of an innovative method". *Biomass and Bioenergy*, 42, 25-35.

DuPont (2014) "Building a secure energy future", Available at: biosciences.dupont.com/global-challenges/energy/ [Accessed 20/07/14]

Garcia, A., Alriols, M.G. and J. Labidi (2014) " Evaluation of different lignocellulosic raw materials as potential alternative feedstocks in biorefinery processes" *Industrial Crops and Products* 53 (2014) 102– 110

Harmsen, P.F.H. , Huijgen, W. , Bermudez, L. , Bakker, R. (2010). Literature review of physical and chemical pretreatment processes for lignocellulosic biomass (2010) Wageningen : Wageningen UR Food & Biobased Research, 2010 (Rapport 1184) - ISBN 9789085857570 - 54 p.

Harmsen, P.F.H.; Lips, S.J.J.; Bakker, R.R.C.. (2013) Pretreatment of lignocellulose for biotechnological production of lactic acid, Wageningen UR FBR, 2013 (Rapport / Food and Biobased Research 1384) - ISBN 9789461736079

Hendriks, A. T. W. M. and G. Zeeman (2008). "Pretreatments to enhance the digestibility of lignocellulosic biomass." *Bioresource Technology* 100(1): 10-18.

- Hong et al (2013) "Impact of cellulase production on environmental and financial metrics for lignocellulosic ethanol", *Biofuels, Bioproducts, Biorefinery* 7:303-313
- Kumar P., Barrett D.M., Delwiche, M.J., Stroeve P. (2009) "Methods for pretreatment of lignocellulosic biomass for efficient hydrolysis and biofuel production", *Industrial & Engineering Chemistry Research* 48(1): 3713–3729
- Lin, Y. and Tanaka, S. (2006) "Ethanol fermentation from biomass resources: current state and prospects", *Applied Microbiology & Biotechnology* 69(1): 627–642
- Lui, Z. and B. Fei (2013) "Sustainable Degradation of Lignocellulosic Biomass - Techniques, Applications and Commercialization", *Biochemistry, Genetics and Molecular Biology*, book edited by Anuj K. Chandel and Silvio Silvério da Silva, ISBN 978-953-51-1119-1, Published: May 15, 2013
- Mosier, N., C. Wyman, et al. (2005). "Features of promising technologies for pretreatment of lignocellulosic biomass." *Bioresource Technology* 96(6): 673-686.
- Novozymes (2014) "Cellulosic ethanol", Available at: www.novozymes.com/en/solutions/bioenergy/cellulosic-ethanol/Pages/default.aspx [Accessed 20/07/14]
- Roderick B. V. (2013) "A review of biomass utilization in a Northern European context" University of Wageningen, *MSc Thesis Management studies*, arbornwe.eu/downloads
- Sánchez, O.J., and Cardona, C.A. (2008), "Trends in biotechnological production of fuel ethanol from different feedstocks", *Bioresource Technology* 99(1): 5270-5295.
- Taherzadeh, M. J. and K. Karimi (2008). "Pretreatment of lignocellulosic wastes to improve ethanol and biogas production: A review." *International Journal of Molecular Sciences* 9(9): 1621-1651.
- van Groenestijn, J., Hazewinkel, O., and Bakker, R. (2006). "Pretreatment of lignocellulose with biological acid recycling (Biosulfurol process)", *Zuckerindustrie* 131(9), 639-641.

Downstream conversion of sugars

- Babu, R.P., O'Connor, K. and Seeram, R. (2013). "Current progress on bio-based polymers and their future trends" *Progress in Biomaterials* 2(8).
- Balan V, Chiaramonti D, Kumar S. (2013) "Review of US and EU initiatives toward development, demonstration, and commercialization of lignocellulosic biofuels". *Biofuels, Bioprod. Bioref.* doi: 10.1002/bbb.1436
- BIOCORE (2013). Building tomorrow's biorefineries. Findings from case studies performed in the framework of the FP7 project BIOCORE (www.biocore-europe.org).
- BioREF-iNTEG (2010) "Identification and market analysis of most promising added-value products to be co-produced with the fuels", Deliverable 2 total, FP7 project. Available at: http://www.bioref-integ.eu/fileadmin/bioref-integ/user/documents/D2total_including_D2.1_D2.2_D2.3_.pdf
- BIOENERGY (2010). Biorefinery developments for Europe: Results of the integrated project BIOENERGY 2007-2010.
- Bolck, C., Ravensteijn, J., Molenveld, K., Harmsen, P. *Biobased Plastics 2012*. www.groenegrondstoffen.nl
- Breitkreuz, K., A. Menne and A. Kraft (2014). "New process for sustainable fuels and chemicals from bio-based alcohols and acetone.", *Biofuels, Bioproducts and Biorefining* 8(4): 504-515.
- de Jong, E and R. J. A. Gosselink (2014) Ligno-cellulose-based chemical products. In book: *Bioenergy Research: Advances and Applications*, Chapter: 17, Publisher: Elsevier, Amsterdam, the Netherlands, Editors: Gupta, V.K., Kubicek, C.P., Saddler, J, Xu, F, Tuohy, M.G., pp.277-313

de Jong, E, Higson A, Walsh P, Wellisch M, (2012b) "Product developments in the bio-based chemicals arena", *Biofuels, Bioproducts and Biorefining*, 6(6):606-24.

Green, E. M. (2011). "Fermentative production of butanol—the industrial perspective." *Curr Opin Biotech* 23: 337-343.

Harmsen, P. F. H., M. M. Hackmann and H. L. Bos (2014). "Green building blocks for bio-based plastics." *Biofuels, Bioproducts and Biorefining* 8(3): 306-324.

Harmsen, P. and M. Hackmann (2013) "Green building block for biobased plastics", Available at: http://www.iea-bioenergy.task42-biorefineries.com/upload_mm/d/7/6/54c63506-4be9-4892-b5b2-7b658c10305e_GreenBuildingBlocks%20for%20Biobased%20Plastics%20HR.pdf

Mascoma website (2014), Retrieved 22nd July 2014, from <http://www.mascoma.com>

Metabolic explorer (2014) "METabolic EXplorer", Available at: <http://www.metabolic-explorer.com/>

K. Molenveld, personal communication

Nature Works, personal communication

Posada Duque, J. A. *et-al* (2014). A biorefinery in Rotterdam with isobutanol as platform molecule. *NPT process technology*. Amersfoort (The Netherlands), Professional media group Nederland. 2: 24-25 (online, npt.pmg.nl)

Prakasham, R. S., R. S. Rao and P. J. Hobbs (2009). "Current trends in biotechnological production of xylitol and future prospects." *Curr trends biotech pharmacy* 3(1) p..

Sreekumar, S., Z. C. Baer, E. Gross, S. Padmanaban, K. Goulas, G. Gunbas, S. Alayoglu, H. W. Blanch, D. S. Clark and F. D. Toste (2014). "Chemocatalytic Upgrading of Tailored Fermentation Products Toward Biodiesel." *ChemSusChem*: online

Star-COLIBRI (2010) "D 2.1 Background information and biorefinery status, potential and sustainability – Task 2.1.2 Market and Consumers; Carbohydrates", Authors: Bos, Harmsen & Annevelink (WUR FBR), Available at: <http://www.star-colibri.eu/files/files/Deliverables/D2.1-Report-19-04-2010.pdf>

Straathof (2014) "Transformation of biomass into commodity chemicals using enzymes or cells", *Chem. Rev.*, 2014, 114 (3), pp 1871–1908. Available at: <http://pubs.acs.org/doi/abs/10.1021/cr400309c>

Weastra (2013). WP 8 .1 . Determination of market potential for selected platform chemicals itaconic acid, succinic acid, 2,5-furandicarboxylic acid.

Weastra (2013). "WP 8.1. Determination of market potential for selected platform chemicals", report for BioConSepT FP7 project, Report available at: http://www.bioconcept.eu/wp-content/uploads/BioConSepT_Market-potential-for-selected-platform-chemicals_report1.pdf Executive summary available at: http://www.bioconcept.eu/wp-content/uploads/BioConSepT_Market-potential-for-selected-platform-chemicals_ppt1.pdf [Accessed 08/07/14]

Chapter 8 – R&D gaps and industry needs

Technical gaps in research and target R&D solutions

BIOCORE (2014) "The Biocore Project", Available at <http://www.biocore-europe.org/> [Accessed 16/01/15]

Non-technical deployment gaps and targeted solutions

Bio-TIC (2014) “Overcoming hurdles for innovation in industrial biotechnology in Europe: Non-Technological Roadmap: Draft 2”, Available at: <http://www.industrialbiotech-europe.eu/bio-roadmaps/non-technological/>

Bio-TIC (2014) “Overcoming hurdles for innovation in industrial biotechnology in Europe: Non-Technological Roadmap: Draft 2, Executive Summary”, Available at: http://www.industrialbiotech-europe.eu/wordpress/wp-content/uploads/2014/04/Executive-Summary-of-Non-Technological-Roadmap_Draft-2_April-2014.pdf

E4tech (2014) “Advanced Biofuel Feedstocks – An Assessment of Sustainability”, Available at https://www.gov.uk/government/uploads/system/uploads/attachment_data/file/277436/feedstock-sustainability.pdf

EurActiv Network (2014) “Europe’s ‘historic moment’ on plastics bags contested by industry advocates”, Available at <http://www.euractiv.com/sections/sustainable-dev/europes-historic-moment-plastics-bags-contested-industry-advocates-310336>

European Bioplastics (2014) “EU legislation on plastic bags paves way for compostable shopping bags”, Available at http://en.european-bioplastics.org/wp-content/uploads/2014/pr/EUBP_PR_EU_approves_bag_reduction_141125.pdf

European Commission (2012) “Commission staff working document: Communication on Innovating for Sustainable Growth: A Bioeconomy for Europe”, Available at http://ec.europa.eu/research/bioeconomy/pdf/201202_commission_staff_working.pdf

European Commission (n.d.) “What is the bioeconomy”, Available at <http://ec.europa.eu/research/bioeconomy/>

European Investment Fund (2015) “InnovFin SME Guarantee Facility”, Available at http://www.eif.org/what_we_do/guarantees/single_eu_debt_instrument/innovfin-guarantee-facility/index.htm

European Investment Fund (2015) “Risk Sharing Instrument (RSI)”, Available at http://www.eif.org/what_we_do/guarantees/RSI/

IHS (2014) “Bio-based Chemicals Getting Unexpected Boost from Shale Gas Boom in North America”, Available at <http://press.ihs.com/press-release/bio-based-chemicals/bio-based-chemicals-getting-unexpected-boost-shale-gas-boom-north->

Jogdand (2014) “Current Status of bio-based chemicals”, Available at <http://www.slideshare.net/induniva/current-status-of-biobased-chemicals>

McCormick, K., and Kautto, N. (2013) “The Bioeconomy in Europe: An Overview”, Sustainability 5(1): 2589-2608. Available at <http://www.mdpi.com/2071-1050/5/6/2589/pdf>

Standing Committee on Agricultural Research Strategic Working Group (2014) “Where next for the European bioeconomy?”, European Commission, Available at http://ec.europa.eu/research/bioeconomy/pdf/where-next-for-european-bioeconomy-report-0809102014_en.pdf

Appendix A– Literature review

Some of the sources can be found in other chapters

- Babu, R.P., O'Connor, K. and Seeram, R. (2013). "Current progress on bio-based polymers and their future trends" *Progress in Biomaterials* 2(8).
- Balan V, Chiaramonti D, Kumar S. (2013) "Review of US and EU initiatives toward development, demonstration, and commercialization of lignocellulosic biofuels". *Biofuels, Bioprod. Bioref.* doi: 10.1002/bbb.1436
- Bos, H.L.; Conijn, J.G.; Corre, W.J.; Meesters, K.P.H.; Patel, M.K. (2010) "Sustainability aspects of biobased applications: Comparison of different crops and products from the sugar platform", *Wageningen UR, FBR report 1166*
- Bos H.L., Meesters K.P.H., Conijn S.G., Corré W.J., Patel M.K. (2012) "Accounting for the constrained availability of land: a comparison of bio-based ethanol, polyethylene and PLA with respect to non-renewable energy use and land use"; *Biofuels, Bioprod, Bioref*, 6; 146-158, doi: 10.1002/bbb.1320
- Bos H.L., Sanders J.P.M. (2013) "Raw materials demand and sourcing options for the development of a biobased economy industry in Europe. Part 1: Estimation of maximum demand"; *Biofuels, Bioprod, Bioref*, 7; 246-259 doi: 10.1002/bbb.1388
- Harmsen, P.F.H.; Huijgen, W.; Bermudez, L.; Bakker, R. (2010) "Literature review of physical and chemical pretreatment processes for lignocellulosic biomass", Available at <http://edepot.wur.nl/150289>
- Chiaramonti, D., Rizzo, A.M., Prussi, M., Tedeschi, S., Zimbardi, F., Braccio, G., Viola, E. and P.T. Pardelli (2011) "2nd generation lignocellulosic bioethanol: is torrefaction a possible approach to biomass pretreatment?" *Journal of Biomass Conversion and Biorefinery* Volume 1, pp. 9-15, DOI: 10.1007/s13399-010-0001-z
- Kretschmer, B., *et al.* (2013). "Recycling agricultural, forestry & food wastes and residues for sustainable bioenergy and biomaterials", Available at: http://www.europarl.europa.eu/RegData/etudes/etudes/join/2013/513513/IPOL-JOIN_ET%282013%29513513%28SUM01%29_EN.pdf [Accessed 08/07/14]
- Nova Institute (2013). "Market study on Bio-based Polymers in the World: Capacities, Production and Applications: Status Quo and Trends towards 2020", Available at: http://www.bio-based.eu/market_study/ [Accessed 08/07/14]
- Nova Institute (2012). "World-wide Investments in Bio-based Chemicals", Available at: <http://bit.ly/1u5mOPm> [Accessed 08/07/14]
- European Commission (2012). "Strategy for 'Innovating for Sustainable Growth: A Bioeconomy for Europe'", Available at http://ec.europa.eu/research/bioeconomy/pdf/201202_innovating_sustainable_growth_en.pdf [Accessed 08/07/14]
- Falano, T.O. (2012). "Sustainability Assessment of Integrated Bio-refineries", DPhil Thesis, Available at: <https://www.escholar.manchester.ac.uk/api/datastream?publicationPid=uk-ac-man-scw:183555&datastreamId=FULL-TEXT.PDF> [Accessed 08/07/14]
- Jungmeier, G., *et al.* (2013). "Biofuel-driven Biorefineries: A selection of the most promising biorefinery concepts to produce large volumes of road transportation biofuels by 2025", report for IEA Bioenergy Task 42, Available at: http://www.nachhaltigwirtschaften.at/iea_pdf/iea_task_42_biofuel_driven_biorefineries_lr.pdf [Accessed 08/07/14]
- IEA (2013) "TASK 42 Biorefineries: Co-production of Fuels, Chemicals, Power and Materials from Biomass", Available at: http://www.iea-bioenergy.task42-biorefineries.com/upload_mm/b/f/a/4898a5a0-ed3b-435e-bec3-17d297957f60_Final%20Report%20IEA%20Bioenergy%20Task42%20Triennium%202010%202012.pdf

Maniatis K. and D. Chiamonti (2012) "Framework and perspectives of industrial lignocellulosic ethanol deployment: Introduction to the 1st International Conference on Lignocellulosic Ethanol" *Biomass & Bioenergy*, vol. 46, p. 1-4, ISSN: 0961-9534, doi:10.1016/j.biombioe.2012.10.001

Rettenmaier, N., *et al.* (2013). "Environmental sustainability assessment of the BIOCORE biorefinery concept (D 7.5)", Available at: http://www.biocore-europe.org/file/D7_5%20Environmental%20sustainability%20assessment%20of%20the%20BIOCORE%20biorefinery%20concept.pdf [Accessed 08/07/14]

Scott, E.L., Bruins, M.E. and Sanders, J.P.M. (2013). "Rules for the bio-based production of bulk chemicals on a small scale", Available at: <http://www.biobasedeconomy.nl/wp-content/uploads/2011/08/Can-production-of-bulk-chemicals-on-a-small-scale-be-competative-formated-20131126FINAL.pdf> [Accessed 08/07/14]

Star-COLIBRI (2010) "D 2.1 Background information and biorefinery status, potential and sustainability – Task 2.1.2 Market and Consumers; Carbohydrates", Authors: Bos, Harmsen & Annevelink (WUR FBR), Available at: <http://edepot.wur.nl/158542>

Appendix C – Assessment of suitable feedstocks

Bocchini Martins D.A. Ferreira Alves do Prado H., Ribeiro Leite R.S., Ferreira H., de Souza Moretti M.M., da Silva R. and Gomes E. (2011) Agroindustrial Wastes as Substrates for Microbial Enzymes Production and Source of Sugar for Bioethanol Production. *Integrated Waste Management* Volume 2 Chapter 17

ECN (2014) "Phyllis2", Available at: <https://www.ecn.nl/phyllis2/>

EPA (2007) Biomass Combined Heat and Power Catalog of Technologies Combined Heat and Power Partnership. *CHP catalogues*: Part 3 Biomass

García A., Alriols M. G. and J. Labidi (2014) Evaluation of different lignocellulosic raw materials as potential alternative feedstocks in biorefinery processes. *Industrial Crops and Products* **53** :102– 110

Gavrilescu D. (2008) Energy from biomass in pulp and paper mills. *Environmental Engineering and Management Journal* **7**: 537-546

Goering H.K. and Van Soest P.J (1970) Forage fiber analysis. *Agriculture Handbook* No. 379. *US Department of Agriculture*.

Gonzalez-Garcia S., Gasol C.M., Gabarrell X., Rieradevall J., Moreira M.T. and Feijoo G.(2010)Environmental profile of ethanol from poplar biomass as transport fuel in Southern Europe. *Renewable Energy* **35**:1014–1023

Hogg D., Barth J., Favoino E., Dealing With Food Wastes in the UK. Report for WRAP (2007). *Eunomia research and consulting* <http://www.biomassenergycentre.org.uk/>

IEA (2014) "BioBank Databases", Available at: <http://www.ieabcc.nl/database/biomass.php>

Karampanis E. and P. Grammelis (2012) Fuel Analysis. *BYSIPLAN handbook*, Available at: http://bisyplan.bioenarea.eu/fuel_appendix.html

Krogell J., Korotkova E., Eränen K., Pranovich A., Salmi T., Murzin D. and Willför S. (2013) Intensification of hemicellulose hot-water extraction from spruce wood in a batch extractor – Effects of wood particle size. *Bioresource Technology* **143** 212–220

Kumar P., Barrett D.M., Delwiche, M.J., Stroeve P. (2009) "Methods for pretreatment of lignocellulosic biomass for efficient hydrolysis and biofuel production", *Industrial & Engineering Chemistry Research* **48**(1): 3713–3729

- Lin, Y. and Tanaka, S. (2006) “Ethanol fermentation from biomass resources: current state and prospects”, *Applied Microbiology & Biotechnology* 69(1): 627–642
- NCASI (2004) “Critical review of forest products decomposition in municipal solid waste landfills”. Available at <http://www.ncasi.org/Downloads/Download.ashx?id=3158>
- NREL (2014), “Glossary of Biomass Terms”, Available at: <http://www.nrel.gov/biomass/glossary.html> [Accessed 31/06/14]
- Pokhrel D. and Viraraghavan T. (2004) Treatment of pulp and paper mill wastewater—a review. *Science of the Total Environment* **333** : 37– 58
- Potters, G., Van Goethem, D. & Schutte, F. (2010) Promising Biofuel Resources: Lignocellulose and Algae. *Nature Education* 3(9):14
- Qin, C., Clarke, K. and K. Li (2014) “Interactive forces between lignin and cellulase as determined by atomic force microscopy”, *Biotechnology for Biofuels* 2014, 7:65. Available at: <http://www.biotechnologyforbiofuels.com/content/pdf/1754-6834-7-65.pdf>
- Roderick B. V. (2013) “A review of biomass utilization in a Northern European context” University of Wageningen, *MSc Thesis Management studies*, arbornwe.eu/downloads
- Saidur R., Abdelaziz E.A., Demirbas A., Hossain M.S. and S. Mekhilef (2011) A review on biomass as a fuel for boilers. *Renewable and Sustainable Energy Reviews* **15**: 2262–2289
- Sánchez, O.J., and Cardona, C.A. (2008), “Trends in biotechnological production of fuel ethanol from different feedstocks”, *Bioresource Technology* 99(1): 5270-5295.
- Zheng, B., Richards, D. J., Smallman D.J., Beaven, R.P. (2007) “Assessing MSW degradation by BMP and fibre analysis”, *Proceedings of the ICE - Waste and Resource Management*, Volume 160, Issue 4, pages 133 –139

Appendix D – Potential impacts of lower crude oil prices

- IHS (2014) “Bio-based chemicals getting unexpected boost from shale gas boom in North America”. Available at <http://press.ihs.com/press-release/bio-based-chemicals/bio-based-chemicals-getting-unexpected-boost-shale-gas-boom-north->
- Jogdand (2014) “Current Status of bio-based chemicals”. Available at <http://www.slideshare.net/induniva/current-status-of-biobased-chemicals>
- Werpy, T. and Petersen, G. (2004) “Top value added chemicals from biomass: Volume I— Results of screening for potential candidates from sugars and synthesis gas”, US DOE report produced by PNNL, NREL and EERE. Available at <http://www1.eere.energy.gov/bioenergy/pdfs/35523.pdf>
- Ray, S., Goldar, A. and S. Saluja (2014) “Feedstock for the Petrochemical industry”, Working Paper ICRIER, Available at: http://icrier.org/pdf/working_paper_271.pdf

Appendix E – Safety issues regarding use of micro-organisms in biofuels processing

- Commissie Genetische Modificatie (COGEM) (2011) “Survey on the implementation of Directive 2009/41/EC”. Available at <http://www.cogem.net/index.cfm/en/publications/publicatie/survey-on-the-implementation-of-directive-2009-41-ec>
- Damien Plan, D. and Van den Eede, G. (2010) “The EU legislation on GMOs: An overview”, JRC Institute for Health and Consumer Protection. Available at

http://publications.jrc.ec.europa.eu/repository/bitstream/111111111/14655/1/reqno_jrc57223_2010-08-12_eu_gmo_legislation_report_final.pdf%5b1%5d.pdf

Jones, D.T. and Woods, D.R. (1986) "Acetone-butanol fermentation revisited", *Microbiological reviews*, 50 (4): 484–524.

OECD (1992), "Safety considerations for biotechnology", Available at <http://www.oecd.org/science/biotech/2375496.pdf>

Okano, K., Tanaka, T., Ogino, C., Fukuda, H., Kondo, A. (2010) "Biotechnological production of enantiomeric pure lactic acid from renewable resources: Recent achievements, perspectives, and limits", *Applied Microbiology and Biotechnology*, 85(1):413–423.

Schuster, E., Dunn-Coleman, N., Frisvad, J.C., van Dijck, P.W.M. (2002) "On the safety of *Aspergillus niger* – a review", *Applied Microbiology and Biotechnology*, 59(2):426–435.

US EPA (1997) "Aspergillus niger final risk assessment", Environmental Protection Agency. Available at http://www.epa.gov/biotech_rule/pubs/fra/fra006.htm

Appendix F – Develop criteria for assessing socio-economic impacts on local communities

Roundtable of Sustainable Biomaterials (RSB) (n.d.) "RSB guidelines, RSB compliance indicators". Available at <http://rsb.org/sustainability/rsb-tools-guidelines/>